ADVANTEST[®]
ADVANTEST CORPORATION

R3267 Series OPT62
3GPP Measurement Option
Operation Manual

MANUAL NUMBER FOE-8370669G00

Applicable Models

R3264
R3267
R3273

Safety Summary

To ensure thorough understanding of all functions and to ensure efficient use of this instrument, please read the manual carefully before using. Note that Advantest bears absolutely no responsibility for the result of operations caused due to incorrect or inappropriate use of this instrument.

If the equipment is used in a manner not specified by Advantest, the protection provided by the equipment may be impaired.

- **Warning Labels**

Warning labels are applied to Advantest products in locations where specific dangers exist. Pay careful attention to these labels during handling. Do not remove or tear these labels. If you have any questions regarding warning labels, please ask your nearest Advantest dealer. Our address and phone number are listed at the end of this manual.

Symbols of those warning labels are shown below together with their meaning.

DANGER: Indicates an imminently hazardous situation which will result in death or serious personal injury.

WARNING: Indicates a potentially hazardous situation which will result in death or serious personal injury.

CAUTION: Indicates a potentially hazardous situation which will result in personal injury or a damage to property including the product.

- **Basic Precautions**

Please observe the following precautions to prevent fire, burn, electric shock, and personal injury.

- Use a power cable rated for the voltage in question. Be sure however to use a power cable conforming to safety standards of your nation when using a product overseas.
- When inserting the plug into the electrical outlet, first turn the power switch OFF and then insert the plug as far as it will go.
- When removing the plug from the electrical outlet, first turn the power switch OFF and then pull it out by gripping the plug. Do not pull on the power cable itself. Make sure your hands are dry at this time.
- Before turning on the power, be sure to check that the supply voltage matches the voltage requirements of the instrument.
- Be sure to plug the power cable into an electrical outlet which has a safety ground terminal. Grounding will be defeated if you use an extension cord which does not include a safety ground terminal.
- Be sure to use fuses rated for the voltage in question.
- Do not use this instrument with the case open.
- Do not place objects on top of this product. Also, do not place flower pots or other containers containing liquid such as chemicals near this product.

Safety Summary

- When the product has ventilation outlets, do not stick or drop metal or easily flammable objects into the ventilation outlets.
- When using the product on a cart, fix it with belts to avoid its drop.
- When connecting the product to peripheral equipment, turn the power off.

- **Caution Symbols Used Within this Manual**

Symbols indicating items requiring caution which are used in this manual are shown below together with their meaning.

DANGER: Indicates an item where there is a danger of serious personal injury (death or serious injury).

WARNING: Indicates an item relating to personal safety or health.

CAUTION: Indicates an item relating to possible damage to the product or instrument or relating to a restriction on operation.

- **Safety Marks on the Product**

The following safety marks can be found on Advantest products.

 : ATTENTION - Refer to manual.

 : Protective ground (earth) terminal.

 : DANGER - High voltage.

 : CAUTION - Risk of electric shock.

- **Replacing Parts with Limited Life**

The following parts used in the instrument are main parts with limited life.

Replace the parts listed below after their expected lifespan has expired.

Note that the estimated lifespan for the parts listed below may be shortened by factors such as the environment where the instrument is stored or used, and how often the instrument is used.

The parts inside are not user-replaceable. For a part replacement, please contact the Advantest sales office for servicing.

There is a possibility that each product uses different parts with limited life. For more information, refer to Chapter 1.

Main Parts with Limited Life

Part name	Life
Unit power supply	5 years
Fan motor	5 years
Electrolytic capacitor	5 years
LCD display	6 years
LCD backlight	2.5 years
Floppy disk drive	5 years

- **Hard Disk Mounted Products**

The operational warnings are listed below.

- Do not move, shock and vibrate the product while the power is turned on.
Reading or writing data in the hard disk unit is performed with the memory disk turning at a high speed. It is a very delicate process.
- Store and operate the products under the following environmental conditions.
An area with no sudden temperature changes.
An area away from shock or vibrations.
An area free from moisture, dirt, or dust.
An area away from magnets or an instrument which generates a magnetic field.
- Make back-ups of important data.
The data stored in the disk may become damaged if the product is mishandled. The hard disc has a limited life span which depends on the operational conditions. Note that there is no guarantee for any loss of data.

- **Precautions when Disposing of this Instrument**

When disposing of harmful substances, be sure dispose of them properly with abiding by the state-provided law.

- Harmful substances:
- (1) PCB (polycarbon biphenyl)
 - (2) Mercury
 - (3) Ni-Cd (nickel cadmium)
 - (4) Other
Items possessing cyan, organic phosphorous and hexadic chromium and items which may leak cadmium or arsenic (excluding lead in solder).

Example: fluorescent tubes, batteries

Environmental Conditions

This instrument should be only be used in an area which satisfies the following conditions:

- An area free from corrosive gas
- An area away from direct sunlight
- A dust-free area
- An area free from vibrations

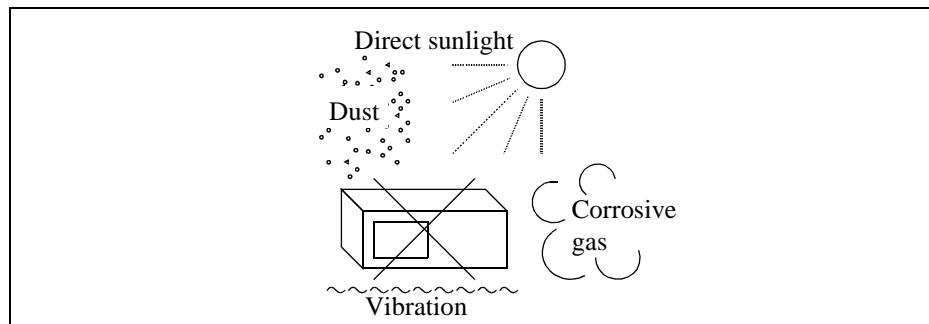

Figure-1 Environmental Conditions

- Operating position

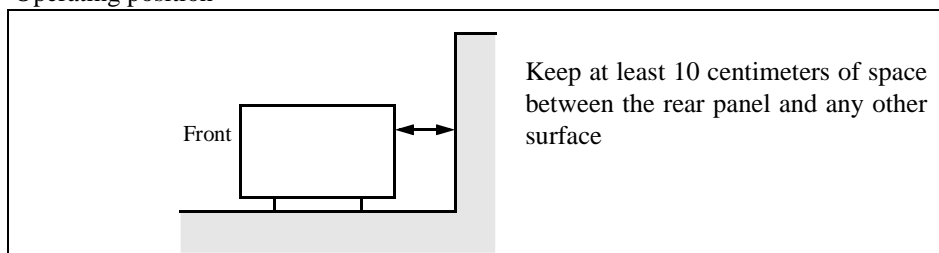

Figure-2 Operating Position

- Storage position

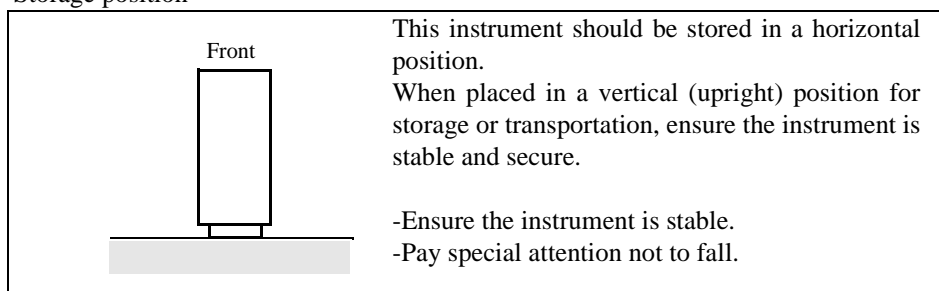

Figure-3 Storage Position

This instrument can be used safely under the following conditions:

- Altitude of up to 2000 m
- Installation Categories II
- Pollution Degree 2

PREFACE

This manual provides the information necessary to check functionality, operate and program the R3267 Series Option 62, 3GPP measurement.

(1) Organization of this manual

This manual consists of the following chapters:

Safety Summary	To use the analyzer safely, be sure to read this manual first.
1. Introduction <ul style="list-style-type: none"> • Product Description (Option) • Standard Accessories • Self Test Error • Connectors on the rear panel 	Includes a description of the option and its' parts and a self test error.
2. Operation	You can learn the basic operations of the option through the examples shown in this chapter.
3. Reference <ul style="list-style-type: none"> • Menu Index • Menu Map • Functional Description 	Shows a list of operation keys, and describes the function of each key.
4. Remote Control <ul style="list-style-type: none"> • GPIB 	Included are a list of commands necessary for programming.
5. Technical Information <ul style="list-style-type: none"> • Template Edit Function • Measurement Parameter Settings in Due to Transient, Due to Modulation and Inband Spurious • Mag Error (Magnitude Error) • Phase Error • E.V.M. (Error Vector Magnitude) • About a ρ • About a Code Domain Power coefficient • About the Carrier Frequency Error of QPSK • Block Diagram 	Describes the principle of operation necessary for taking measurements more accurately.
6. Performance Verification Test	Describes how to test performance.
7. Specifications	Shows the specifications of the option.
APPENDIX <ul style="list-style-type: none"> • Messages 	If an error occurs during operation, an error number and its corresponding error message are displayed. The meaning of each error is explained in this section.

(2) Typeface conventions used in this manual

- Panel keys and soft keys are printed in a contrasting typeface to make them stand out from the text as follows:

Panel keys: Boldface type

Example: **TRANSIENT**

Soft keys: Boldface and italic type

Example: ***T-Domain, Detector***

- When a series of key operations are described using a comma between two keys.
- There are various soft menus used to switch between two states such as ON/OFF and AUTO/MNL. For example, when turning off the **Window ON/OFF** function, the annotation “**Window ON/OFF(OFF)**” is used.

TABLE OF CONTENTS

1	INTRODUCTION	1-1
1.1	Product Overview	1-1
1.2	Accessories	1-1
1.3	Self Test Function	1-1
1.4	About Calibration	1-1
1.5	Explanation of the Connectors	1-2
2	MEASUREMENT EXAMPLES	2-1
2.1	Measuring the BTS 3GPP Signals	2-1
2.1.1	Measuring the Slot	2-1
2.1.2	Measuring the Frame	2-6
2.2	Measuring the MS 3GPP Signal	2-9
2.2.1	Measuring the Slot	2-9
2.2.2	Measuring of the Frame	2-13
2.3	Graphical Display of 3GPP Measurements	2-16
2.4	Measuring a QPSK Signal	2-21
2.5	Power vs Time	2-24
2.5.1	Measuring Power Variations Using the External Trigger	2-24
2.5.2	Measuring Power Variations Using the IF Trigger	2-27
2.6	CCDF Measurement	2-31
2.7	Measuring Primary CPICH Power	2-35
3	REFERENCE	3-1
3.1	Menu Index	3-1
3.2	Menu Map	3-7
3.3	Functional Description	3-26
3.3.1	Switching Communication Systems	3-27
3.3.2	T-Domain	3-28
3.3.2.1	Power (T-Domain)	3-28
3.3.2.2	ON/OFF Ratio	3-31
3.3.2.3	Spurious (T-Domain)	3-34
3.3.3	F-Domain	3-37
3.3.3.1	Power (F-Domain)	3-37
3.3.3.2	OBW	3-40
3.3.3.3	Due to Transient	3-42
3.3.3.4	Due to Modulation	3-45
3.3.3.5	Inband Spurious (1)	3-49
3.3.3.6	Inband Spurious (2)	3-52
3.3.3.7	Outband Spurious	3-55
3.3.4	Modulation	3-57
3.3.4.1	3GPP	3-57

Table of Contents

3.3.4.2 QPSK	3-76
3.3.4.3 Power	3-79
3.3.4.3.1 Tx Power	3-79
3.3.4.3.2 Power vs Time	3-80
3.3.4.3.3 CCDF	3-83
3.3.4.3.4 P-CPICH Power	3-84
3.3.4.4 Time & FFT	3-86
3.3.4.5 STD	3-87
4 REMOTE CONTROL	4-1
4.1 GPIB Command Index	4-1
4.2 GPIB Command Codes	4-10
5 TECHNICAL INFORMATION	5-1
5.1 Template Edit Function	5-1
5.1.1 Template Setting in the T-Domain Measuring Mode	5-1
5.1.2 Template Setting in the F-Domain Measuring Mode	5-3
5.2 Measurement Parameter Settings in Due to Transient, Due to Modulation and Inband Spurious	5-4
5.2.1 Marker Edit Function	5-4
5.2.2 Measurement results Using Due to Modulation, Due to Transient and Inband Spurious Modes	5-5
5.2.3 Measurement Result of Inband Spurious	5-6
5.3 Mag Error (Magnitude Error)	5-7
5.4 Phase Error	5-7
5.5 E.V.M. (Error Vector Magnitude)	5-8
5.6 Waveform Quality	5-9
5.7 About a Code Domain Power coefficient	5-9
5.8 About the Carrier Frequency Error of QPSK	5-9
5.9 Block Diagram	5-10
6 PERFORMANCE VERIFICATION TEST(3GPP)	6-1
6.1 General	6-1
6.1.1 Introduction	6-1
6.1.2 Test Equipment	6-2
6.1.3 Specifications Required for Test Signals	6-3
6.1.4 Calibration Cycle	6-4
6.1.5 Performance Verification Test Record Sheets	6-4
6.1.6 Performance Verification Procedure	6-4
6.2 Performance Verification Test Procedure	6-5
6.2.1 Down Link Measurement in RF Input	6-5
6.2.2 Up Link Measurement in RF Input	6-6
6.2.3 QPSK Measurement in RF Input	6-8

6.2.4	Down Link Measurement in IQ Input	6-10
6.2.5	Up Link Measurement in IQ Input	6-11
6.2.6	QPSK Measurement in IQ Input	6-13
6.2.7	Simplified Performance Check	6-14
6.3	Performance Verification Test Record Sheet	6-16
6.4	Performance Check Record Sheet	6-18
7	SPECIFICATIONS	7-1
	APPENDIX	A-1
A.1	Messages	A-1
	ALPHABETICAL INDEX	I-1

LIST OF ILLUSTRATIONS

No.	Title	Page
2-1	Setup for the measurement of the 3GPP signal	2-1
2-2	3GPP Signal's Spectrum	2-2
2-3	STD-Measurement parameter set Dialog Box	2-2
2-4	Parameter Setup [SLOT/DOWNLINK] Dialog Box	2-3
2-5	Measurement Result of 3GPP Signal	2-5
2-6	Setup for the measurement of the 3GPP signal	2-6
2-7	3GPP Signal's Spectrum	2-6
2-8	Parameter Setup [FRAME/DOWNLINK] Dialog Box	2-7
2-9	Setup for the measurement of the 3GPP signal	2-9
2-10	3GPP Signal's Spectrum	2-10
2-11	Parameter Setup [SLOT/UPLINK] Dialog Box	2-11
2-12	Measurement Result of 3GPP Signal (UPLINK mode)	2-12
2-13	Setup for the measurement of the 3GPP signal	2-13
2-14	3GPP Signal's Spectrum	2-13
2-15	Parameter Setup [FRAME/UPLINK] Dialog Box	2-14
2-16	Graph Display (When Meas Mode Set to SLOT and Link Set to DOWNLINK)	2-16
2-17	Graph Display (When Meas Mode Set to SLOT and Link Set to UPLINK)	2-16
2-18	Graph Display (When Meas Mode Set to FRAME and Link Set to DOWNLINK)	2-17
2-19	Variation over Time in the Code Domain Power Coefficient	2-18
2-20	Constellation	2-18
2-21	Eye Pattern	2-19
2-22	Eye Pattern (Dual Screen Display)	2-20
2-23	Setup for the measurement of the QPSK signal	2-21
2-24	QPSK Signal's Spectrum	2-21
2-25	Parameter Setup Dialog Box	2-22
2-26	QPSK Signal Measurement Result	2-23
2-27	Setup for the measurement of the Power vs Time	2-24
2-28	3GPP Signal Spectrum under Control of Transmission Power	2-25
2-29	Power vs Time Parameter Setup Dialog Box	2-26
2-30	Measurement Result of Power vs Time	2-26
2-31	Setup for the measurement of the Power vs Time	2-27
2-32	3GPP Signal Spectrum under Control of Transmission Power	2-28
2-33	Time & FFT Parameter Setup Dialog Box	2-29
2-34	Power vs Time Parameter Setup Dialog Box	2-30
2-35	Setup for CCDF Measurement	2-31
2-36	3GPP Signal Spectrum under Control of Transmission Power	2-32
2-37	CCDF Parameter Setup Dialog Box	2-32
2-38	CCDF Measurement Result	2-33
2-39	CCDF Measurement Result (Trace Write ON)	2-34
2-40	Setup for Primary CPICH Power Measurement	2-35
2-41	3GPP Signal Spectrum	2-36
2-42	STD Measurement Parameter Set Dialog Box	2-36
2-43	Parameter Setup Dialog Box	2-37
2-44	P-CPICH Power Measurement Results	2-37
3-1	Communication Systems Dialog Box	3-27

List of Illustrations

No.	Title	Page
3-2	Trigger Setup Dialog Box	3-28
3-3	Parameter Setup Dialog Box	3-30
3-4	Trigger Setup Dialog Box	3-31
3-5	Parameter Setup Dialog Box	3-33
3-6	Trigger Setup Dialog Box	3-34
3-7	Parameter Setup Dialog Box	3-35
3-8	Trigger Setup Dialog Box	3-37
3-9	Detector Dialog Box	3-38
3-10	Parameter Setup Dialog Box	3-39
3-11	Parameter Setup Dialog Box	3-41
3-12	Parameter Setup Dialog Box	3-43
3-13	Trigger Setup Dialog Box	3-45
3-14	Detector Dialog Box	3-46
3-15	Parameter Setup Dialog Box	3-47
3-16	Parameter Setup Dialog Box	3-50
3-17	Parameter Setup Dialog Box	3-53
3-18	Parameter Setup Dialog Box	3-56
3-19	Selecting the Unit of the Graph Horizontal Axis (for Channel Number)	3-58
3-20	Selecting the Unit of the Graph Horizontal Axis (for Time)	3-58
3-21	Graph Type of Analysis Dialog Box	3-59
3-22	Graph Type of Analysis Dialog Box	3-60
3-23	3GPP User Channel Setting Dialog Box	3-63
3-24	Parameter Setup [SLOT/DOWNLINK] Dialog Box	3-63
3-25	Explanation Diagram of MEAS Unit	3-66
3-26	Parameter Setup [FRAME/DOWNLINK] Dialog Box	3-67
3-27	Explanation Diagram of MEAS Slots	3-69
3-28	Parameter Setup [SLOT/UPLINK] Dialog Box	3-70
3-29	Explanation Diagram of MEAS Unit	3-72
3-30	Parameter Setup [FRAME/UPLINK] Dialog Box	3-73
3-31	Examination Diagram of Meas Slots	3-74
3-32	Graphic Type of Analysis Dialog Box	3-76
3-33	QPSK Measurement parameter set Dialog Box	3-77
3-34	Limit Setup Dialog Box	3-78
3-35	Parameter Setup Dialog Box	3-79
3-36	Scale Setup Dialog Box	3-80
3-37	Parameter Setup Dialog Box	3-81
3-38	Marker Setup Dialog Box	3-82
3-39	Template Setup Dialog Box	3-83
3-40	Scale Setup Dialog Box	3-83
3-41	Parameter Setup Dialog Box	3-84
3-42	Parameter Setup Dialog Box	3-85
3-43	Select Type Dialog Box	3-86
3-44	Parameter Setup Dialog Box	3-86
3-45	STD Measurement parameter Setup Dialog Box	3-87
5-1	Template to Be Set	5-1
5-2	Template Settings	5-2
5-3	Template Shifted Using the Shift Y Function	5-2

No.	Title	Page
5-4	Template with the Set Values	5-3
5-5	Template with Margin Delta X	5-3
5-6	Example of Marker Edit Setting (1)	5-4
5-7	Example of Marker Edit Setting (2)	5-5
5-8	Example of Peak Marker Y Delta	5-5
5-9	Mag Error, Phase Error, E.V.M.	5-8
5-10	Block Diagram	5-10
6-1	Timing Chart	6-3
6-2	Setup of Down Link Measurement (RF Input)	6-5
6-3	Setting of Measurement Parameters for Down Link (RF Input)	6-6
6-4	Setup of Up Link Measurement (RF Input)	6-7
6-5	Setting of Measurement Parameters for Up Link (RF Input)	6-8
6-6	Setup of QPSK Measurement (RF Input)	6-9
6-7	Setting of Measurement Parameters for QPSK (RF Input)	6-9
6-8	Setup of Down Link Measurement (IQ Input)	6-10
6-9	Setting of Measurement Parameters for Down Link (IQ Input)	6-11
6-10	Setup of Up Link Measurement (IQ Input)	6-12
6-11	Setting of Measurement Parameters for Up Link (IQ Input)	6-12
6-12	Setup of QPSK Measurement (IQ Input)	6-13
6-13	Setting of Measurement Parameters for QPSK (IQ Input)	6-14
6-14	Setup of Simplified Performance Check	6-15
6-15	Setting of Measurement Parameters for QPSK (RF Input)	6-15

LIST OF TABLES

No.	Title	Page
4-1	Operating Mode	4-10
4-2	ATT Key (Attenuator)	4-10
4-3	COPY Key (Hard copy)	4-10
4-4	COUPLE Key (Couple function)	4-11
4-5	FREQ Key (Frequency)	4-11
4-6	LEVEL Key (Reference Level)	4-11
4-7	MKR Key (Marker)	4-12
4-8	PRESET Key (Initialization)	4-12
4-9	RCL Key (Recall)	4-12
4-10	SAVE Key (Save)	4-13
4-11	SPAN Key (Frequency span)	4-13
4-12	TRANSIENT Key	4-14
4-13	Numeric Keys/Step Keys/Data Knob/Unit Keys (Entering Data)	4-63
4-14	Miscellaneous	4-64
6-1	Performance Verification Items	6-1
6-2	Equipment List	6-2
6-3	Specifications Required for Test Signals	6-3

1 INTRODUCTION

1.1 Product Overview

This 3GPP analysis option software allows you to measure the waveform quality and resolution accuracy of a 3GPP signal.

This option is a factory option which is incorporated into the R3267 Series Spectrum Analyzer prior to shipment.

This option includes the following features:

- Can measure the modulation accuracy, waveform quality, frequency error, and magnitude error of the base station (BS) and mobile station (UE) signals.
- Can measure the code domain power of the BS and UE signals.
- Can be used to measure OBW or ACP due to Transient specified by the communication standard with a simple key operation.

1.2 Accessories

Name of accessories	Type of name	Quantity	Remarks
R3267 Series OPT62 Operation manual	ER3267/73OPT62-3GPP	1	English

1.3 Self Test Function

The self test also checks the Option 62 for correct operation when the spectrum analyzer power is turned on. The message shown below will be displayed when an error related to Option 62 occurs. Contact ADVANTEST Corp. for repair.

Error Message
Handshake error occurred to DSP

1.4 About Calibration

When you want to calibrate the R3267 Series, please contact a sales representative.

Desirable Period	One year
------------------	----------

1.5 Explanation of the Connectors

Connectors used for this option are described as follows:

1. EXT TRIG terminal Connector for inputting the external trigger signal.
2. I channel terminal Connector for inputting the I channel signal (Baseband).
3. Q channel terminal Connector for inputting the Q channel signal (Baseband).

2 MEASUREMENT EXAMPLES

This chapter describes how to use this option using practical measurement examples.

2.1 Measuring the BTS 3GPP Signals

By measuring the BS signals in 3GPP mode, it is possible to measure code domain powers for the Primary CPICH, Primary CCPCH, SCH and speech channels separately.

Measurement conditions:

The signal to be measured is as follows:

the output signal of a unit to be measured in the 3GPP mode with a frequency of 2112.5 MHz and a level of -10 dBm.

Signal specifications are as follows:

Scrambling code number 0

Channel	Spreading Factor	Code Number
Primary CPICH	256 (15 ksps)	0
Primary CCPCH	256 (15 ksps)	1
SCH	256 (15 ksps)	-
Channel 1	128 (30 ksps)	2
Channel 2	128 (30 ksps)	3
Channel 3	128 (30 ksps)	4

2.1.1 Measuring the Slot

Setup

1. Connect the unit under test as shown in Figure 2-1.

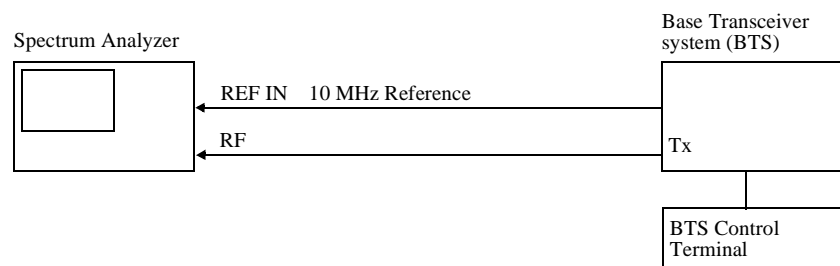

Figure 2-1 Setup for the measurement of the 3GPP signal

2.1 Measuring the BTS 3GPP Signals

Setting the measurement conditions

This changes the analyzer setting so that the input signal displayed more clearly.

2. Press **FREQ, 2, 1, 1, 2, ,, 5** and **MHz**.
3. Press **SPAN, 8** and **MHz**.
4. Press **COUPLE, RBW AUTO/MNL(MNL), 3, 0** and **kHz**.
5. Press **VBW AUTO/MNL(MNL), 3, 0, 0** and **kHz**.
6. Press **LEVEL, 0** and **GHz(+dBm)**.

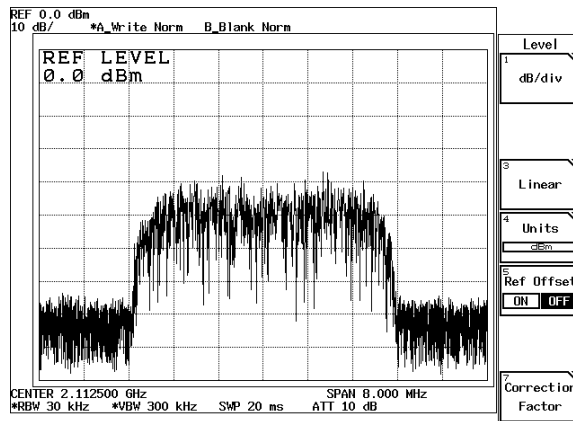

Figure 2-2 3GPP Signal's Spectrum

7. Press **TRANSIENT, STD** and **STD Setup**.
The STD Measurement Parameter Set dialog box is displayed.

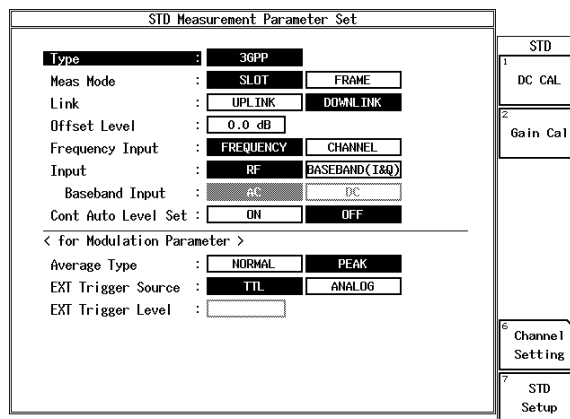

Figure 2-3 STD-Measurement parameter set Dialog Box

8. Press the ∇ key.
The cursor moves to the item Meas Mode.
9. Select **SLOT** from *Meas Mode* using the data knob, and press **Hz(ENTR)**.
The measurement mode is set to SLOT.
10. Select **DOWNLINK** from *Link* using the data knob, and press **Hz(ENTR)**.
The measurement mode is set to the BTS measurement.

The following parameters are default settings.

Offset Level: 0.0 dB
 Frequency Input: FREQUENCY
 Input: RF
 Cont Auto Level Set: OFF
 Average Type: PEAK
 EXT Trigger Source: TTL

11. Press **RETURN**, *Modulation*, *3GPP* and *Parameter Setup*.
The Parameter Setup [SLOT/DOWNLINK] dialog box is displayed.

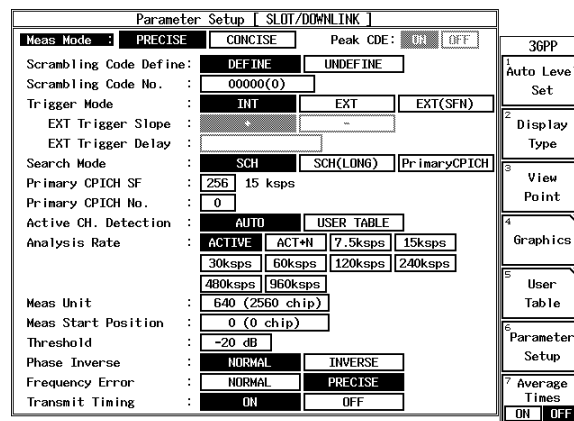

Figure 2-4 Parameter Setup [SLOT/DOWNLINK] Dialog Box

12. Select **PRECISE** from *Meas Mode* using the data knob, and press **Hz(ENTR)**.
The detailed measurement mode is set.
13. Select **DEFINE** from *Scrambling Code Define* using the data knob, and press **Hz(ENTR)**.
A Scrambling code number becomes active.
14. Press **0** and **Hz(ENTR)** to set *Scrambling Code No.*
The Scrambling code No. is set to 0.

2.1 Measuring the BTS 3GPP Signals

15. Select **INT** from **Trigger Mode** using the data knob, and press **Hz(ENTR)**.
The trigger is set to the internal trigger.
16. Select **SCH** from **Search Mode** using the data knob, and press **Hz(ENTR)**.
A synchronization mode using a SCH is set.
17. Enter **256** for **Primary CPICH SF** using the data knob, and press **Hz(ENTR)**.
The spreading factor of the Primary CPICH is set to 256 (the rate is set to 15 ksp/s).
18. Enter **0** for **Primary CPICH No.** using the data knob, and press **Hz(ENTR)**.
The code number of the Primary CPICH is set to 0.
19. Select **Auto** from **Active CH. Detection** using the data knob, and press **Hz(ENTR)**.
The automatic rate judgement mode is set.
20. Select **ACTIVE** from **Analysis Rate** using the data knob, and press **Hz(ENTR)**.
The rates of the channels currently transmitting data are set for measurement.
21. Enter **640 (2560 chips)** for **Meas Unit** using the data knob, and press **Hz(ENTR)**.
The measurement with the range of 640 (2560 chips:1 slot) is set.
22. Enter **0** for **Meas Start Position** using the data knob, and press **Hz(ENTR)**.
The measurement start position is set to the head of the slot (0 chip).
23. Press **-, 2, 0** and **GHz(dB)** to set the **threshold**.
The threshold value of an active channel is set to -20 dB.
24. Select **NORMAL** from **Phase Inverse** using the data knob, and press **Hz(ENTR)**.
The IQ phase is set to a normal phase.
25. Select **PRECISE** from **Frequency Error** using the data knob, and press **Hz(ENTR)**.
The carrier frequency Error Precise Measurement mode is set.
26. Select **ON** from **Transmit Timing** using the data knob, and press **Hz(ENTR)**.
27. Press **Parameter Setup**.
The dialog box is closed.
28. Press **Auto Level Set**.
The measurement range is set to the optimum range.
29. Press **SINGLE**.
The sweep is set to a single mode and starts.

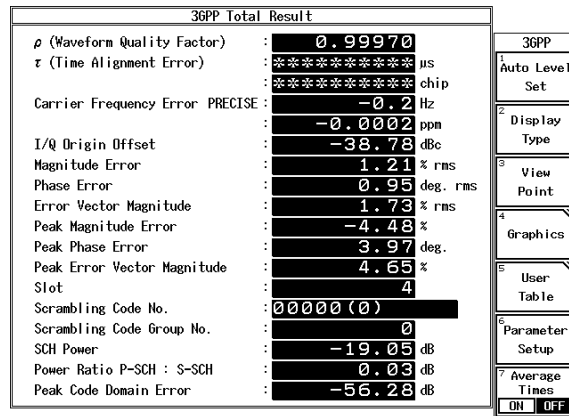

Figure 2-5 Measurement Result of 3GPP Signal

ρ (Waveform Quality Factor): The waveform quality of the signal to be measured. The maximum measurement length is 2560 chips.

τ (Time Alignment Error): A delay time (μ s or chip)

NOTE: When the Trigger Mode is set to INT, the τ (Time Alignment Error) cannot be measured.

Carrier Frequency Error:	A carrier frequency error (Hz, ppm)
I/Q Origin Offset:	An I or Q origin offset (dBc)
Magnitude Error:	A magnitude error (% rms)
Phase Error:	A phase error (deg.rms)
Error Vector Magnitude:	A modulation accuracy (% rms)
Peak Magnitude Error:	Maximum magnitude error (%)
Peak Phase Error:	Maximum phase error (%)
Peak Error Vector Magnitude:	Maximum modulation accuracy (%)
Slot:	A measurement slot number
Scrambling Code No.:	A Scrambling code number
Scrambling Code Group No.:	A Scrambling code group number
SCH Power:	SCH power (dB)
Power Ratio P-SCH:S-SCH:	Power ratio of P-SCH to S-SCH (dB)
Peak Code Domain Error:	Maximum code domain error (dB)

2.1 Measuring the BTS 3GPP Signals

2.1.2 Measuring the Frame

Setup

1. Connect the unit under test as shown in Figure 2-6.

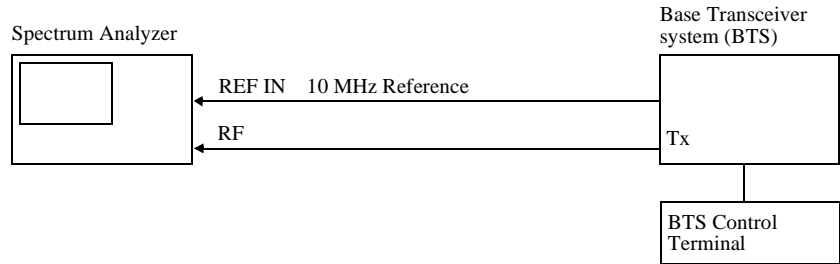

Figure 2-6 Setup for the measurement of the 3GPP signal

Setting the measurement conditions

This changes the analyzer setting so that the input signal displayed more clearly.

2. Press **FREQ, 2, 1, 1, 2, ., 5** and **MHz**.
3. Press **SPAN, 8** and **MHz**.
4. Press **COUPLE, RBW AUTO/MNL(MNL), 3, 0** and **kHz**.
5. Press **VBW AUTO/MNL(MNL), 3, 0, 0** and **kHz**.
6. Press **LEVEL, 0** and **GHz(+dBm)**.

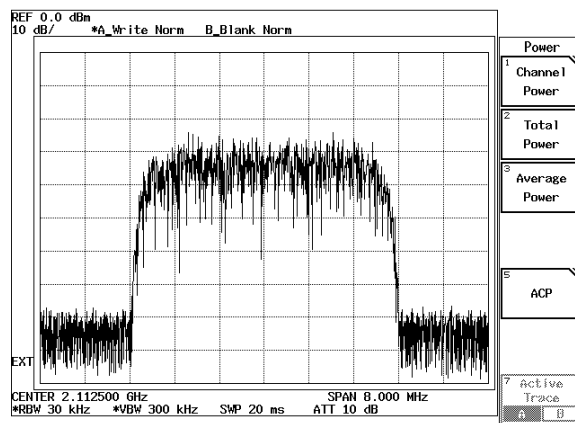

Figure 2-7 3GPP Signal's Spectrum

7. Press **TRANSIENT, STD** and **STD Setup**.
The STD Measurement Set dialog box is displayed.

8. Press the ∇ key.
The cursor moves to the item Meas Mode.
9. Select **FRAME** from **Meas Mode** using the data knob, and press **HZ(ENTR)**.
The measurement mode is set to FRAME.
10. Select **DOWNLINK** from **Link** using the data knob, and press **HZ(ENTR)**.
The measurement mode is set to the BTS measurement.

The following parameters are default settings.

Offset Level: 0.0 dB
 Frequency Input: FREQUENCY
 Input: RF
 Cont Auto Level Set: OFF
 Average Type: PEAK
 EXT Trigger Source: TTL

11. Press **RETURN**, **Modulation**, **3GPP** and **Parameter Setup**.
The Parameter Setup [FRAME/DOWNLINK] dialog box is displayed.

Figure 2-8 Parameter Setup [FRAME/DOWNLINK] Dialog Box

12. Select **DEFINE** from **Scrambling Code Define** using the data knob, and press **HZ(ENTR)**.
A Scrambling code number becomes active.
13. Press **0** and **HZ(ENTR)** to set **Scrambling Code No.**
The Scrambling code No. is set to 0.
14. Select **INT** from **Trigger Mode** using the data knob, and press **HZ(ENTR)**.
The trigger is set to the internal trigger.

2.1 Measuring the BTS 3GPP Signals

15. Select **SCH** from **Search Mode** using the data knob, and press **Hz(ENTR)**.
A synchronization mode using a SCH is set.
16. Enter **256** for **Primary CPICH SF** using the data knob, and press **Hz(ENTR)**.
The spreading factor of the Primary CPICH is set to 256 (the rate is set to 15 ksp/s).
17. Enter **0** for **Primary CPICH No.** using the data knob, and press **Hz(ENTR)**.
The code number of the Primary CPICH is set to 0.
18. Select **Auto** from **Active CH. Detection** using the data knob, and press **Hz(ENTR)**.
The automatic rate judgment mode is set.
19. Enter **128** for **Meas Channel SF** using the data knob, and press **Hz(ENTR)**.
The spreading factor of the channel under measurement is set to 128 (the rate is set to 30 ksp/s).
20. Enter **4** for **Meas Channel No.** using the data knob, and press **Hz(ENTR)**.
The code number of the channel under measurement is set to 4.
21. Enter **15** for **Meas Slots** using the data knob, and press **Hz(ENTR)**.
The measurement range is set to 15 slot.
22. Enter **0** for **Meas Start Position** using the data knob, and press **Hz(ENTR)**.
The measurement start position is set to the head of the slot(0 chip).
23. Press **-, 2, 0** and **GHz(dB)** to set the **threshold**.
The threshold value of an active channel is set to -20 dB.
24. Select **NORMAL** from **Phase Inverse** using the data knob, and press **Hz(ENTR)**.
The IQ phase is set to a normal phase.
25. Press **Parameter Setup**.
The dialog box is closed.
26. Press **Auto Level Set**.
The measurement range is set to the optimum range.
27. Press **SINGLE**.
The sweep is set to a single mode and starts.

2.2 Measuring the MS 3GPP Signal

The waveform quality of the mobile unit can be measured.

Measurement conditions:

The signal to be measured is as follows: the output signal of a unit to be measured in the 3GPP mode with a frequency of 1922.5 MHz and a level of -10 dBm.

Signal specifications are as follows:

Scrambling Code Number 1

Channel	Spreading Factor	Code number	I or Q
DPDCH	64 (60 ksps)	16	I
DPCCH	256 (15ksps)	0	Q

2.2.1 Measuring the Slot

Setup

1. Connect the unit under test as shown in Figure 2-9.

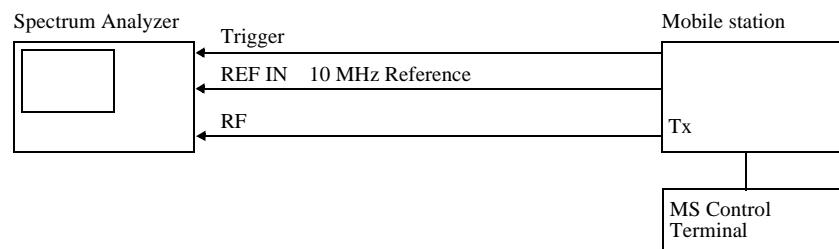

Figure 2-9 Setup for the measurement of the 3GPP signal

Setting the measurement conditions

This changes the analyzer setting so that the input signal displayed more clearly.

2. Press **FREQ, 1, 9, 2, 2, ., 5** and **MHz**.
3. Press **SPAN, 8** and **MHz**.
4. Press **COUPLE, RBW AUTO/MNL(MNL), 3, 0,** and **kHz**.
5. Press **VBW AUTO/MNL(MNL), 3, 0, 0** and **kHz**.

2.2 Measuring the MS 3GPP Signal

6. Press **LEVEL, 0** and **GHz(+dBm)**.

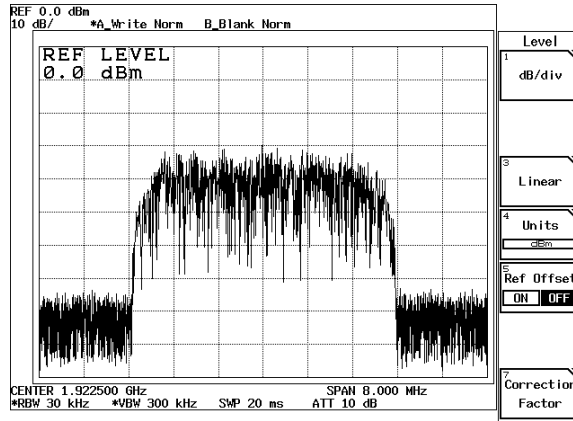

Figure 2-10 3GPP Signal's Spectrum

7. Press **TRANSIENT, STD** and **STD Setup**.
The STD Measurement parameter set dialog box is displayed.
8. Press the ∇ key.
The cursor moves to the item Meas Mode.
9. Select **SLOT** from **Meas Mode** using the data knob, and press **Hz(ENTR)**.
The measurement mode is set to SLOT.
10. Select **UPLINK** from **Link** using the data knob, and press **Hz(ENTR)**.
The measurement mode is set to the mobile unit signal measurement.

The following parameters are default settings.

Offset Level:	0.0 dB
Frequency Input:	FREQUENCY
Input:	RF
Cont Auto Level Set:	OFF
Average Type:	PEAK
EXT Trigger Source:	TTL

11. Press **RETURN, Modulation, 3GPP** and **Parameter Setup**.
The Parameter Setup [SLOT/UPLINK] dialog box is displayed.

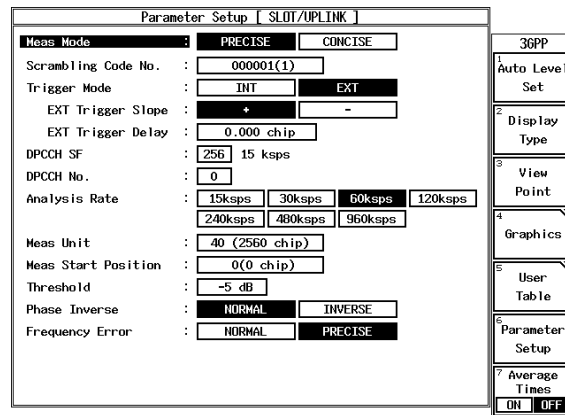

Figure 2-11 Parameter Setup [SLOT/UPLINK] Dialog Box

12. Select **PRECISE** from **Meas Mode** using the data knob, and press **Hz(ENTR)**.
The detailed measurement mode is set.
13. Press **1** and **Hz(ENTR)** to set **Scrambling Code No.**
The Scrambling Code No. is set to 1.
14. Select **EXT** from **Trigger Mode** using the data knob, and press **Hz(ENTR)**.
The measurement mode using the external BS standard reset signal as a trigger signal is set.
15. Select **+** from **EXT Trigger Slope** using the data knob, and press **Hz(ENTR)**.
The trigger slope is set to a trailing edge.
16. Press **0**, **,**, **0** and **Hz(ENTR)** to set **EXT Trigger Delay**.
The trigger delay is set to 0 chip.
17. Enter **256** for **DPCCH SF** using the data knob, and press **Hz(ENTR)**.
The spreading factor of the DPCCH is set to 256.
18. Enter **0** for **DPCCH No.** using the data knob, and press **Hz(ENTR)**.
The code number of the DPCCH is set to 0.
19. Select **60 kbps** for **Analysis Rate** using the data knob, and press **Hz(ENTR)**.
The instrument is set to measure a signal with a rate of 60 kbps.
20. Enter **40 (2560 chips)** for **Meas Unit** using the data knob, and press **Hz(ENTR)**.
The measurement with the range of 40 symbols (2560 chips: 1 slot) is set.

2.2 Measuring the MS 3GPP Signal

21. Press **-**, **5** and **GHz(dB)** to set the *Threshold*.
The threshold value of an active channel is set to -5 dB.
22. Select *NORMAL* from *Phase Inverse* using the data knob, and press **Hz(ENTR)**.
The IQ phase is set to a normal phase.
23. Select *PRECISE* from *Frequency Error* using the data knob, and press **Hz(ENTR)**.
The carrier frequency error precise measurement mode is set.
24. Press *Parameter Setup*.
The dialog box is closed.
25. Press *Auto Level Set*.
The measurement range is set to the optimum range.
26. Press **SINGLE**.
The sweep is set to a single mode and starts.

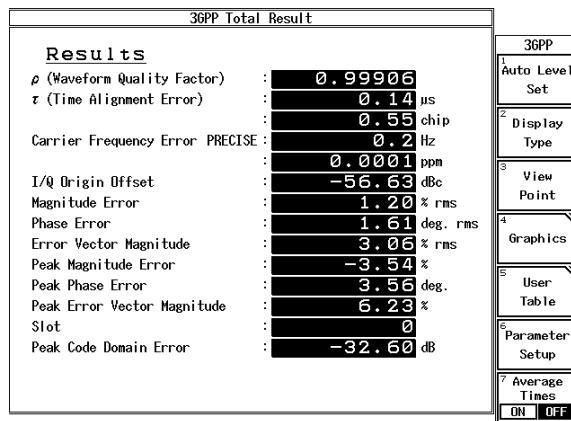

Figure 2-12 Measurement Result of 3GPP Signal (UPLINK mode)

- ρ (Waveform Quality Factor): The waveform quality of the signal to be measured. The maximum measurement length is 2560 chips.
- τ (Time Alignment Error): A delay time (μ s or chip)
- Carrier Frequency Error: A carrier frequency error (Hz, ppm)
- I/Q Origin Offset: An I or Q origin offset (dBc)
- Magnitude Error: A magnitude error (% rms)
- Phase Error: A phase error (deg.rms)
- Error Vector Magnitude: A modulation accuracy (% rms)
- Peak Magnitude Error: Maximum magnitude error (%)
- Peak Phase Error: Maximum phase error (%)
- Peak Error Vector Magnitude: Maximum modulation accuracy (%)
- Slot: Measurement slot number
- Peak Code Domain Error: Maximum code domain error (dB)

2.2.2 Measuring of the Frame

Setup

1. Connect the unit under test as shown in Figure 2-13.

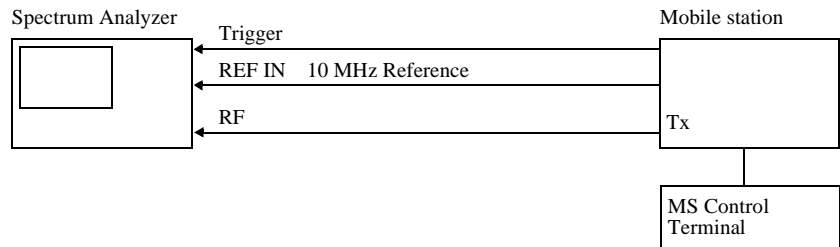

Figure 2-13 Setup for the measurement of the 3GPP signal

Setting the measurement conditions

This changes the analyzer setting so that the input signal displayed more clearly.

2. Press **FREQ, 1, 9, 2, 2, ,, 5** and **MHz**.
3. Press **SPAN, 8** and **MHz**.
4. Press **COUPLE, RBW AUTO/MNL(MNL), 3, 0** and **kHz**.
The RBW is set to 30 kHz.
5. Press **VBW AUTO/MNL(MNL), 3, 0, 0** and **kHz**.
The VBW is set to 300 kHz.
6. Press **LEVEL, 0** and **GHz(+dBm)**.

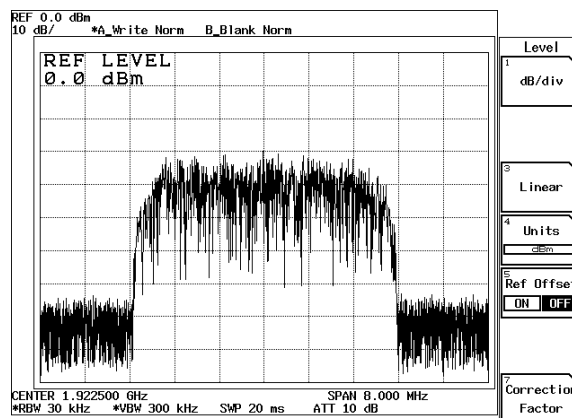

Figure 2-14 3GPP Signal's Spectrum

2.2 Measuring the MS 3GPP Signal

7. Press **TRANSIENT**, **STD** and **STD Setup**.
The STD Measurement parameter set dialog box is displayed.
8. Press the ∇ key.
The cursor moves to the item Meas Mode.
9. Select **FRAME** from **Meas Mode** using the data knob, and press **Hz(ENTR)**.
The measurement mode is set to FRAME.
10. Select **UPLINK** from **Link** using the data knob, and press **Hz(ENTR)**.
The measurement mode is set to the mobile unit signal measurement.

The following parameters are default settings.

Offset Level: 0.0 dB
 Frequency Input: FREQUENCY
 Input: RF
 Cont Auto Level Set: OFF
 Average Type: PEAK
 EXT Trigger Source: TTL

11. Press **RETURN**, **Modulation**, **3GPP** and **Parameter Setup**.
The Parameter Setup [FRAME/UPLINK] dialog box is displayed.

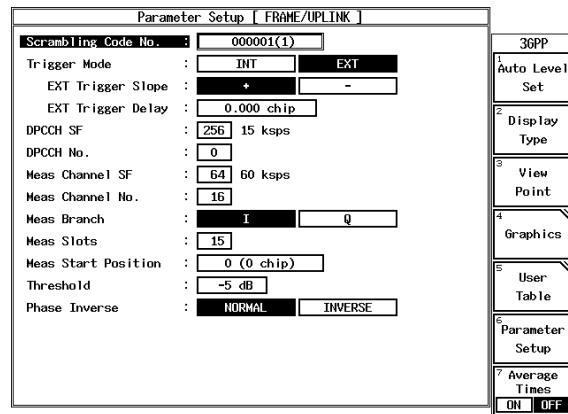

Figure 2-15 Parameter Setup [FRAME/UPLINK] Dialog Box

12. Press **1** and **Hz(ENTR)** to set **Scrambling Code No.**.
The Scrambling code No. is set to 1.
13. Select **EXT** from **Trigger Mode** using the data knob, and press **Hz(ENTR)**.
The measurement mode using the external BS standard reset signal as a trigger signal is set.

14. Select **+** from *EXT Trigger Slope* using the data knob, and press **Hz(ENTR)**.
The trigger slope is set to a leading edge.
15. Enter **0,.,0** for *EXT Trigger Delay* using the data knob, and press **Hz(ENTR)**.
The trigger delay is set to 0 chip.
16. Enter **256** for *DPCCH SF* using the data knob, and press **Hz(ENTR)**.
The spreading factor of the DPCCH is set to 256.
17. Enter **0** for *DPCCH No.* using the data knob, and press **Hz(ENTR)**.
The code number of the DPCCH is set to 0.
18. Enter **64** for *Meas Channel SF* using the data knob, and press **Hz(ENTR)**.
The spreading factor of the channel under measurement is set to 64.
19. Enter **16** for *Meas Channel No.* using the data knob, and press **Hz(ENTR)**.
The code number of the channel under measurement is set to 16.
20. Select **I** from *Meas Branch* using the data knob, and press **Hz(ENTR)**.
The branch of the channel under measurement is set to I.
21. Enter **15** for *Meas Slots* using the data knob, and press **Hz(ENTR)**.
The measurement with the range of 15 is set.
22. Enter **0** for *Meas Start Position* using the data knob, and press **Hz(ENTR)**.
The measurement start position is set to the head of a slot (0 chip).
23. Press **-,5** and **GHz(dB)** to set the *Threshold*.
The threshold value of an active channel is set to -5 dB.
24. Select **NORMAL** from *Phase Inverse* using the data knob, and press **Hz(ENTR)**.
The IQ phase is set to a normal phase.
25. Press **Parameter Setup**.
The dialog box is closed.
26. Press **Auto Level Set**.
The measurement range is set to the optimum range.
27. Press **SINGLE**.
The sweep is set to a single mode and starts.

2.3 Graphical Display of 3GPP Measurements

2.3 Graphical Display of 3GPP Measurements

The resultant graphs can be displayed. This chapter describes how to display the graphs.

Displaying a Graph for the Code Domain Power Coefficient

1. Press *Display Type*.
The Display Type dialog box is displayed.
2. Select **GRAPH** from *Format* using the data knob, and press **HZ(ENTR)**.
The Graphic Type of Analysis dialog box is displayed.
3. Select **ρ** from *Y Scale* using the data knob, and press **HZ(ENTR)**.
The vertical axis is set to the code domain power coefficient.
4. Press *Display Type*.
The dialog box is closed. Code domain power coefficient is displayed.

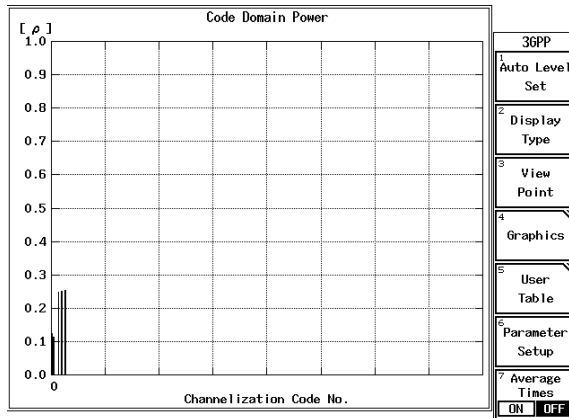

Figure 2-16 Graph Display (When Meas Mode Set to SLOT and Link Set to DOWNLINK)

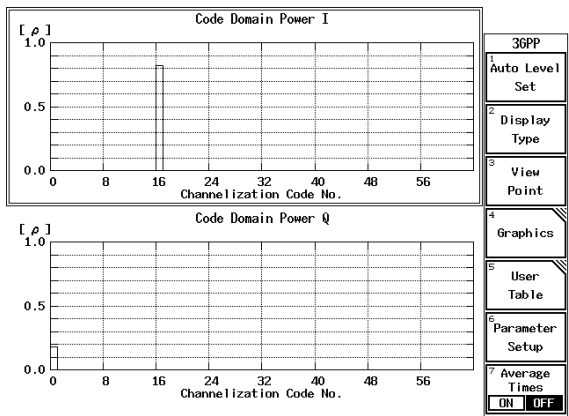

Figure 2-17 Graph Display (When Meas Mode Set to SLOT and Link Set to UPLINK)

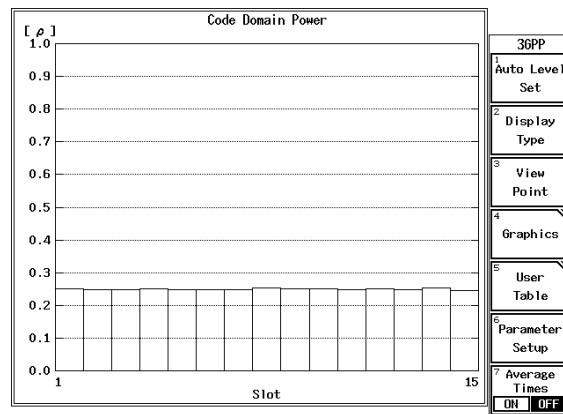

Figure 2-18 Graph Display (When Meas Mode Set to FRAME and Link Set to DOWNLINK)

Measuring the Code Domain Power Coefficients for Each Symbol
(When Link Set to DOWNLINK and Rate Set to 15 ksp/s)

5. Press **Parameter Setup**.
The Parameter Setup [SLOT/DOWNLINK] dialog box is displayed.
6. Enter **64 (256 chips)** for **Meas Unit** using the data knob, and press **Hz(ENTR)**.
The measurement with the range of 1 symbols (256 chips) is set.
7. Press **Parameter Setup**.
The dialog box is closed.
8. Press **SINGLE**.
The measurement mode is set to Single and the measured result is displayed.
9. Press **View Point**.
The screen for setting Short Code No. in a time-axis direction is displayed.
10. Select a value using the data knob.
The power of each Short Code No. in an arbitrary time-axis is displayed.

Displaying Variation over Time in the Code Domain Power Coefficient in the Primary CCPCH.

11. Press **Display type**.
The Display Type dialog box is displayed.
12. Select **TIME** from **X Scale** using the data knob, and press **Hz(ENTR)**.
Time Code Domain Power is displayed.
13. Press **1** and **Hz(ENTR)** to set **View Point**.
The power of Primary CCPCH (code number 1) is set for the measurement.

2.3 Graphical Display of 3GPP Measurements

14. Press **View Point**.

The Display Type dialog box disappears and the code domain power coefficient is displayed in the time domain.

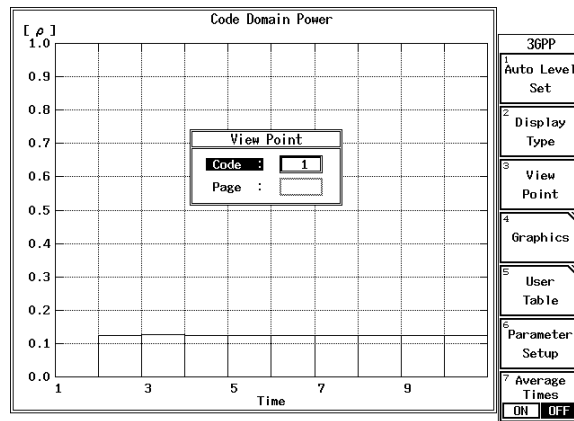

Figure 2-19 Variation over Time in the Code Domain Power Coefficient

Displaying a Graph for a Constellation

15. Press **Graphics**.
The Graphic menu is displayed.
16. Press **Select type**.
The Graphic Type of Analysis dialog box is displayed.
17. Select **Constellation** using the data knob, and press **Hz(ENTR)**.
The constellation screen is displayed.

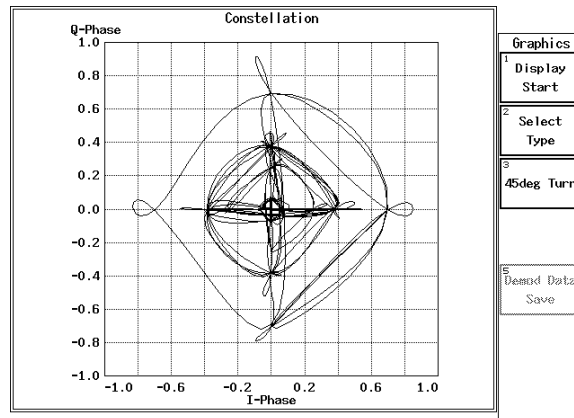

Figure 2-20 Constellation

Displaying the I channel Eye Diagram

18. Press **Graphics**.
The graphic menu is displayed.
19. Press **Select type**.
The Graphic Type of Analysis dialog box is displayed.
20. Select **I EYE Diagram** using the data knob, and press **Hz(ENTR)**.
The eye diagram of I channel is displayed.

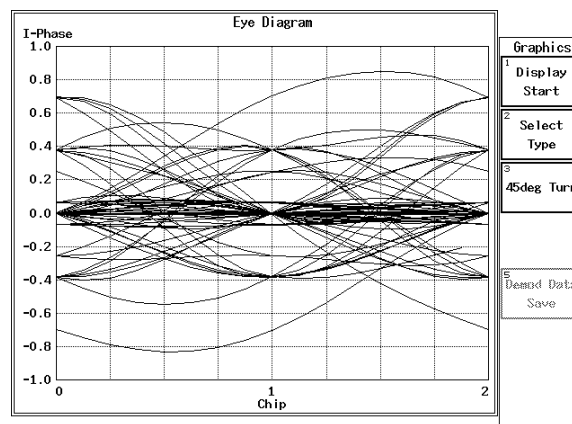

Figure 2-21 Eye Pattern

Displaying Diagrams of I channel and Q channel

21. Press **Graphics**.
The Graphic menu is displayed.
22. Press **Select type**.
The Graphic Type of Analysis dialog box is displayed.
23. Select **I/Q EYE Diagram** using the data knob, and press **Hz(ENTR)**.
The eye diagrams of Ich and Qch are displayed.

2.3 Graphical Display of 3GPP Measurements

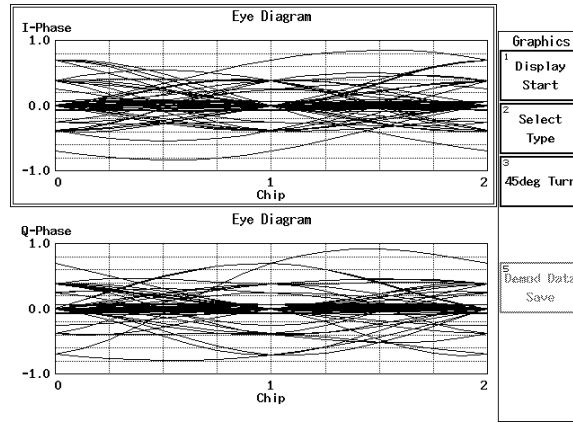

Figure 2-22 Eye Pattern (Dual Screen Display)

2.4 Measuring a QPSK Signal

Use the Root Nyquist filter to measure the QPSK for a measurement length of 320 chips, beginning with the 256.25th chip from the leading edge of the external trigger signal.

Setup

1. Connect the unit under test as shown in Figure 2-23.

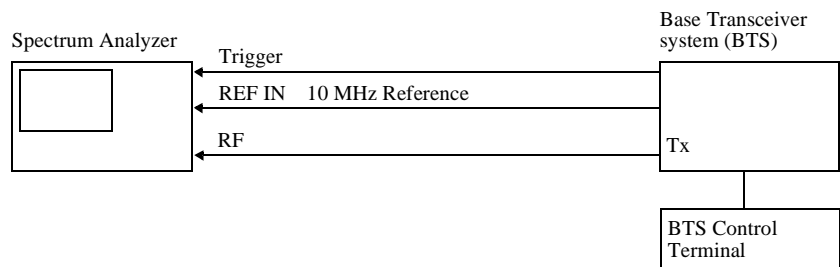

Figure 2-23 Setup for the measurement of the QPSK signal

Setting the measurement conditions

This changes the analyzer setting so that the input signal displayed more clearly.

2. Press **FREQ, 1, 9, 2, 2, ,, 5** and **MHz**.
3. Press **SPAN, 8** and **MHz**.
4. Press **COUPLE, RBW AUTO/MNL(MNL), 3, 0** and **kHz**.
5. Press **VBW AUTO/MNL(MNL), 3, 0, 0** and **kHz**.
6. Press **LEVEL, 0** and **GHz(+dBm)**.

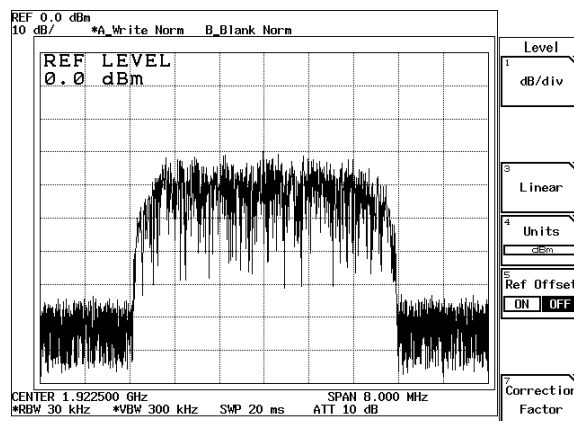

Figure 2-24 QPSK Signal's Spectrum

2.4 Measuring a QPSK Signal

7. Press **TRANSIENT**, **STD** and **STD Setup**.
The STD Measurement parameter set dialog box is displayed.
8. Select **RF** from **Input** using the data knob, and press **Hz(ENTR)**.
The measurement mode is set to the RF signal input.

The following parameters are default settings.

Link:	DOWNLINK
Offset Level:	0.0dB
Frequency Input:	FREQUENCY
Cont Auto Level Set:	OFF
Average Type:	PEAK
EXT Trigger Source:	TTL

NOTE: It is unnecessary to set Meas Mode.

9. Press **RETURN**, **Modulation**, **QPSK** and **Parameter Setup**.
The Parameter Setup dialog box is displayed.

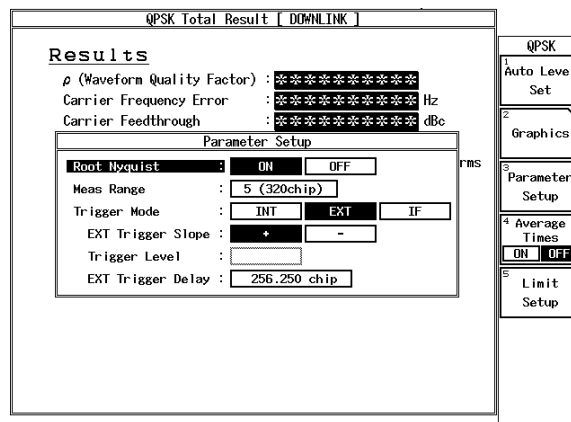

Figure 2-25 Parameter Setup Dialog Box

10. Select **ON** from **Root Nyquist** using the data knob, and press **Hz(ENTR)**.
The root Nyquist filter becomes active.
11. Press **5** and **Hz(ENTR)** to set **Meas Range**.
The Meas Range is set to 5 (320 chips).
12. Select **EXT** from **Trigger Mode** using the data knob, and press **Hz(ENTR)**.
The measurement mode using an external trigger signal is set.

13. Select + from *EXT Trigger Slope* using the data knob, and press **Hz(ENTR)**.
The trigger slope is set to a leading edge.
14. Press **2, 5, 6, ,, 2, 5** and **Hz(ENTR)** to set *EXT Trigger Delay*.
The trigger delay is set to 256.25 chips.
15. Press *Parameter Setup*.
The dialog box is closed.
16. Press *Auto Level Set*.
The measurement range is set to the optimum range.
17. Press **SINGLE**.
The sweep is set to a the single mode and starts.

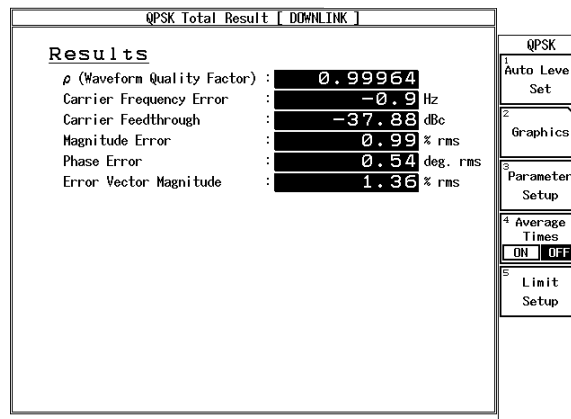

Figure 2-26 QPSK Signal Measurement Result

- ρ (Waveform Quality Factor): The waveform quality of the signal to be measured.
- Carrier Frequency Error: A carrier frequency error (Hz)
- Carrier Feedthrough: An I or Q origin offset (dBc)
- Magnitude Error: A magnitude error (% rms)
- Phase Error: A phase error (deg. rms)
- Error Vector Magnitude: A modulation accuracy (% rms)

2.5 Power vs Time

2.5 Power vs Time

The power can be measured for each slot (666.66µs).

Measurement conditions:

The signal is the output signal from a 3GPP type unit and has the following characteristics: a frequency of 1922.5 MHz and a level between -20 dBm and -10 dBm under control of transmission power.

Signal specifications are as follows:

Scrambling code number 1

Channel	Spreading Factor	Code Number	I or Q
DPDCH	64 (60 ksps)	16	I
DPCCH	256 (15 ksps)	0	Q

2.5.1 Measuring Power Variations Using the External Trigger

Setup

1. Connect the unit under test as shown in Figure 2-27.

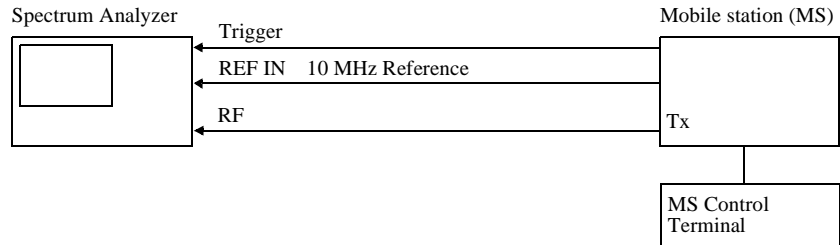

Figure 2-27 Setup for the measurement of the Power vs Time

Setting the measurement conditions

This changes the analyzer setting so that the input signal may be displayed more clearly.

2. Press **FREQ, 1, 9, 2, 2, ,, 5** and **MHz**.
A center frequency of 1922.5 MHz is set.
3. Press **SPAN, 8** and **MHz**.
A frequency span of 8 MHz is set.
4. Press **COUPLE, RBW AUTO/MNL(MNL), 3, 0** and **kHz**.
An RBW of 30 kHz is set.
5. Press **VBW AUTO/MNL(MNL), 3, 0, 0** and **kHz**.
A VBW of 300 kHz is set.

6. Press **LEVEL, 0** and **GHz(+dBm)**.
The reference level is set to 0 dBm.

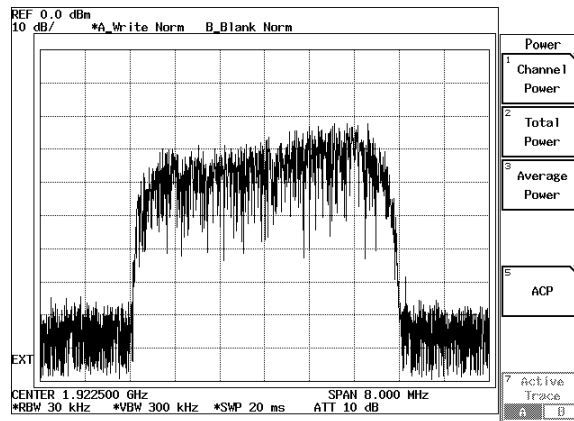

Figure 2-28 3GPP Signal Spectrum under Control of Transmission Power

Measuring Power Variations Using One External Trigger

7. Press **TRANSIENT, Modulation, Power, Power vs Time** and **Parameter Setup**.
The Parameter Setup dialog box is displayed.
8. Set the **Meas Mode** to **PRECISE** using the data knob, and press **Hz(ENTR)**.
The detailed measurement mode is set.
9. Select **OFF** from **Root Nyquist** using the data knob, and press **Hz(ENTR)**.
The Root Nyquist filter is disabled.
10. Select **EXT** from **Trigger Mode** using the data knob, and press **Hz(ENTR)**.
The measurement mode using the external trigger signal is set.
11. Select **+** from **Trigger Slope** using the data knob, and press **Hz(ENTR)**.
The trigger slope is set to a leading edge.
12. Press **0, .,0** and **Hz(ENTR)** to set **Trigger Delay**.
The trigger delay is set to 0 μ s.
13. Press **3, 0** and **Hz(ENTR)** to set **Meas Length**.
The measurement range is set to Slot 30.
14. Select **AVERAGE** from **Graph Plot Type** using the data knob, and press **Hz(ENTR)**.
A graph for the average is displayed.

2.5 Power vs Time

15. Select **OFF** from **Omit Transient Section for AVG Power** using the data knob, and press **Hz(ENTR)**.
The power is measured every 666.66 μ s.

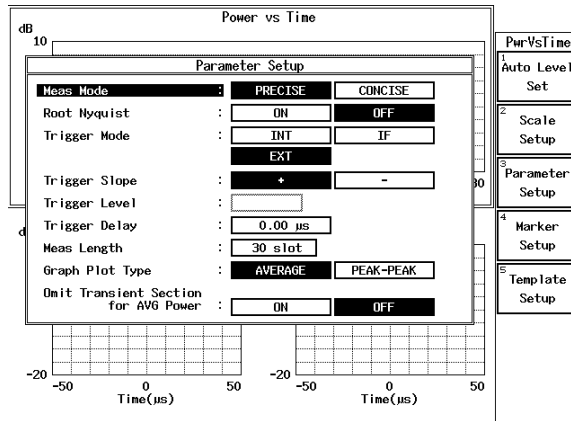

Figure 2-29 Power vs Time Parameter Setup Dialog Box

16. Press **Parameter Setup**.
The dialog box is removed.
17. Press **Auto Level Set**.
The measurement range is optimally set.
18. Press **SINGLE**.
The measurement mode is set to the single mode and the measurement mode is displayed.

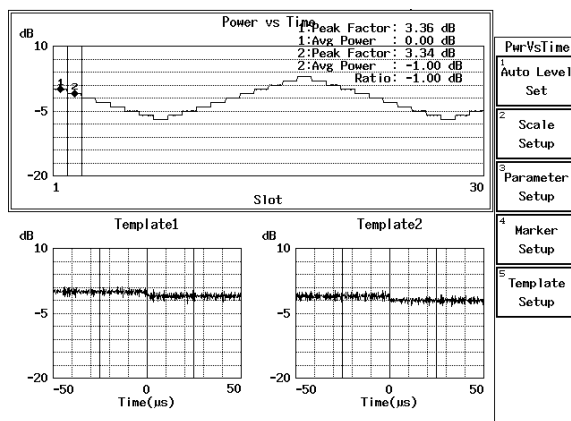

Figure 2-30 Measurement Result of Power vs Time

- | | |
|----------------|---|
| 1: Peak Factor | Peak factor of the slot specified by Power Marker 1 |
| 1: Avg Power | Average power of the slot specified by Power Marker 1 |

2: Peak Factor	Peak factor of the slot specified by Power Marker 2
2: Avg Power	Average power of the slot specified by Power Marker 2
Ratio	(2:Avg Power) - (1:Avg Power)
Upper screen	Graph representing power varies within the measurement range
Lower left screen	Magnified view of the slot boundary ($\pm 50 \mu\text{s}$) specified by Template 1
Lower right screen	Magnified view of the slot boundary ($\pm 50 \mu\text{s}$) specified by Template 2

2.5.2 Measuring Power Variations Using the IF Trigger

Setup

1. Connect the unit under test as shown in Figure 2-31.

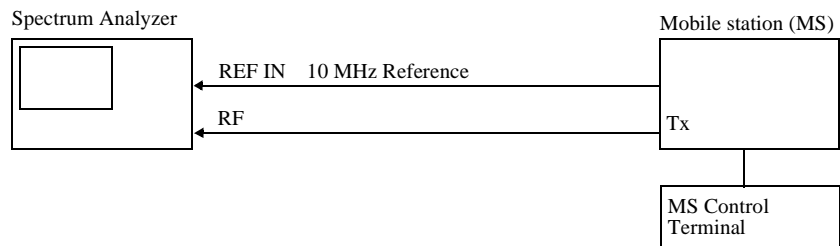

Figure 2-31 Setup for the measurement of the Power vs Time

Setting the measurement conditions

This changes the analyzer setting so that the input signal may be displayed more clearly.

2. Press **FREQ, 1, 9, 2, 2, ., 5** and **MHz**.
A center frequency of 1922.5 MHz is set.
3. Press **SPAN, 8** and **MHz**.
A frequency span of 8 MHz is set.
4. Press **COUPLE, RBW AUTO/MNL(MNL), 3, 0** and **kHz**.
An RBW of 30 kHz is set.
5. Press **VBW AUTO/MNL(MNL), 3, 0, 0** and **kHz**.
A VBW of 300 kHz is set.
6. Press **LEVEL, 0** and **GHz(+dBm)**.
The reference level is set to 0 dBm.

2.5 Power vs Time

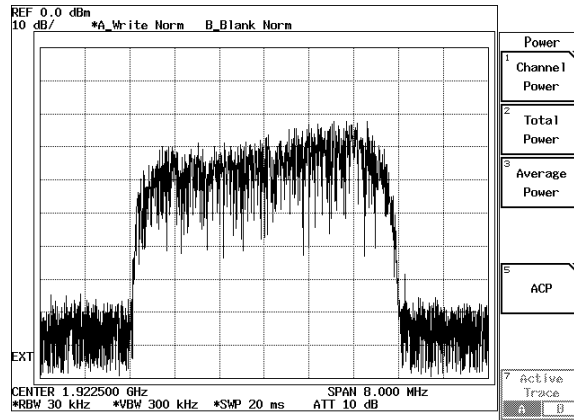

Figure 2-32 3GPP Signal Spectrum under Control of Transmission Power

Measuring Power Variations Using the IF Trigger

7. Press **TRANSIENT**, **Modulation**, **Time & FFT** and **Parameter Setup**.
The parameter Setup dialog box is displayed.
8. Select **IF** from **Trigger Source** using the data knob, and press **Hz(ENTR)**.
The measurement mode using the IF trigger signal is set.
9. Press **1, 0, 0** and **Hz(ENTR)** to set **Trigger Level**.
The trigger level is set to 100%.
10. Press **0, ., 0** and **Hz(ENTR)** to set **Trigger Delay**.
The trigger delay is set to 0 chip.
11. Press **Auto Level Set**.
The measurement range is optimally set.
12. Press **REPEAT**.
The measurement mode is set to the repeat mode, and measurement result is displayed.
13. Lower the **Trigger level** in steps of 1% using the data knob until a continuous trace is displayed (be aware that no errors occur when a continuous trace is obtained, and that time out errors may occur while the trigger level is being lowered).
The trigger has just been set.

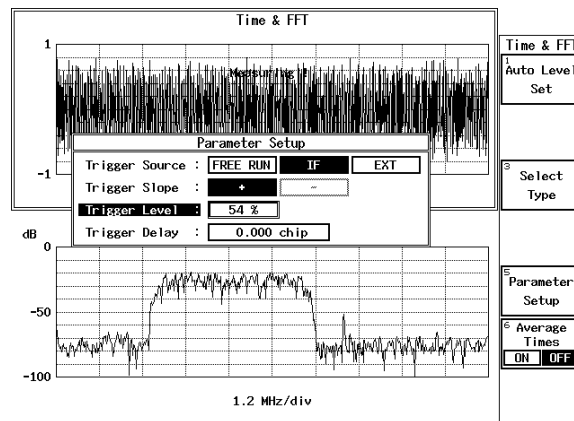

Figure 2-33 Time & FFT Parameter Setup Dialog Box

14. Press **RETURN**, **Power**, **Power vs Time** and **Parameter Setup**.
The Parameter Setup dialog box is displayed.
15. Set the **Meas Mode** to **PRECISE** using the data knob, and press **Hz(ENTR)**.
The detailed measurement mode is set.
16. Select **OFF** from **Root Nyquist** using the data knob, and press **Hz(ENTR)**.
The Root Nyquist filter is disabled.
17. Select **IF** from **Trigger Mode** using the data knob, and press **Hz(ENTR)**.
The measurement mode using the IF trigger signal is set.
18. Set the **Trigger level** to the level obtained for **Time & FFT**, and press **Hz(ENTR)**.
The trigger level is set.
19. Press **0**, **.,0** and **Hz(ENTR)** to set **Trigger Delay**.
The trigger delay is set to 0 μ s.
20. Press **3**, **0** and **Hz(ENTR)** to set **Meas Length**.
The measurement range is set to Slot 30.
21. Select **AVERAGE** from **Graph Plot Type** using the data knob, and press **Hz(ENTR)**.
A graph for the average is displayed.
22. Select **OFF** from **Omit Transient Section for AVG Power** using the data knob, and press **Hz(ENTR)**.
The power is measured every 666.66 μ s.

2.5 Power vs Time

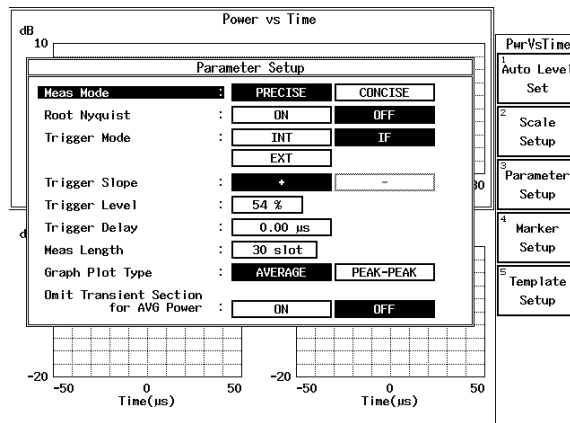

Figure 2-34 Power vs Time Parameter Setup Dialog Box

23. Press **Parameter Setup**.
The dialog box is removed.
24. Press **SINGLE**.
The measurement mode is set to the single mode and the measurement mode is displayed.

2.6 CCDF Measurement

The CCDF (Complementary Cumulative Distribution Function) can be measured.

Setup

1. Connect the unit under test as shown in Figure 2-35.

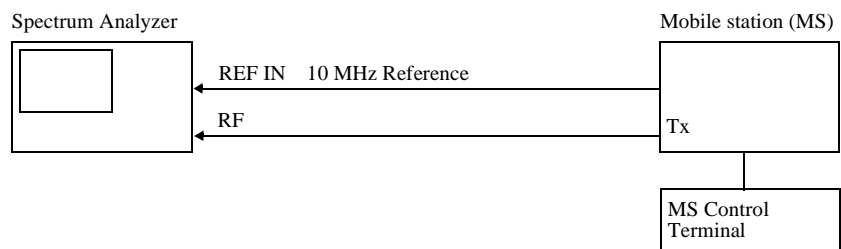

Figure 2-35 Setup for CCDF Measurement

Setting the measurement conditions

This changes the analyzer setting so that the input signal may be displayed more clearly.

2. Press **FREQ, 1, 9, 2, 2, ., 5** and **MHz**.
A center frequency of 1922.5 MHz is set.
3. Press **SPAN, 8** and **MHz**.
A frequency span of 8 MHz is set.
4. Press **COUPLE, RBW AUTO/MNL(MNL), 3, 0** and **kHz**.
An RBW of 30 kHz is set.
5. Press **VBW AUTO/MNL(MNL), 3, 0, 0** and **kHz**.
A VBW of 300 kHz is set.
6. Press **LEVEL, 0** and **GHz(+dBm)**.
The reference level is set to 0 dBm.

2.6 CCDF Measurement

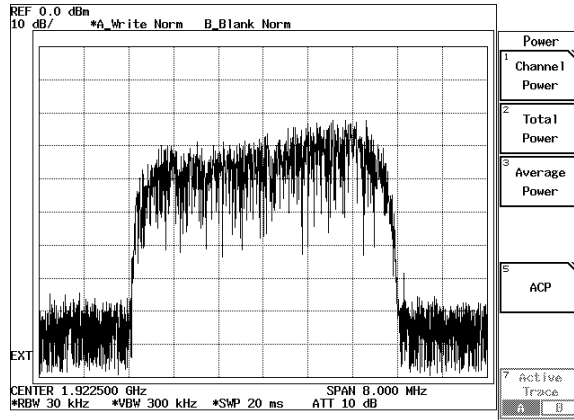

Figure 2-36 3GPP Signal Spectrum under Control of Transmission Power

CCDF Measurement

7. Press **TRANSIENT**, **Modulation**, **Power**, **CCDF**, **STD** and **Parameter Setup**. The Parameter Setup dialog box is displayed.
8. Select **OFF** from **Root Nyquist** using the data knob, and press **Hz(ENTR)**. The Root Nyquist filter is disabled.
9. Select **INT** from **Trigger Mode** using the data knob, and press **Hz(ENTR)**. The measurement mode is set to a mode that uses the internal trigger.
10. Press **1, 0, kHz(ENTR)** to set **Meas Length**. The number of measurement samples is set to 10k.

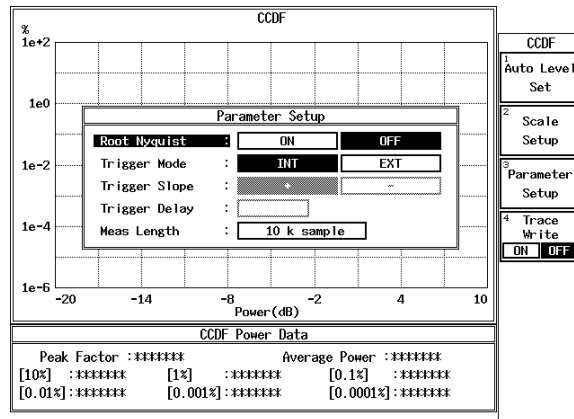

Figure 2-37 CCDF Parameter Setup Dialog Box

11. Press **Parameter Setup**.
The dialog box is removed.
12. Press **Auto Level Set**.
The measurement range is optimally set.
13. Press **SINGLE**.
The measurement mode is set to the single mode and the measurement mode is displayed.

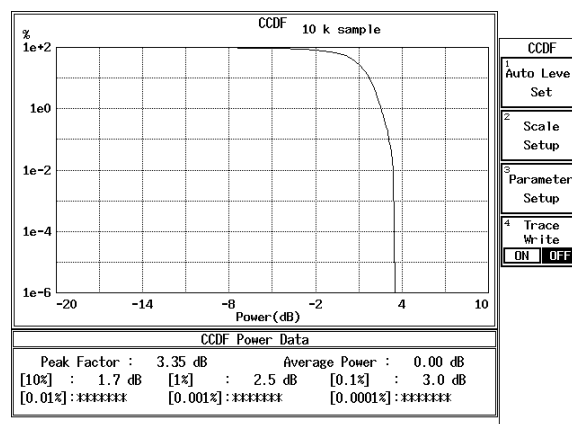

Figure 2-38 CCDF Measurement Result

Peak Factor	Peak factor
Average Power	Average power
[10%]	Power whose distribution is 10%
[1%]	Power whose distribution is 1%
[0.1%]	Power whose distribution is 0.1%
[0.01%]	Power whose distribution is 0.01%
[0.001%]	Power whose distribution is 0.001%
[0.0001%]	Power whose distribution is 0.0001%

Holding waveform

14. Press **Trace Write(ON)**.
The signal waveform is held.
15. Press **SINGLE**.
The measurement mode is set to **SINGLE** mode so that both the stored and current waveforms are displayed.

2.6 CCDF Measurement

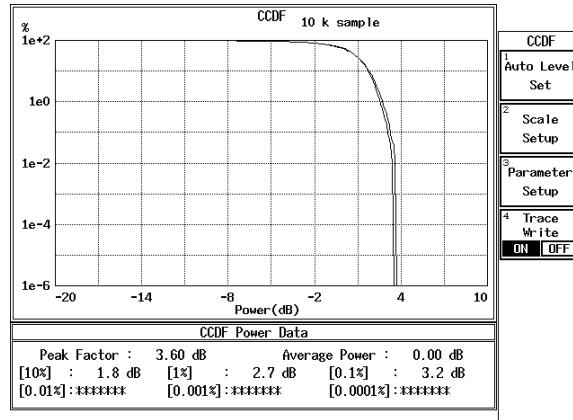

Figure 2-39 CCDF Measurement Result (Trace Write ON)

2.7 Measuring Primary CPICH Power

Primary CPICH power and carrier frequency error composite for the BTS signals can be measured.

Measurement conditions:

The measurement target is a unit which uses 3GPP mode with a frequency of 2112.5 MHz and a level of -10 dBm.

Signal specifications: Scrambling code number 0

Channel	Spreading Factor	Code Number
Primary CPICH	256 (15 ksps)	0
Primary CCPCH	256 (15 ksps)	1
SCH	256 (15 ksps)	-
Channel 1	128 (30 ksps)	2
Channel 2	128 (30 ksps)	3
Channel 3	128 (30 ksps)	4

Setup

1. Connect the unit under test as shown in Figure 2-40.

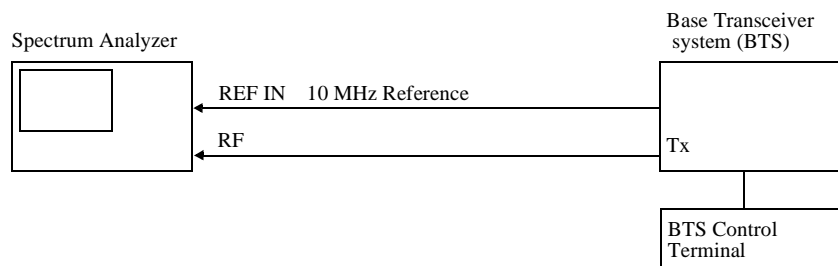

Figure 2-40 Setup for Primary CPICH Power Measurement

Setting the measurement conditions

Set the measurement conditions in order to easily observe the input signal.

2. Press **FREQ, 2, 1, 1, 2, ,, 5** and **MHz**.
The center frequency is set to 2112.5 MHz.
3. Press **SPAN, 8** and **MHz**.
The frequency span is set to 8 MHz.
4. Press **COUPLE, RBW AUTO/MNL(MNL), 3, 0** and **kHz**.
RBW is set to 30 kHz.
5. Press **VBW AUTO/MNL(MNL), 3, 0, 0** and **kHz**.
VBW is set to 300 kHz.

2.7 Measuring Primary CPICH Power

6. Press **LEVEL, 0** and **GHz(+dBm)**.
The reference level is set to 0 dBm.

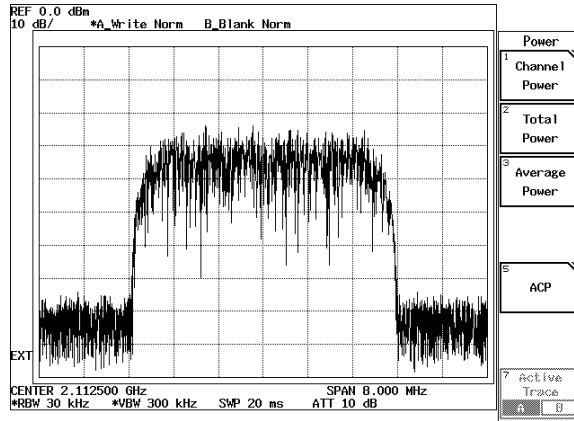

Figure 2-41 3GPP Signal Spectrum

7. Press **TRANSIENT, STD** and **STD Setup**.
The STD Measurement Parameter Set dialog box is displayed.

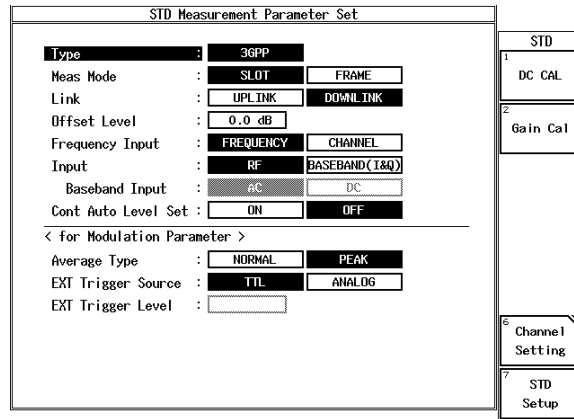

Figure 2-42 STD Measurement Parameter Set Dialog Box

8. Select **DOWNLINK** for **Link** using the data knob, and press **Hz(ENTR)**.
The measurement mode is set to the BTS measurement.

The other parameters are being set to the following settings as defaults:

Meas Mode: SLOT
 Offset Level: 0.0dB
 Frequency Input: FREQUENCY
 Input: RF
 Cont Auto Level Set: OFF
 Average Type: PEAK
 EXT Trigger Source: TTL

9. Press **RETURN**, *Modulation, Power, P-CPICH Power* and *Parameter Setup*. The Parameter Setup dialog box is displayed.

Parameter Setup	
Scrambling Code No. :	00000(0)
Search Mode :	SCH(LONG) Primary CPICH
Meas Frame :	1

Figure 2-43 Parameter Setup Dialog Box

10. Press **0** and **Hz(ENTR)** to set the *Scrambling Code No.*. The Scrambling Code No. is set to 0.
11. Select *SCH(LONG)* for *Search Mode* using the data knob, and press **Hz(ENTR)**. The synchronization mode using SCH is set.
12. Press **1** and **Hz(ENTR)** to set *Meas Frame*. The Meas Frame is set to 1.
13. Press *Parameter Setup*. The dialog box is closed.
14. Press *Auto Level Set*. The measurement range is set to the optimum range.
15. Press **SINGLE**. The measurement mode is set to single and the measurement results are displayed.

P-CPICH Power	
Results	
P-CPICH Power	
Average :	-19.05 dBm 12.45 μW
Max :	-19.03 dBm 12.49 μW
Min :	-19.07 dBm 12.39 μW
Frequency Error :	-0.01 Hz
Tx Power :	-10.02 dBm
	99.50 μW
	(Offset : 0.0 dB)

P-CPICH Pwr
Auto Level Set
Parameter Setup
Average Times
ON OFF

Figure 2-44 P-CPICH Power Measurement Results

P-CPICH Power

Average	Average power of P-CPICH (dBm, W)
Max	Maximum power of P-CPICH (dBm, W)
Min	Minimum power of P-CPICH (dBm, W)

2.7 Measuring Primary CPICH Power

Frequency Error
Tx Power

A carrier frequency error (Hz)
Signal power (dBm, W)

3 REFERENCE

This chapter describes the functions of the panel and soft keys for option 62 software.

3.1 Menu Index

This menu index is used to easily find the keys described in Chapter 3.

<u>Operation Key</u>	<u>Pages</u>	<u>Operation Key</u>	<u>Pages</u>
3GPP	3-7, 3-19		3-33, 3-35,
45deg Turn.....	3-19, 3-61		3-39, 3-40,
Active CH. Detection.....	3-20, 3-65,		3-43, 3-47,
	3-69		3-50, 3-53,
Analysis Rate	3-20, 3-21,		3-55, 3-75,
	3-65, 3-71		3-78, 3-80,
Auto Level Set	3-8, 3-9,		3-85, 3-87
	3-10, 3-11,	Average Type.....	3-7, 3-25,
	3-12, 3-13,		3-88
	3-14, 3-16,	Band Conversion.....	3-17
	3-17, 3-18,	Baseband Input	3-7, 3-25,
	3-19, 3-22,		3-88
	3-23, 3-24,	CCDF	3-7, 3-23
	3-28, 3-31,	Channel Setting.....	3-7, 3-25,
	3-34, 3-37,		3-87
	3-40, 3-42,	Code	3-19, 3-59
	3-45, 3-49,	Config	3-8, 3-9,
	3-52, 3-55,		3-10, 3-11,
	3-57, 3-76,		3-12, 3-13,
	3-79, 3-80,		3-14, 3-16,
	3-83, 3-84,		3-17, 3-18,
	3-86		3-30, 3-33,
Average Mode.....	3-8, 3-9,		3-35, 3-39,
	3-10, 3-11,		3-40, 3-43,
	3-12, 3-13,		3-47, 3-50,
	3-15, 3-16,		3-53, 3-55
	3-17, 3-18,	Constellation	3-19, 3-22,
	3-31, 3-33,		3-60, 3-76
	3-36, 3-40,	Constellation(Dot)	3-19, 3-22,
	3-41, 3-44,		3-60, 3-61,
	3-48, 3-51,		3-76
	3-54, 3-56	Constellation(Line & Chip)	3-19, 3-22,
Average Times ON/OFF.....	3-8, 3-9,		3-60, 3-76
	3-10, 3-11,	Constellation(Line & Symbol).....	3-61
	3-12, 3-13,	Constellation(Line)	3-19, 3-22,
	3-14, 3-16,		3-60, 3-61,
	3-17, 3-18,		3-76
	3-19, 3-22,	Cont Auto Level Set	3-7, 3-25,
	3-24, 3-30,		3-88

3.1 Menu Index

Copy from STD	3-7, 3-13, 3-14, 3-16, 3-17, 3-18, 3-25, 3-42, 3-47, 3-49, 3-50, 3-52, 3-55, 3-87		
DC CAL	3-7, 3-25, 3-87		
Delay Time	3-8, 3-9, 3-10, 3-11, 3-14, 3-29, 3-32, 3-34, 3-38, 3-45		
Delete	3-18		
Delete Line.....	3-8, 3-10, 3-13, 3-14, 3-16, 3-17, 3-30, 3-35, 3-42, 3-47, 3-49, 3-50, 3-52, 3-53, 3-55		
Demod Data Save	3-19, 3-61		
Detector.....	3-8, 3-9, 3-10, 3-11, 3-12, 3-13, 3-14, 3-15, 3-16, 3-17, 3-18, 3-30, 3-33, 3-35, 3-38, 3-39, 3-41, 3-43, 3-46, 3-47, 3-50, 3-53, 3-56		
Display	3-19, 3-57		
Display Start	3-19, 3-22, 3-59, 3-76		
Display Type.....	3-19, 3-23, 3-57, 3-80		
Display Unit.....	3-8, 3-9, 3-10, 3-11, 3-13, 3-15, 3-16, 3-17, 3-18, 3-30, 3-33, 3-35, 3-39, 3-44, 3-48, 3-51, 3-54, 3-56		
DPCCH No.	3-21, 3-71,		3-73
		DPCCH SF.....	3-21, 3-71, 3-73
		Due to Modulation	3-7
		Due to Transient.....	3-7
		E.V.M. vs Chip	3-19, 3-22, 3-60, 3-77
		E.V.M. vs Symbol.....	3-19, 3-59, 3-61
		Ext Gate	3-11, 3-14, 3-38, 3-46
		EXT Trigger Delay	3-20, 3-21, 3-22, 3-65, 3-68, 3-71, 3-73, 3-78, 3-79
		EXT Trigger Level.....	3-7, 3-25, 3-89
		EXT Trigger Slope.....	3-20, 3-21, 3-22, 3-65, 3-68, 3-71, 3-73, 3-77, 3-79
		EXT Trigger Source.....	3-7, 3-25, 3-89
		F-Domain	3-7
		Format.....	3-19, 3-57
		Freq. Setting	3-13, 3-15, 3-16, 3-17, 3-43, 3-47, 3-50, 3-53
		Frequency Error	3-20, 3-21, 3-67, 3-72
		Frequency Input	3-7, 3-25, 3-88
		Gain Cal	3-7, 3-25, 3-87
		Gate Position.....	3-11, 3-14, 3-38, 3-46
		Gate Setup.....	3-11, 3-14, 3-37, 3-38, 3-45, 3-46
		Gate Source.....	3-11, 3-14, 3-38, 3-46
		Gate Width.....	3-11, 3-14, 3-38, 3-46
		Gated Sweep	3-11, 3-39
		Gated Sweep ON/OFF	3-11, 3-14, 3-38, 3-46
		Graph Plot Type.....	3-23, 3-82
		Graphics	3-19, 3-22,

I EYE Diagram	3-59, 3-76 3-19, 3-22, 3-59, 3-60, 3-61, 3-76	3-16, 3-17, 3-42, 3-47, 3-50, 3-52
I/Q EYE Diagram	3-19, 3-22, 3-60, 3-61, 3-77	Marker Setup..... 3-23, 3-82 Meas Branch 3-21, 3-74 Meas Channel No..... 3-20, 3-21, 3-69, 3-73 Meas Channel SF 3-20, 3-21, 3-69, 3-73 Meas Frame..... 3-24, 3-85 Meas Length 3-23, 3-82, 3-84 Meas Mode 3-7, 3-20, 3-21, 3-23, 3-25, 3-64, 3-70, 3-81, 3-87 Meas Range..... 3-22, 3-77 Meas Slots..... 3-20, 3-21, 3-69, 3-74 Meas Start Position 3-20, 3-21, 3-66, 3-69, 3-72, 3-74 Meas Unit..... 3-20, 3-21, 3-66, 3-71 Modulation..... 3-7 Multi Channel No. 3-19, 3-62 Multiplier 3-10, 3-35 OBW 3-7 OBW% 3-12, 3-40 OFF Position 3-9, 3-32 OFF Width 3-9, 3-32 Offset Level 3-7, 3-25, 3-88 Omit Transient Section for AVG Power.. 3-23, 3-82 ON Position..... 3-9, 3-32 ON Width..... 3-9, 3-32 ON/OFF Ratio..... 3-7, 3-9 Outband Spurious 3-7 Page..... 3-19, 3-59 Parameter Setup 3-8, 3-9, 3-10, 3-11, 3-12, 3-13, 3-14, 3-16, 3-17, 3-18, 3-19, 3-22, 3-23, 3-24, 3-30, 3-33, 3-35, 3-39, 3-41, 3-43, 3-47, 3-50,
Ich & Qch Time	3-24	
Ich Time & FFT	3-24	
Inband Spurious (1)	3-7, 3-16	
Inband Spurious (2)	3-7, 3-17	
Input	3-7, 3-25, 3-88	
Insert Line	3-8, 3-10, 3-13, 3-14, 3-16, 3-17, 3-18, 3-29, 3-35, 3-42, 3-47, 3-49, 3-50, 3-52, 3-55	
Integral Band.....	3-17, 3-54	
IQ Complex FFT.....	3-24	
Judgment	3-8, 3-9, 3-10, 3-11, 3-12, 3-13, 3-15, 3-16, 3-17, 3-18, 3-22, 3-30, 3-33, 3-36, 3-39, 3-41, 3-44, 3-48, 3-51, 3-54, 3-56, 3-78	
Limit (p).....	3-22, 3-78	
Limit Setup	3-22, 3-78	
Link	3-7, 3-25, 3-88	
Load Table	3-10, 3-18, 3-35, 3-55	
Lower Limit	3-8, 3-11, 3-12, 3-31, 3-39, 3-41	
Mag Error vs Chip	3-19, 3-22, 3-60, 3-77	
Mag Error vs Symbol.....	3-61	
Margin ΔX ON/OFF	3-13, 3-14, 3-16, 3-17, 3-42, 3-46, 3-49, 3-52	
Marker Edit	3-13, 3-14,	

3.1 Menu Index

	3-53, 3-55,		3-35, 3-55
	3-63, 3-77,	Scale Setup.....	3-23, 3-80,
	3-79, 3-81,		3-83
	3-83, 3-84,	SCH Power	3-19, 3-61
	3-86	Scrambling Code Define.....	3-20, 3-64,
P-CPICH Power	3-24		3-67
Peak CDE.....	3-20, 3-64	Scrambling Code No.....	3-20, 3-21,
Peak MKR Y Delta	3-10, 3-16,		3-24, 3-64,
	3-17, 3-18,		3-68, 3-71,
	3-35, 3-50,		3-73, 3-85
	3-53, 3-56	Search Mode	3-20, 3-24,
Phase Error vs Chip	3-19, 3-22,		3-65, 3-68,
	3-60, 3-77		3-85
Phase Error vs Symbol.....	3-61	Select Type	3-19, 3-22,
Phase Inverse	3-20, 3-21,		3-24, 3-59,
	3-67, 3-70,		3-76, 3-86
	3-72, 3-75	Set to Default	3-10, 3-18,
Power	3-7, 3-22,		3-36, 3-56
	3-23, 3-24	Set to STD.....	3-8, 3-9,
Power Marker 1	3-23, 3-82		3-11, 3-12,
Power Marker 2	3-23, 3-82		3-13, 3-14,
Power Unit	3-23, 3-80,		3-16, 3-17,
	3-83		3-29, 3-31,
Power vs Time	3-7, 3-23		3-32, 3-33,
Preselector.....	3-10, 3-18,		3-38, 3-39,
	3-36, 3-56		3-40, 3-41,
Primary CPICH No.....	3-20, 3-65,		3-44, 3-46,
	3-69		3-49, 3-51,
Primary CPICH SF	3-20, 3-65,		3-55
	3-69	SF/Number/Rate	3-19, 3-62
Q EYE Diagram.....	3-19, 3-22,	Shift X.....	3-8, 3-13,
	3-59, 3-60,		3-14, 3-16,
	3-61, 3-77		3-17, 3-29,
Qch Time & FFT	3-24		3-42, 3-46,
QPSK	3-7, 3-22,		3-49, 3-52
	3-76	Shift Y	3-8, 3-13,
Ref Power	3-13, 3-15,		3-14, 3-16,
	3-16, 3-17,		3-17, 3-29,
	3-43, 3-48,		3-42, 3-46,
	3-51, 3-53		3-49, 3-52
Result	3-10, 3-13,	Slope	3-8, 3-9,
	3-15, 3-16,		3-10, 3-11,
	3-17, 3-35,		3-14, 3-29,
	3-43, 3-48,		3-32, 3-34,
	3-50, 3-53		3-37, 3-45
Rolloff Factor.....	3-13, 3-15,	Sort.....	3-8, 3-13,
	3-44, 3-48		3-14, 3-16,
Root Nyquist	3-22, 3-23,		3-17, 3-30,
	3-77, 3-79,		3-42, 3-47,
	3-81, 3-84		3-50, 3-52,
Save Table.....	3-10, 3-18,		3-53

Spurious	3-7	Template UP/LOW	3-8, 3-29
Start Offset	3-17, 3-54	Test Model 1 DPCH 16 code	3-19, 3-61
STD	3-7, 3-25	Test Model 1 DPCH 32 code	3-19, 3-61
STD Setup	3-7, 3-25, 3-87	Test Model 1 DPCH 64 code	3-19, 3-62
Stop Offset	3-17, 3-54	Test Model 2	3-19, 3-62
Symbol Rate 1/T	3-13, 3-15, 3-44, 3-48	Test Model 3 DPCH 16 code	3-19, 3-62
Table Edit	3-10, 3-18, 3-19, 3-35, 3-55, 3-62	Test Model 3 DPCH 32 code	3-19, 3-62
Table Init	3-8, 3-10, 3-13, 3-14, 3-16, 3-17, 3-18, 3-30, 3-35, 3-42, 3-43, 3-47, 3-50, 3-52, 3-53, 3-55	Threshold	3-20, 3-21, 3-66, 3-70, 3-72, 3-74
Table No. 1/2/3	3-10, 3-18, 3-34, 3-35, 3-55	Time	3-19, 3-59
T-Domain	3-7, 3-28	Time & FFT	3-7, 3-24
Template	3-8, 3-13, 3-14, 3-16, 3-17, 3-29, 3-42, 3-46, 3-49, 3-52	Trace Write ON/OFF	3-23, 3-84
Template 1	3-23, 3-83	Transmit Timing	3-20, 3-67
Template 2	3-23, 3-83	Trigger	3-11, 3-14, 3-38, 3-46
Template Couple to Power	3-8, 3-13, 3-15, 3-16, 3-17, 3-30, 3-44, 3-48, 3-51, 3-54	Trigger Delay	3-23, 3-24, 3-82, 3-84, 3-87
Template Edit	3-8, 3-13, 3-14, 3-16, 3-17, 3-29, 3-42, 3-46, 3-49, 3-52	Trigger Level	3-8, 3-9, 3-10, 3-11, 3-14, 3-22, 3-23, 3-24, 3-29, 3-32, 3-34, 3-38, 3-45, 3-77, 3-81, 3-86
Template Limit	3-8, 3-13, 3-15, 3-16, 3-17, 3-30, 3-44, 3-48, 3-51, 3-54	Trigger Mode	3-20, 3-21, 3-22, 3-23, 3-64, 3-68, 3-71, 3-73, 3-77, 3-79, 3-81, 3-84
Template ON/OFF	3-8, 3-14, 3-16, 3-17, 3-29, 3-42, 3-46, 3-49, 3-52	Trigger Position	3-8, 3-9, 3-10, 3-11, 3-14, 3-29, 3-32, 3-34, 3-38, 3-45
Template Setup	3-23, 3-82	Trigger Setup	3-8, 3-9, 3-10, 3-11, 3-14, 3-28, 3-31, 3-34, 3-37, 3-45
		Trigger Slope	3-23, 3-24, 3-81, 3-84, 3-86
		Trigger Source	3-8, 3-9, 3-10, 3-11, 3-14, 3-24, 3-28, 3-32, 3-34, 3-37,

3.1 Menu Index

	3-45, 3-86
Tx Power.....	3-7, 3-22
Type	3-7, 3-25, 3-87
Upper Limit.....	3-8, 3-9, 3-11, 3-12, 3-31, 3-33, 3-39, 3-41
User Table.....	3-19, 3-61
View Point	3-19, 3-59
Window ON/OFF	3-8, 3-9, 3-11, 3-29, 3-32, 3-39
Window Position.....	3-8, 3-11, 3-29, 3-39
Window Setup.....	3-8, 3-9, 3-11, 3-29, 3-32, 3-39
Window Width.....	3-8, 3-11, 3-29, 3-39
X Scale	3-19, 3-58
X Scale Max.....	3-23, 3-83
X Scale Range.....	3-23, 3-83
Y Scale	3-19, 3-57
Y Scale [dB/div] 10/5/2	3-8, 3-9, 3-11, 3-30, 3-32, 3-39
Y Scale Range.....	3-23, 3-80
Y Scale Upper	3-23, 3-80

3.2 Menu Map

This section shows the hierarchical menu configuration on a panel key basis.

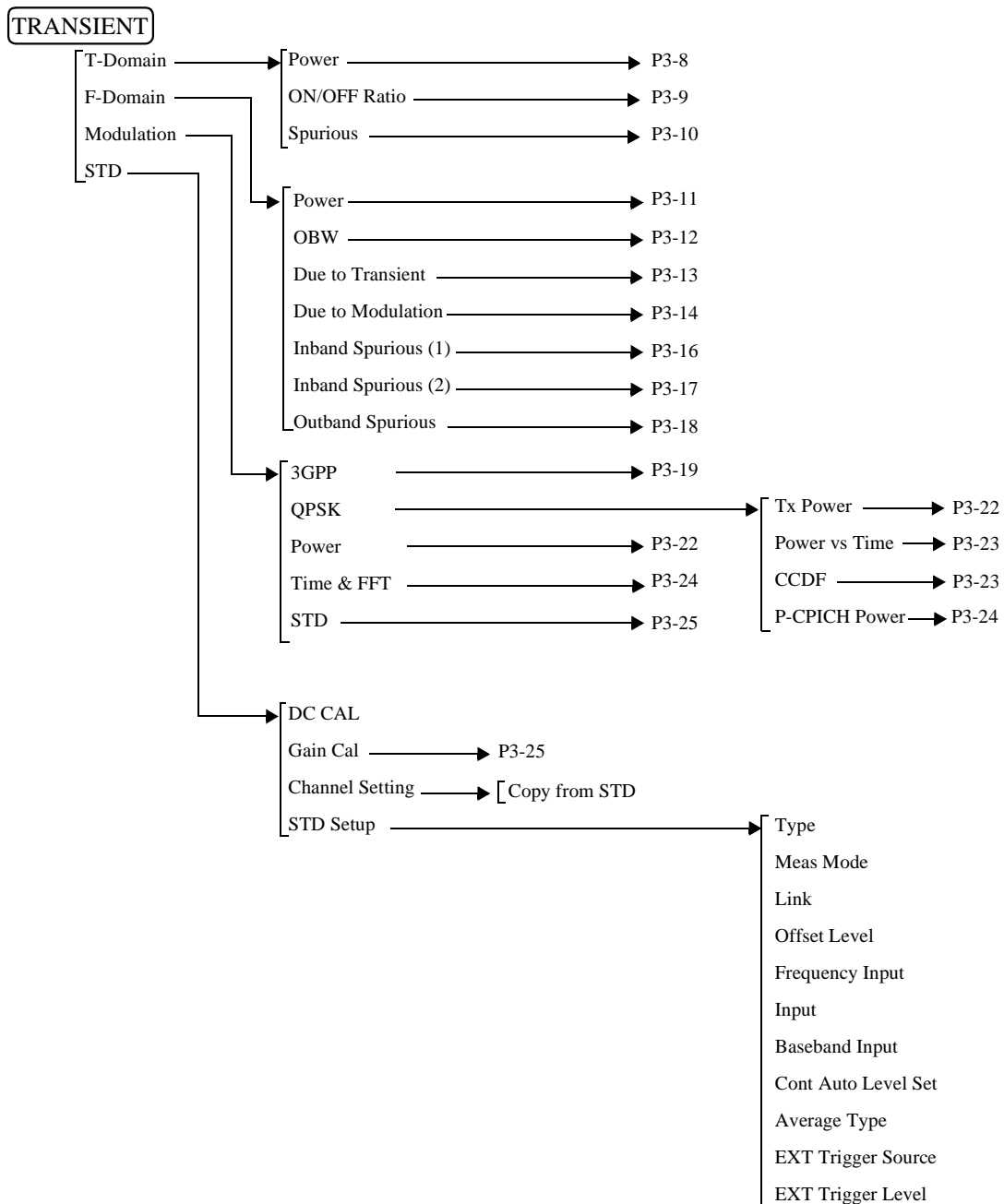

3.2 Menu Map

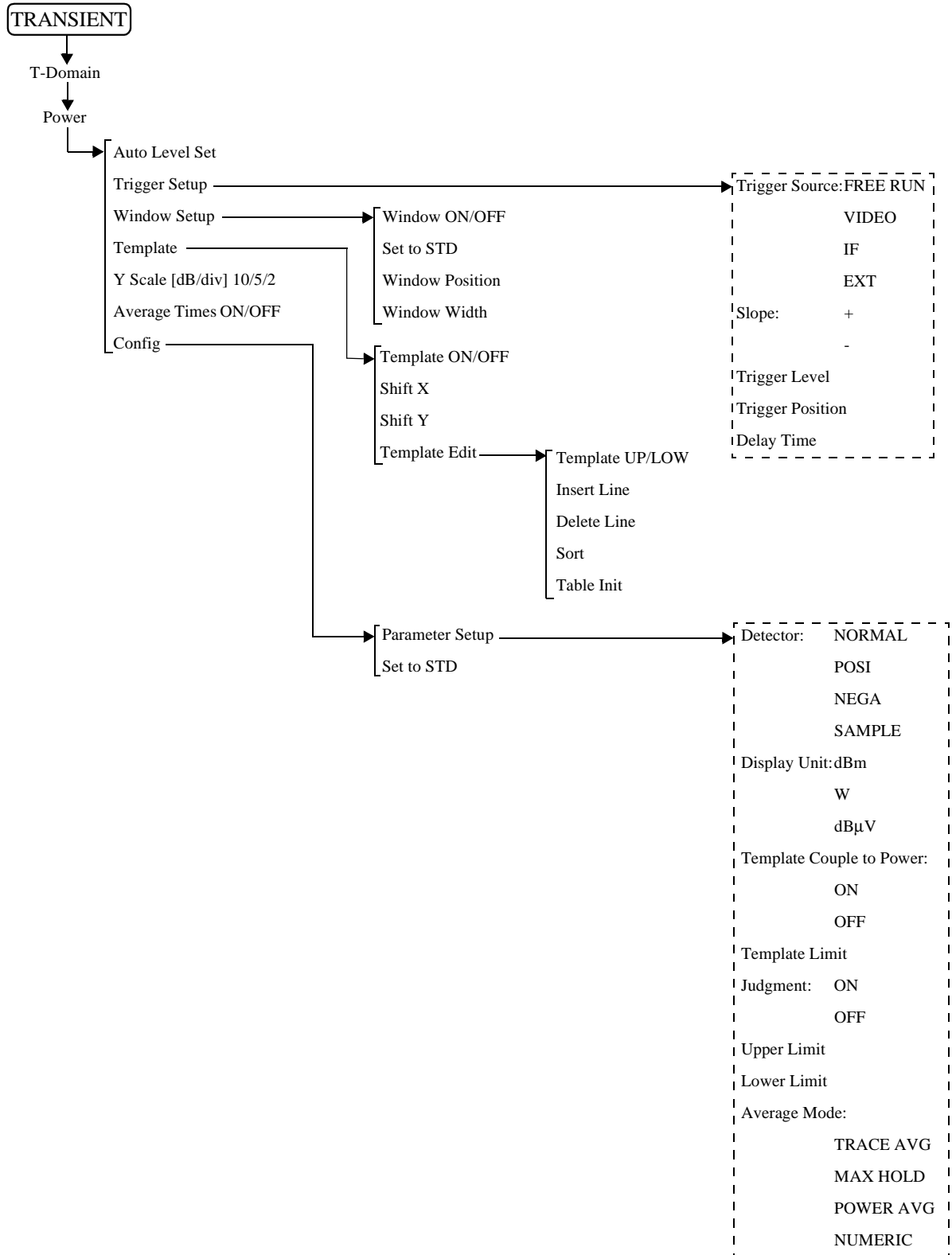

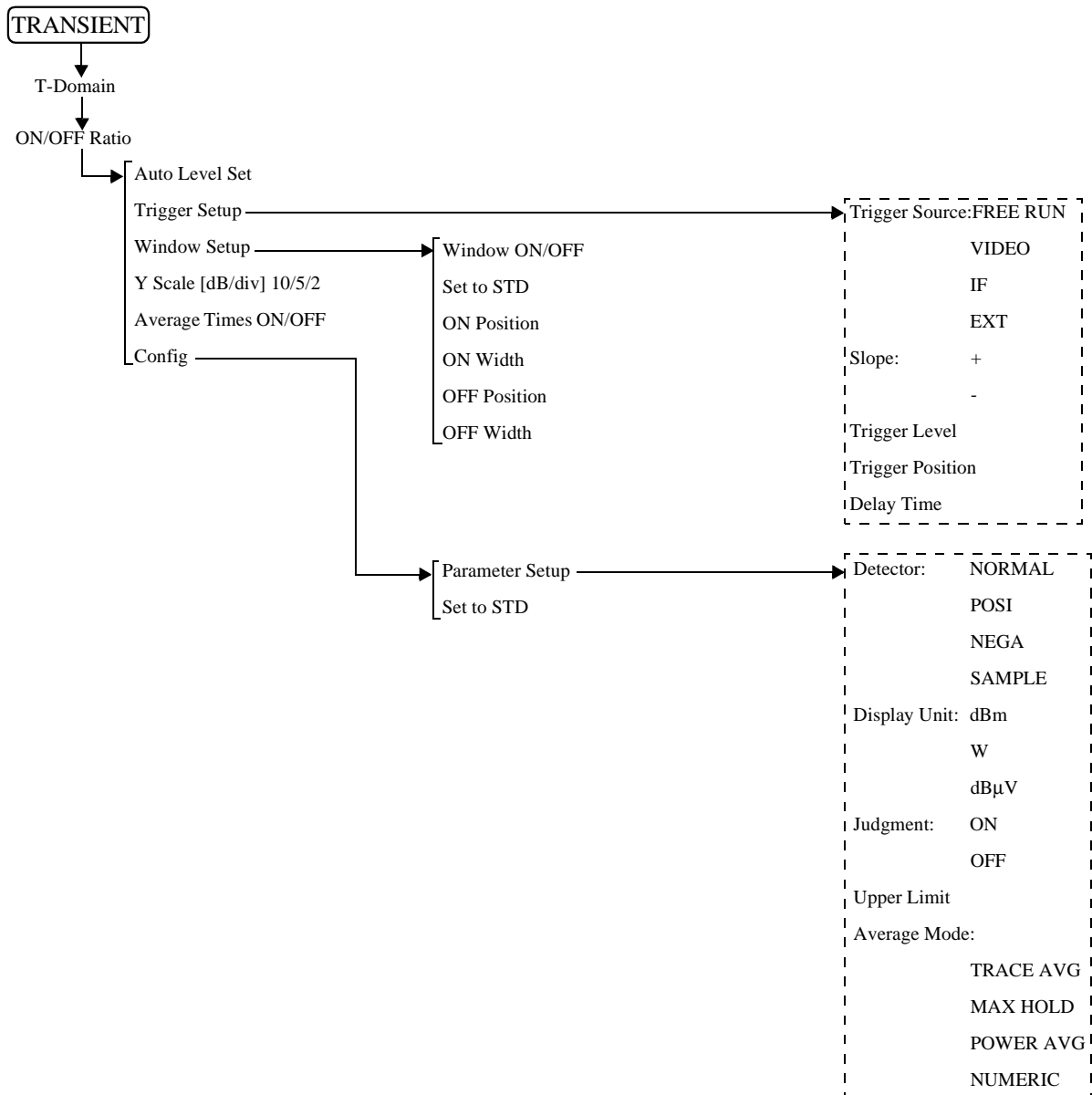

3.2 Menu Map

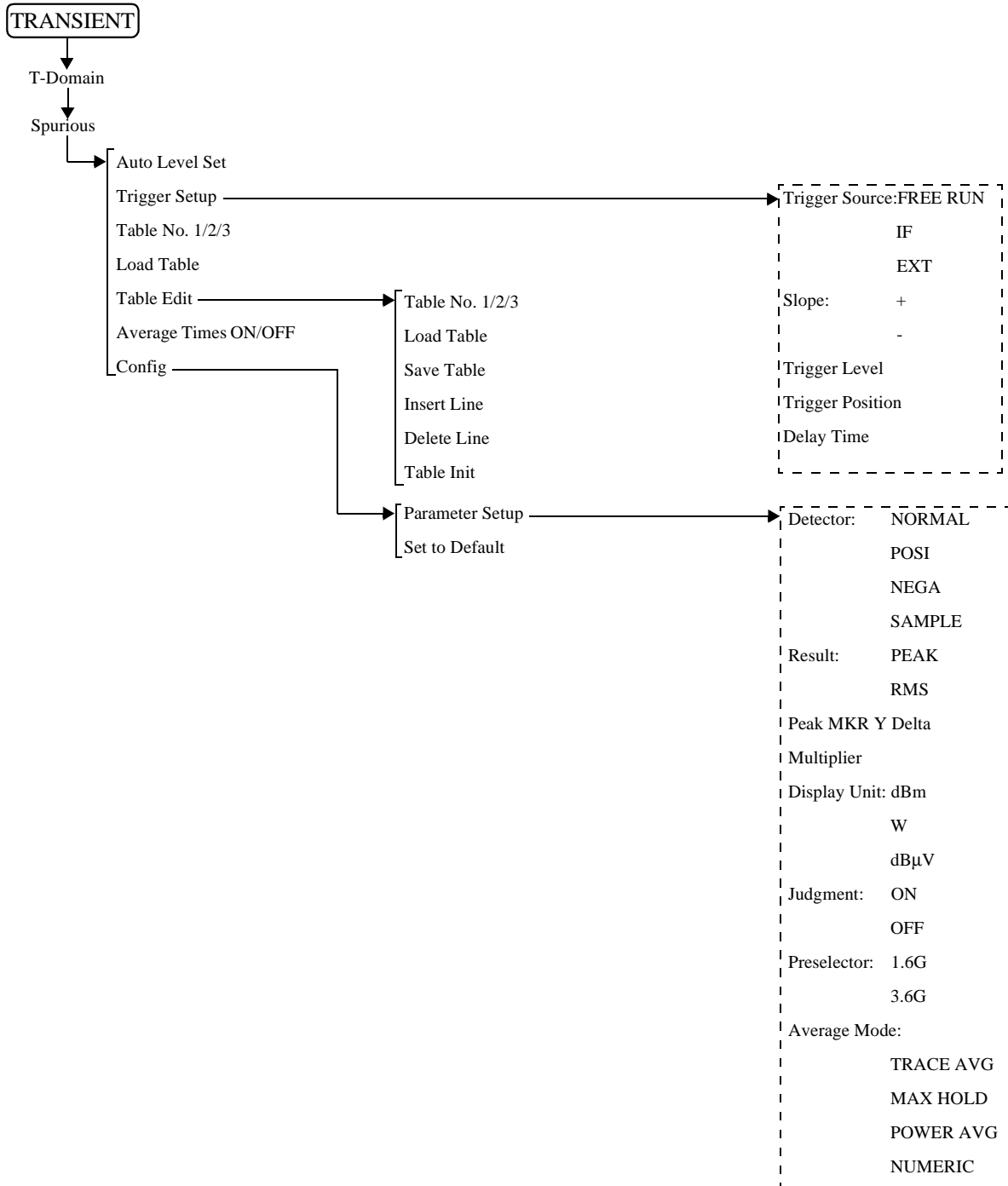

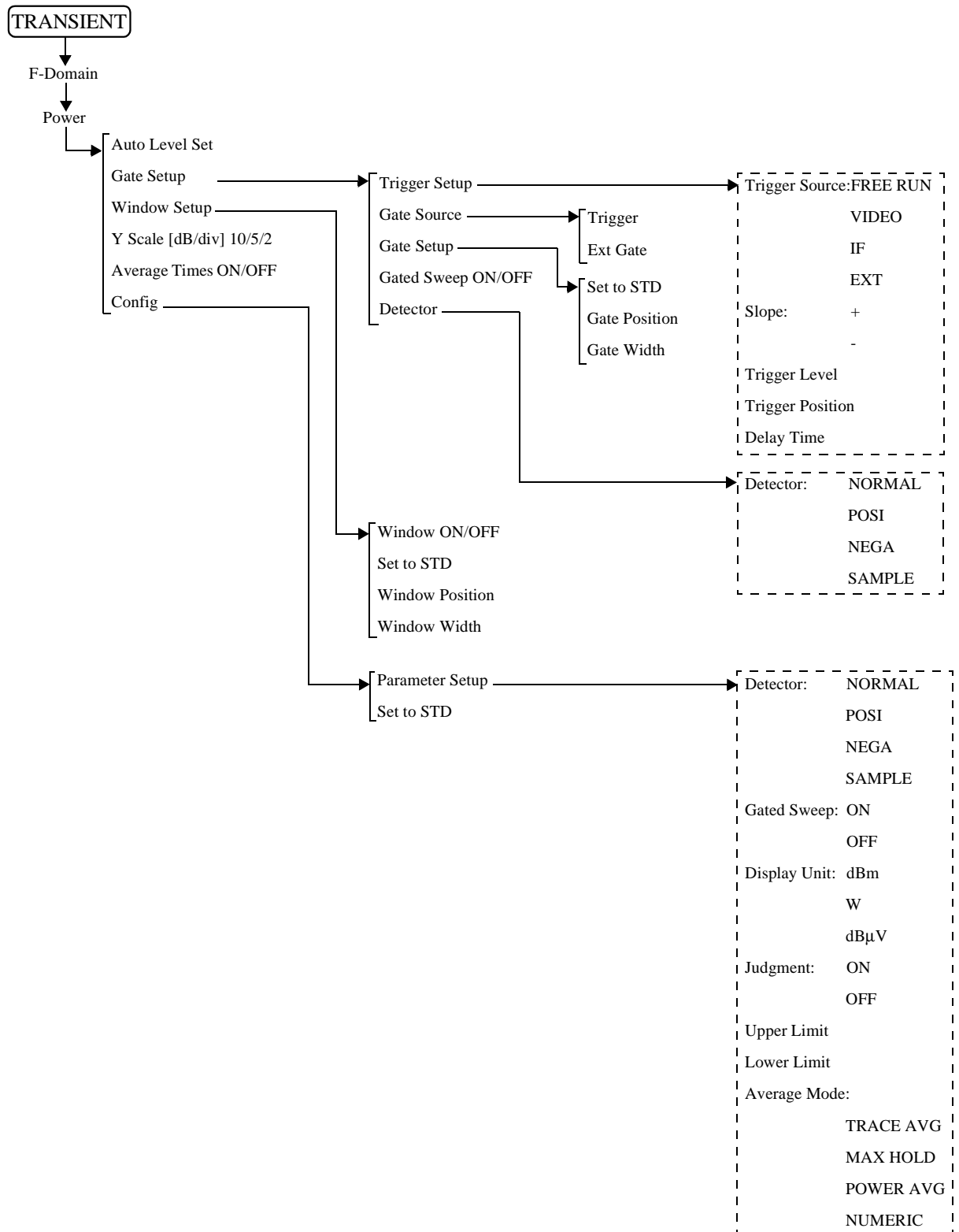

3.2 Menu Map

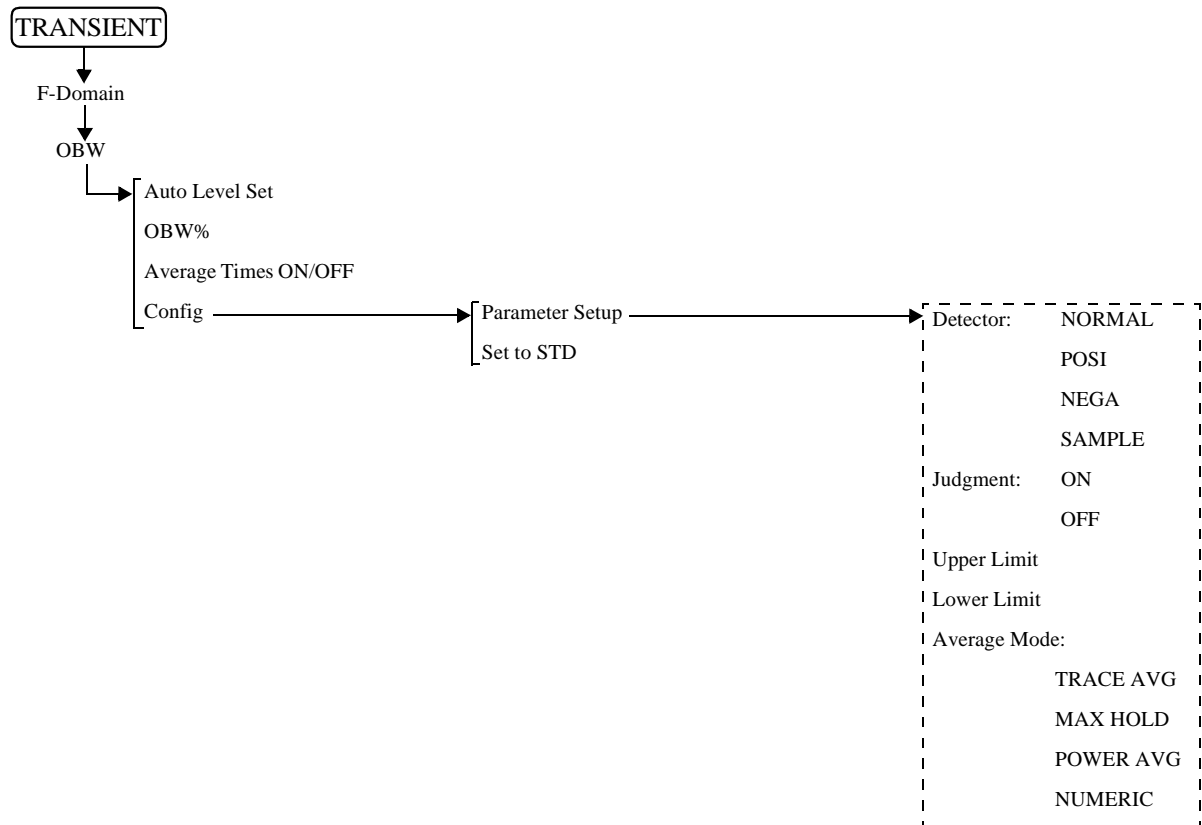

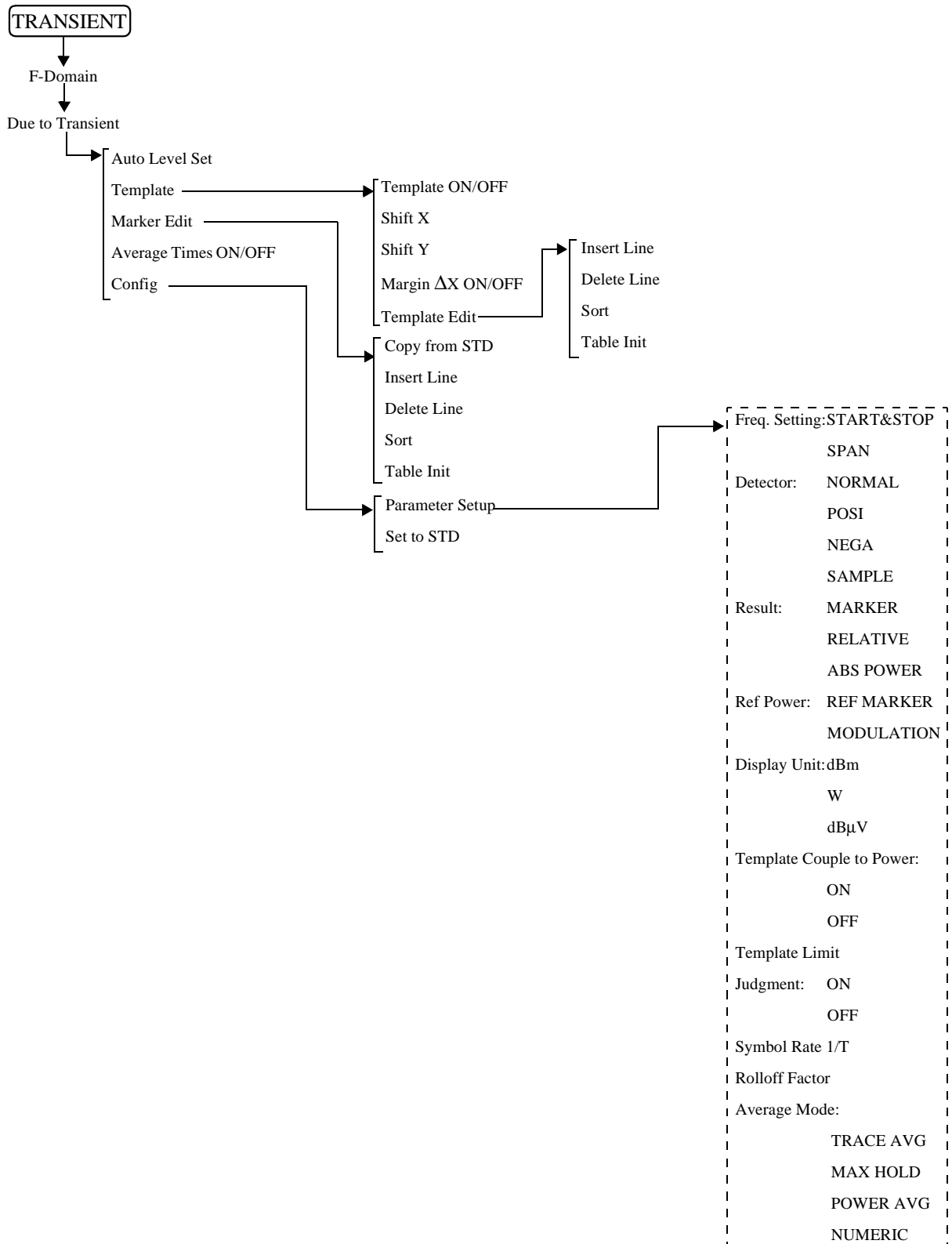

3.2 Menu Map

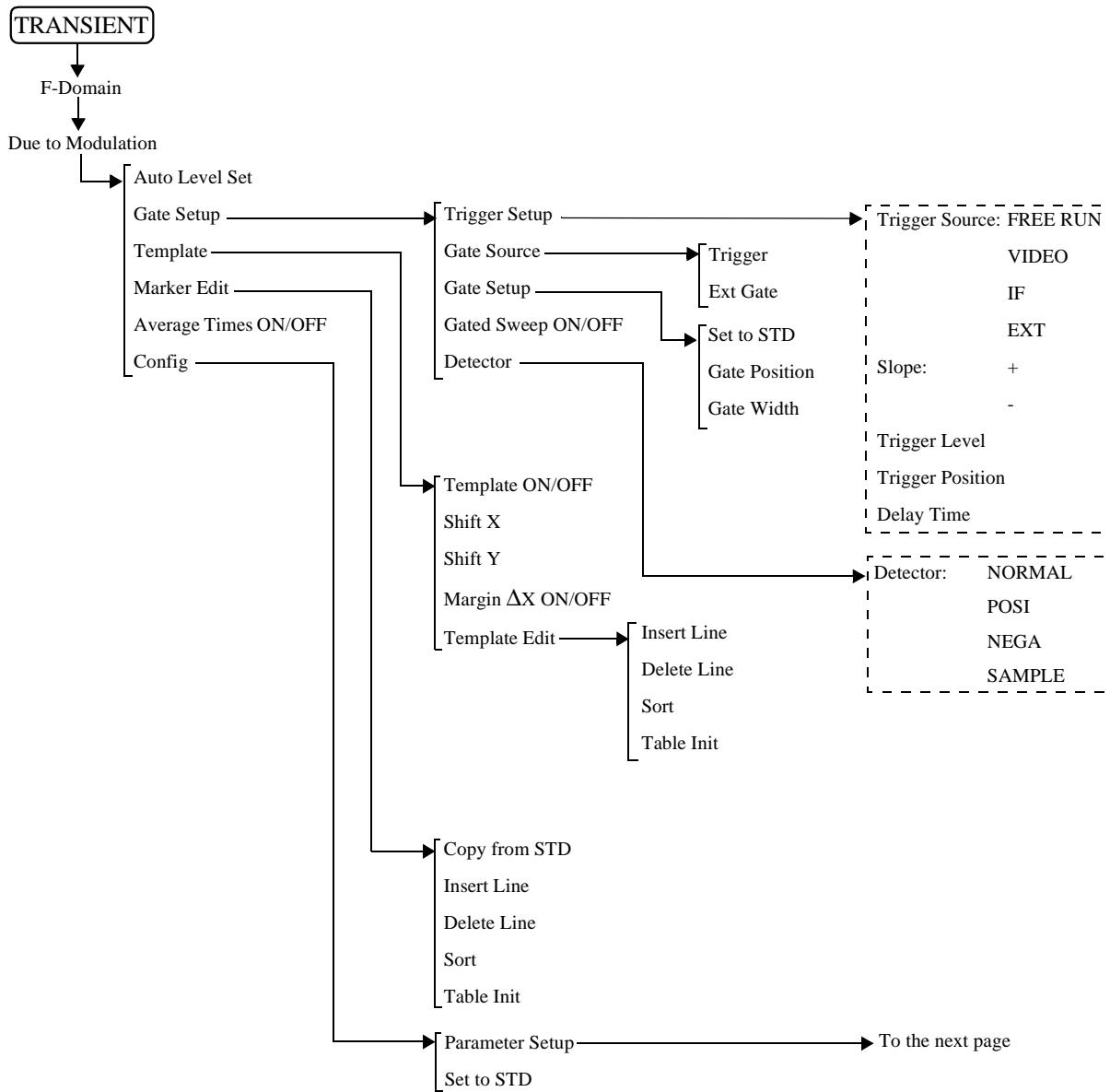

From the previous page →

Freq. Setting:	START&STOP
	SPAN
Detector:	NORMAL
	POSI
	NEGA
	SAMPLE
Result:	MARKER
	RELATIVE
	ABS POWER
Ref Power:	REF MARKER
	MODULA-
	TION
Display Unit:	dBm
	W
	dB μ V
Template Couple to Power:	
	ON
	OFF
Template Limit	
Judgment:	ON
	OFF
Symbol Rate 1/T	
Rolloff Factor	
Average Mode:	
	TRACE AVG
	MAX HOLD
	POWER AVG
	NUMERIC

3.2 Menu Map

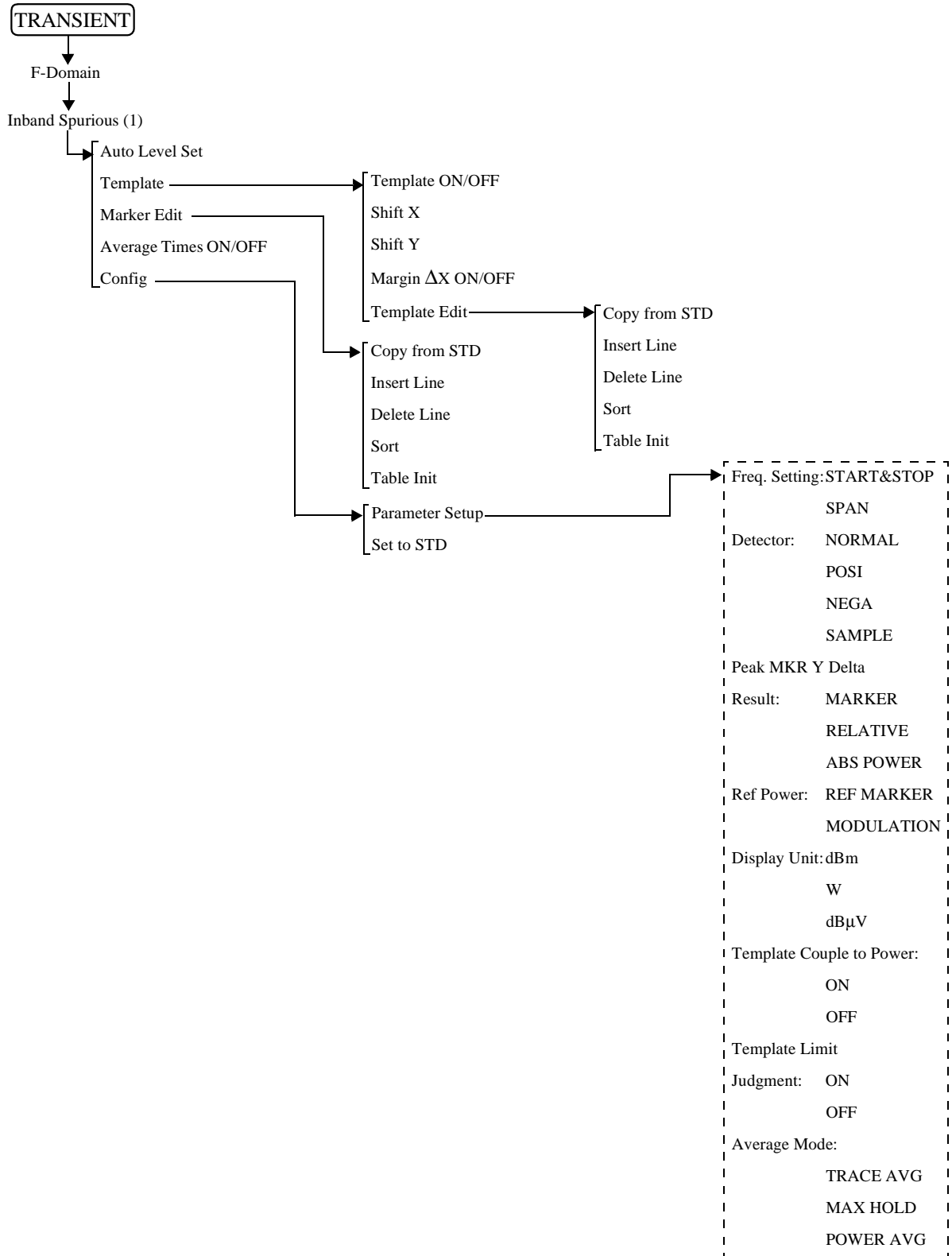

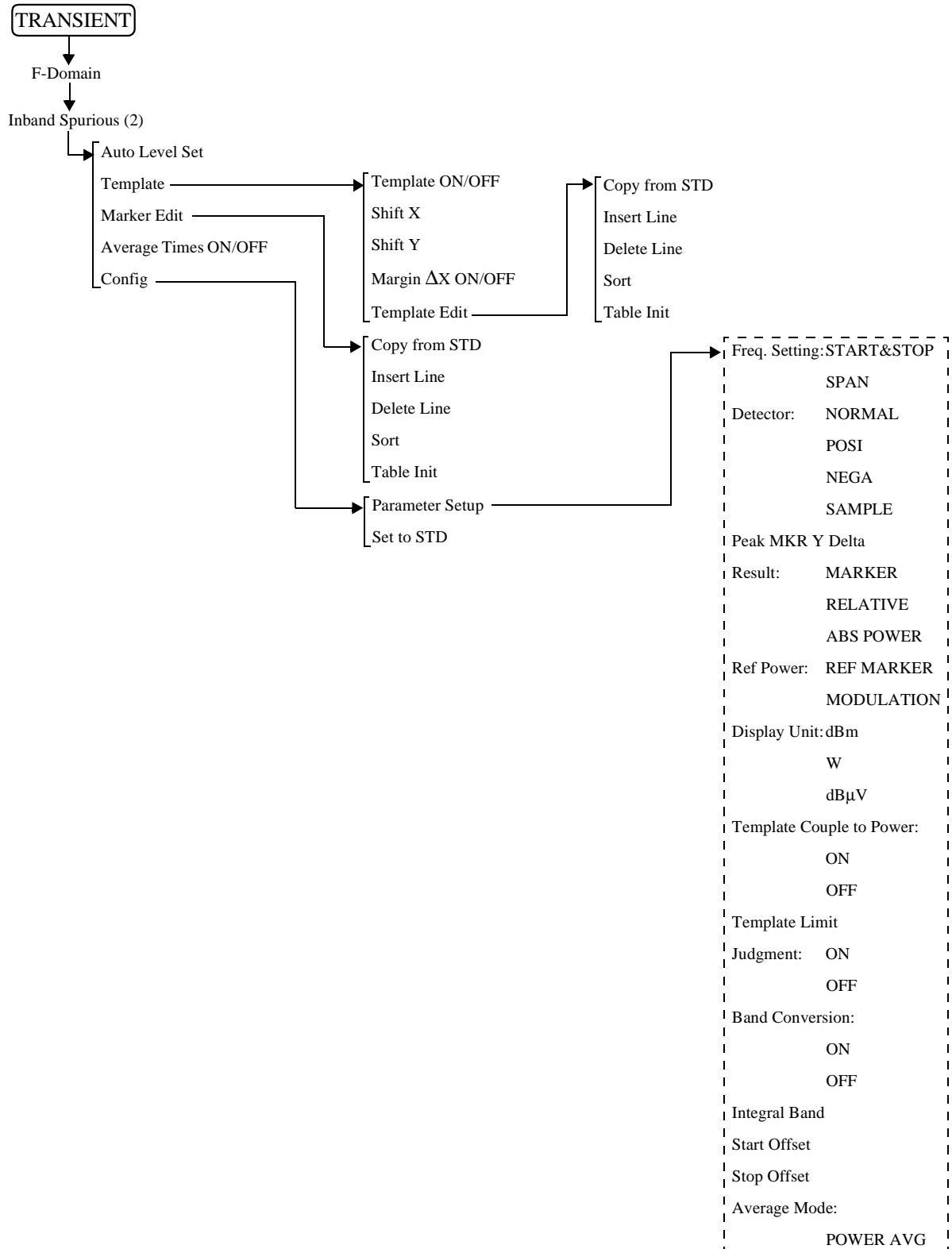

3.2 Menu Map

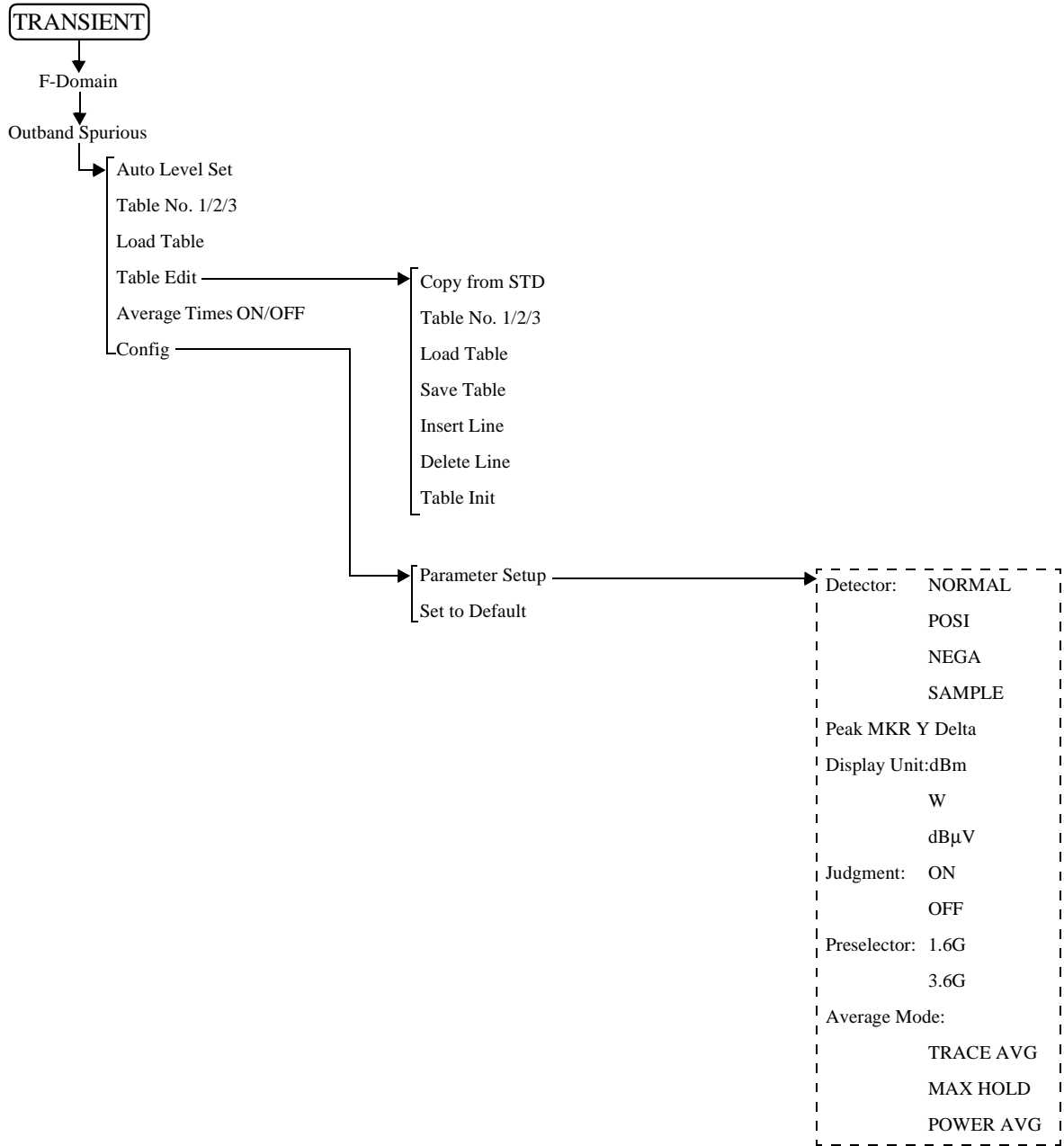

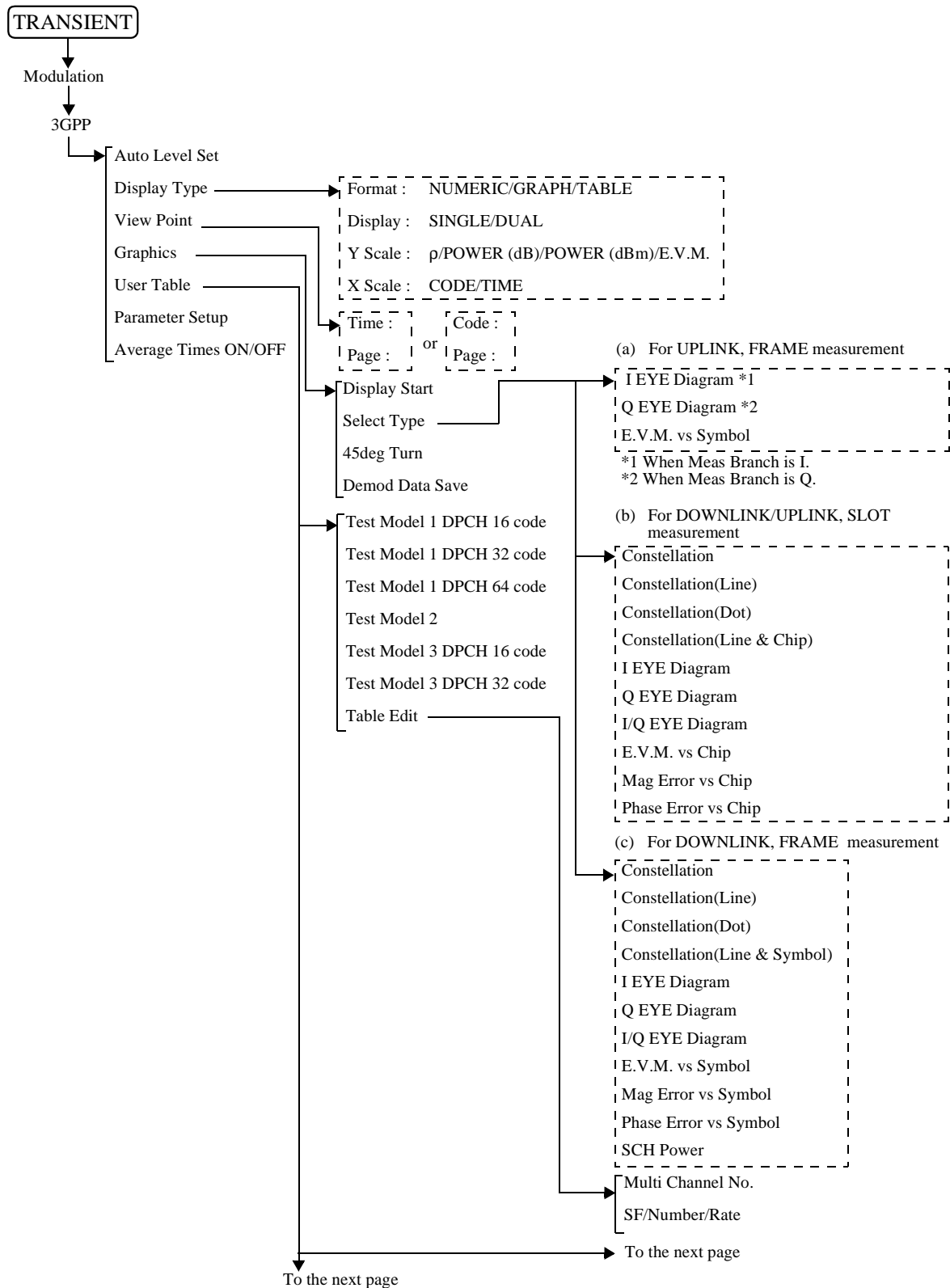

3.2 Menu Map

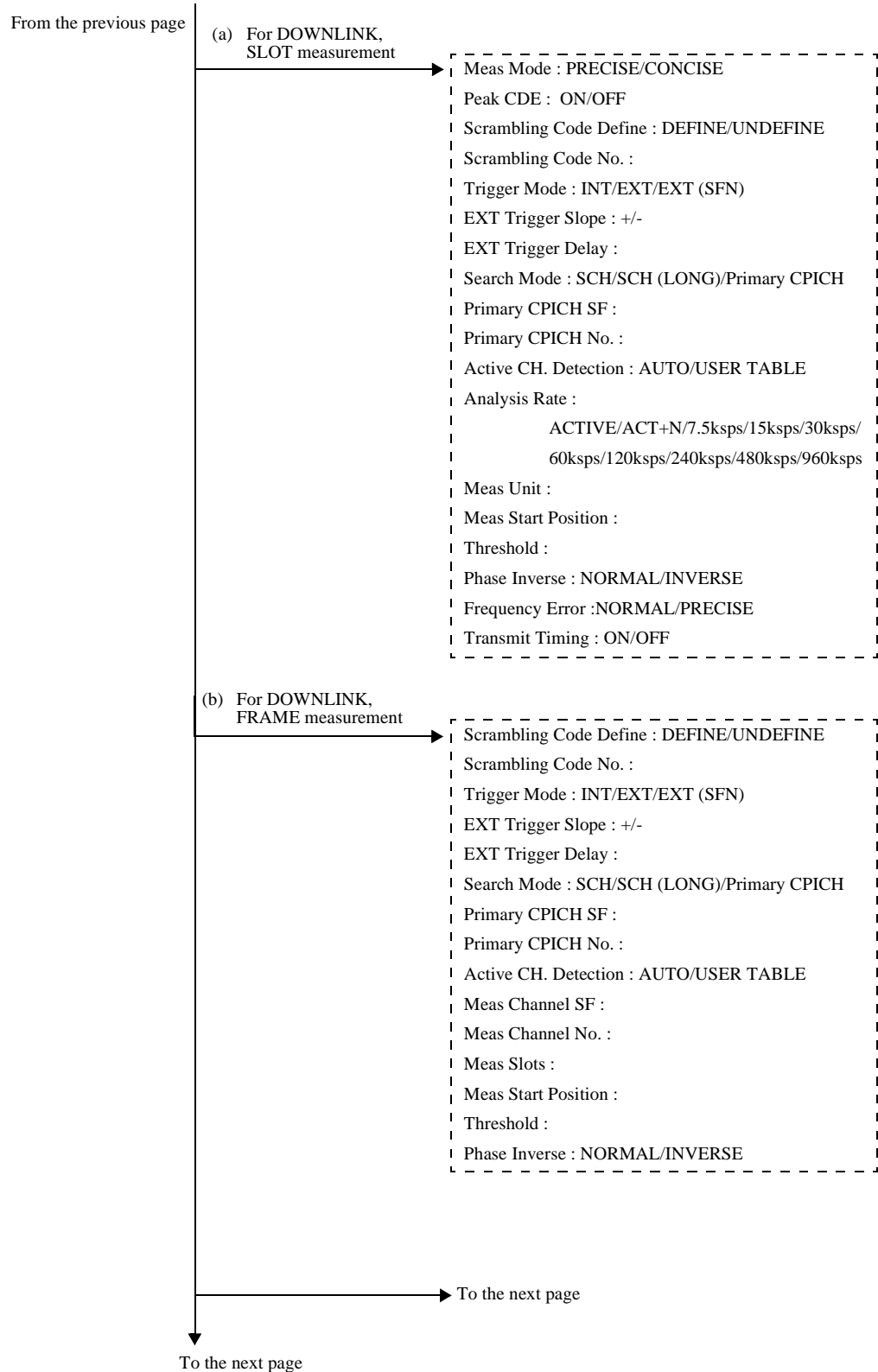

From the previous page

(c) For UPLINK,
SLOT measurement

Meas Mode : PRECISE/CONCISE
 Scrambling Code No. :
 Trigger Mode : INT/EXT
 EXT Trigger Slope : +/-
 EXT Trigger Delay :
 DPCCH SF :
 DPCCH No. :
 Analysis Rate :
 15ksps/30ksps/60ksps/120ksps
 240ksps/480ksps/960ksps
 Meas Unit :
 Meas Start Position :
 Threshold :
 Phase Inverse : NORMAL/INVERSE
 Frequency Error :NORMAL/PRECISE

(d) For UPLINK,
FRAME measurement

Scrambling Code No. :
 Trigger Mode : INT/EXT
 EXT Trigger Slope : +/-
 EXT Trigger Delay :
 DPCCH SF :
 DPCCH No. :
 Meas Channel SF :
 Meas Channel No. :
 Meas Branch : I/Q
 Meas Slots :
 Meas Start Position :
 Threshold :
 Phase Inverse : NORMAL/INVERSE

3.2 Menu Map

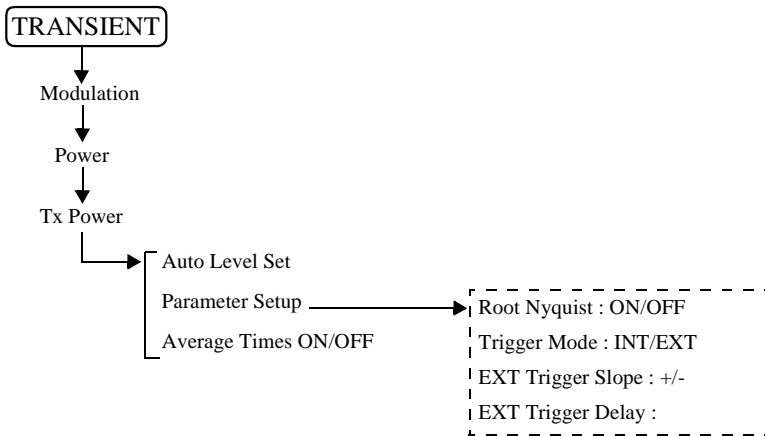
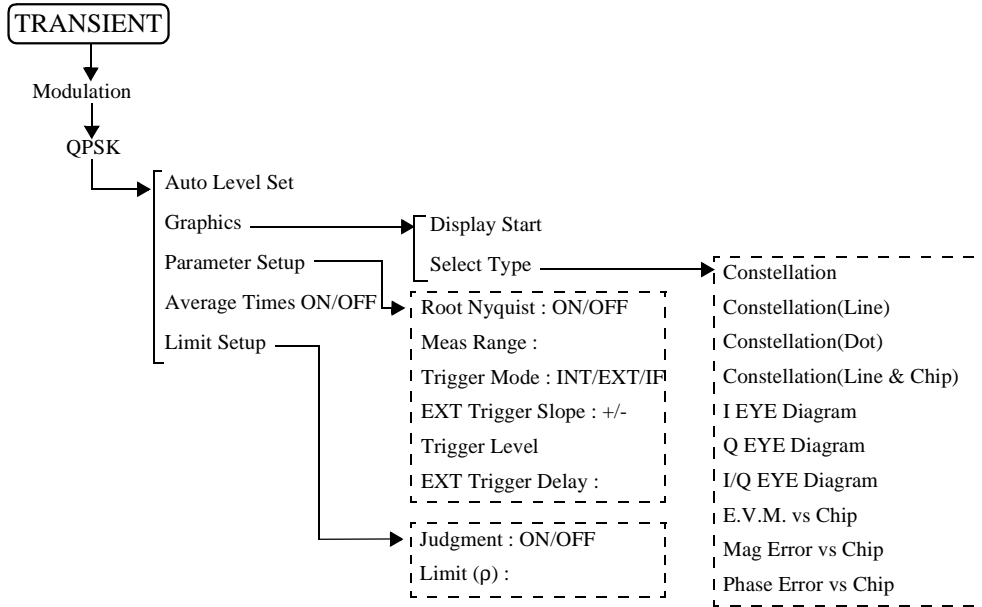

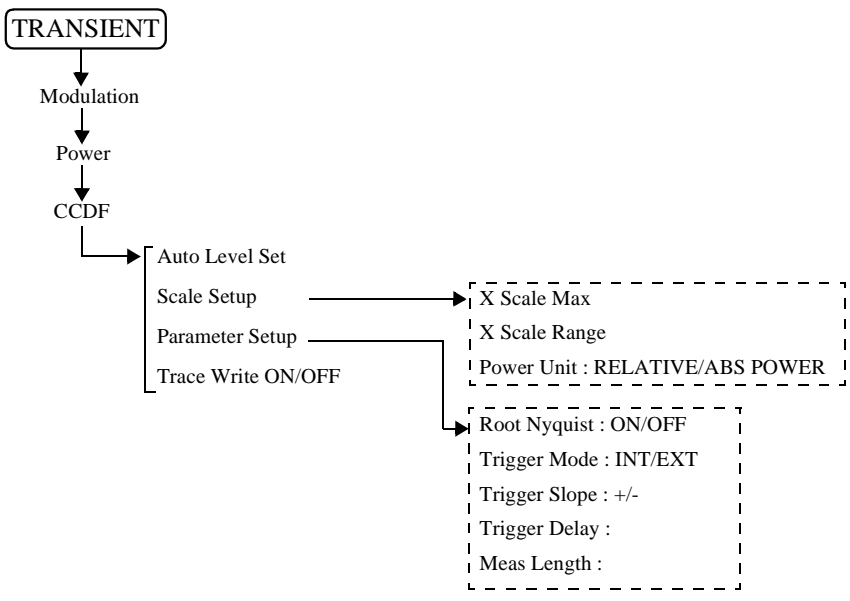
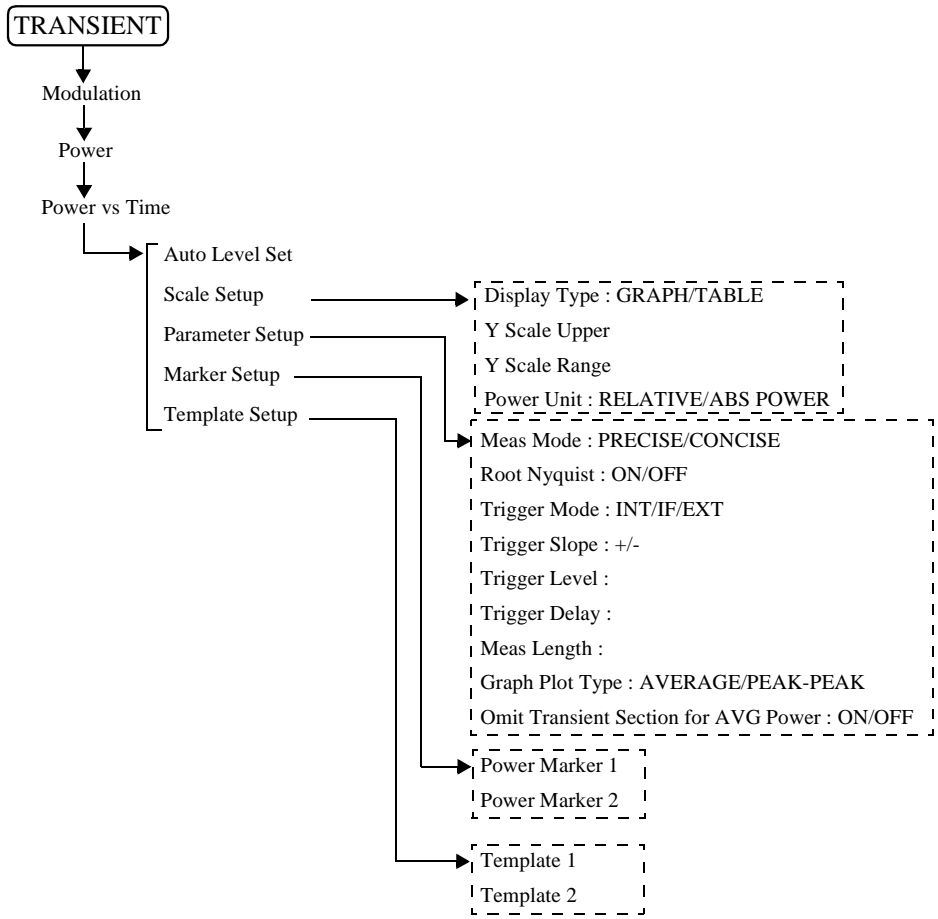

3.2 Menu Map

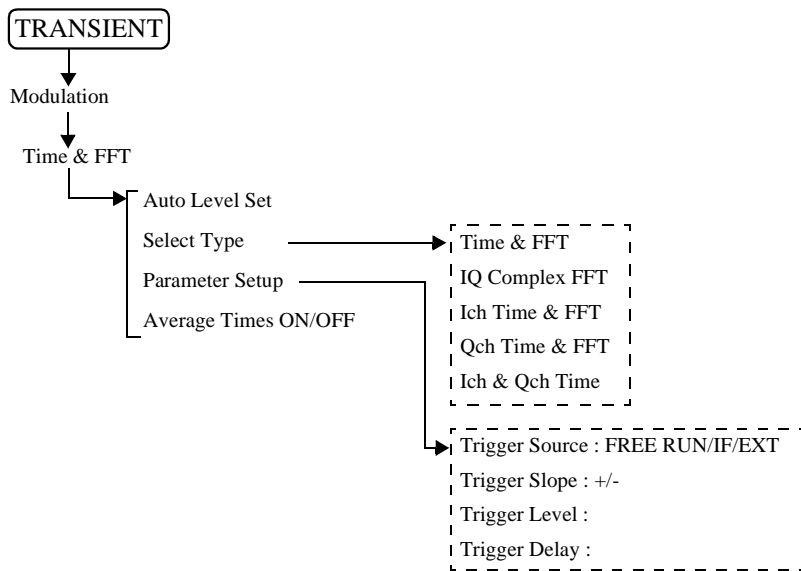
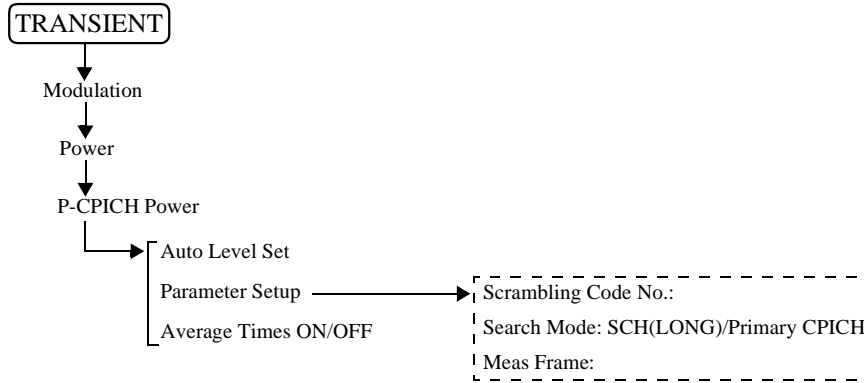

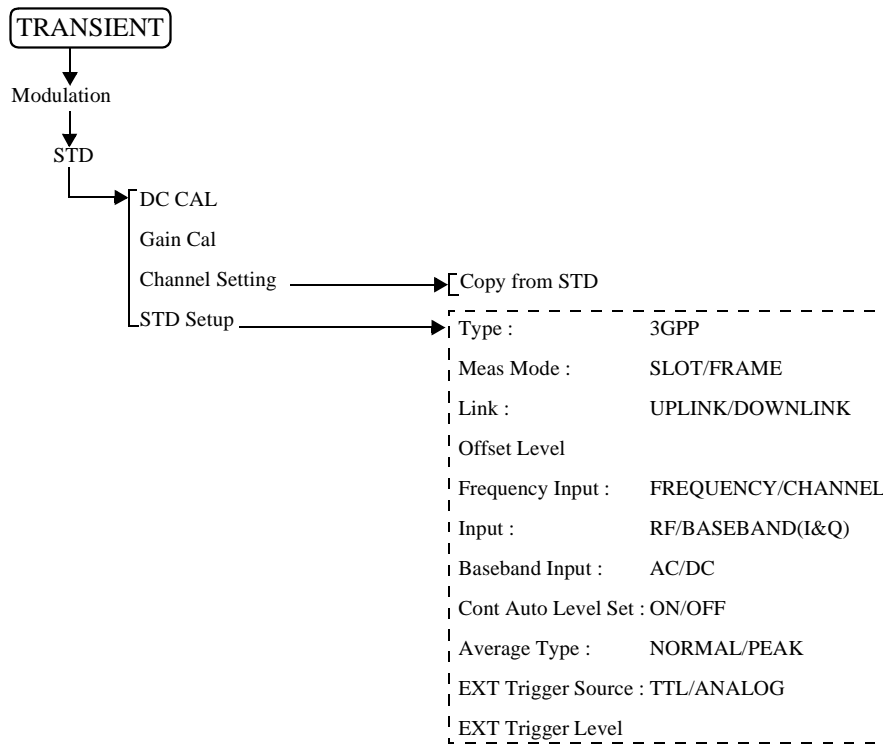

3.3 Functional Description

3.3 Functional Description

When modulation analysis hardware and software are installed, the following menus are assigned to the **TRANSIENT** key.

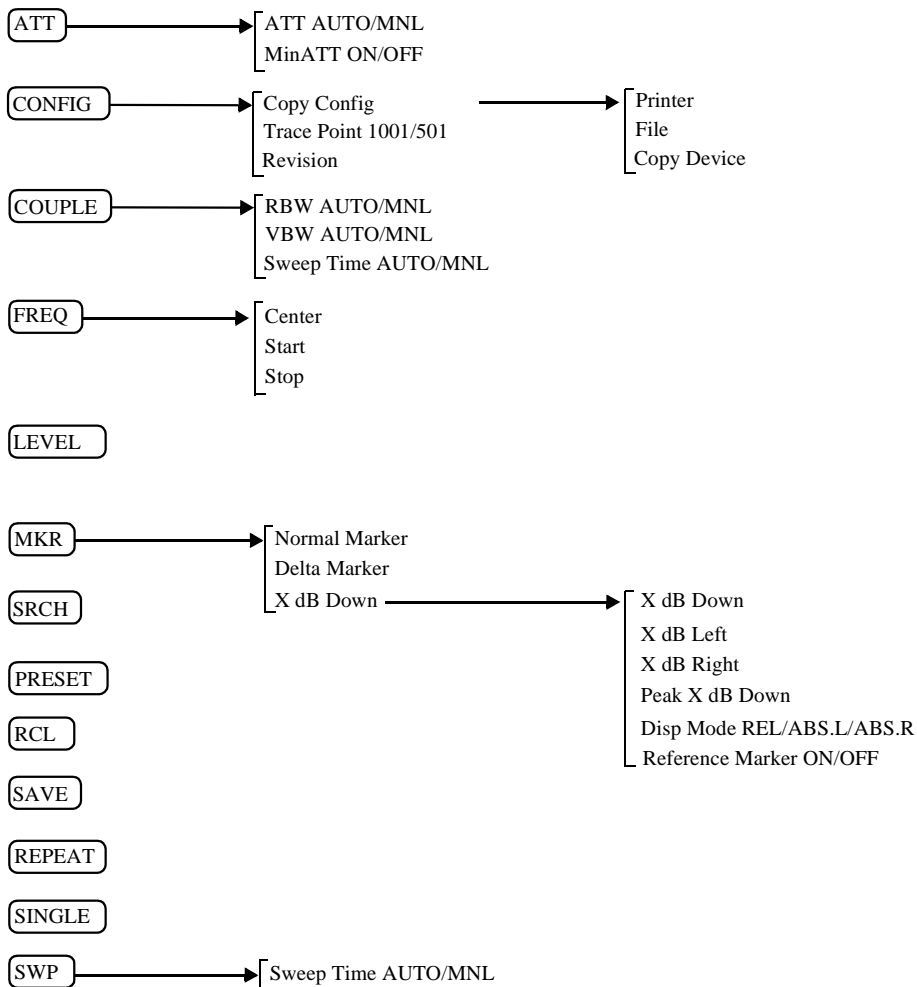

3.3.1 Switching Communication Systems

This section describes how to switch the communication systems. The analyzer must be set to the SPA mode to switch between the communication systems.

NOTE: *After the communication system has been switched, the parameters previously set for the former communication system will be cleared.
If necessary, save the old parameters, before switching the communication system to another.*

1. Press the **POWER** to enter the SPA mode.
2. Press **CONFIG**.
3. Press *more 1/2*.
If there are other communication systems installed, with which this instrument can analyze, “Comm.System” is displayed in the soft menu.
4. Press *Comm.System*.
Select the communication system you wish using the data knob, and press the knob (or **ENTR**).

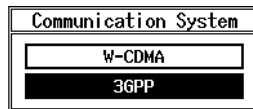

Figure 3-1 Communication Systems Dialog Box

5. When the data knob (or **ENTR**) is pressed, the message “LOADING” is displayed. After the message disappears, the switchover to another system is complete.
6. Press the **TRANSIENT** to confirm that the menu has been changed.

Saving set conditions

1. To save the parameters, press **SHIFT** and **RCL**.
2. Set the SAVE FILE number and press *Save*.

3.3 Functional Description

3.3.2 T-Domain

Carries out a measurement according to the standard using the zero span of the spectrum analyzer. Measurement items include power, ON/OFF ratio of a burst signal, and spurious measurements in the time domain with a specified frequency.

In the T-Domain measurement, the setting for the RBW, VBW, Sweep Time, or Detector is saved when exiting from each measurement and recalled when entering each measurement again. To return the setting to the value specified by the standard, press *Config* and *Set to STD*.

3.3.2.1 Power (T-Domain)

This is a function to measure power in the time domain (zero span).

There are two Pass/Fail judgment functions: a judgment function for the template and a judgment function for power.

NOTE: The RBW must be set wider than the modulation band.

Auto Level Set

Sets the internal reference level to an optimum value in accordance with the measurement signal. The reference level is automatically adjusted when this key is pressed.

NOTE: The input signal level must be constant while *Auto Level Set* is being carried out.

Trigger Setup

Sets a trigger.

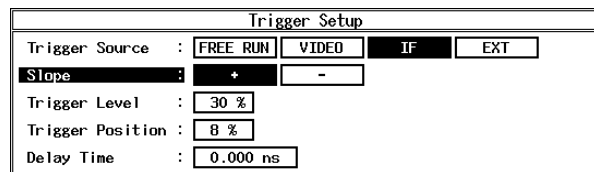

Figure 3-2 Trigger Setup Dialog Box

Trigger Source

Selects a trigger.

FREE RUN:

Captures data using the internal measurement timing.

VIDEO: Captures the signal in sync with the VIDEO signal.

IF: Captures the signal in sync with the IF signal (the leading edge of the burst).

EXT: Captures the signal in sync with the external trigger signal.

<i>Slope</i>	Selects the edge when triggering. +: Triggers at the leading edge. -: Triggers at the trailing edge.
<i>Trigger Level</i>	Sets the level to trigger.
<i>Trigger Position</i>	Sets the trigger position where it is displayed on the screen.
<i>Delay Time</i>	Sets a delay time from the time a trigger signal is detected to the time the signal is captured.
<hr/> <i>NOTE: When Delay Time is a negative value, signals before the trigger can be captured.</i> <hr/>	
<i>Window Setup</i>	Sets the window used for power measurement.
<i>Window ON/OFF</i>	Displays a window showing the range for power measurement. When OFF is set, the power measurement range covers all points on the display screen.
<i>Set to STD</i>	Sets the window specified by the communication standard.
<i>Window Position</i>	Sets the position of the window.
<i>Window Width</i>	Sets the width of the window.
<hr/> <i>NOTE: When the window is partially outside the display, an arrow is shown next to Pose, Width or both in the area indicating the window conditions.</i> <hr/>	
<i>Template</i>	Sets the template. For more information, refer to Section 5.1.1, "Template Setting in the T-Domain Measuring Mode."
<i>Template ON/OFF</i>	Sets whether to display the template and to toggles the Pass/Fail judgment function on or off.
<i>Shift X</i>	Sets the amount of template movement in the X-axis direction.
<i>Shift Y</i>	Sets the amount of template movement in the Y-axis direction.
<i>Template Edit</i>	Edits the template.
<i>Template UP/LOW</i>	Selects the upper template or the lower template.
<i>Insert Line</i>	Inserts a line.

3.3 Functional Description

<i>Delete Line</i>	Deletes a line.
<i>Sort</i>	Sorts template data in ascending order.
<i>Table Init</i>	Initializes the table.
<i>Y Scale [dB/div] 10/5/2</i>	Switches the display screen scale to 10, 5 or 2 dB/div.
<i>Average Times ON/OFF</i>	Sets the averaging count. For the method of average processing, refer to "Average Mode" in the Config → Parameter Setup.
<i>Config</i>	
<i>Parameter Setup</i>	Sets the method of measurement, edits the template, and so forth.

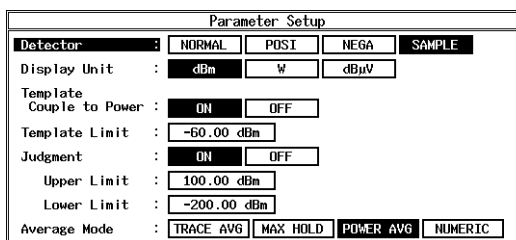

Figure 3-3 Parameter Setup Dialog Box

<i>Detector</i>	NORMAL/POSI/NEGA/SAMPLE Sets the detector.
<i>Display Unit</i>	dBm/W/dBµV Sets the display unit of power.
<i>Template Couple to Power</i>	Displays the template that is connected to the measured power. ON: Displays the template that is connected to the measured power. On the template edit screen, set the template level to the portion linked with the power value set to 0 dB. OFF: Displays the template regarding the Y-axis value edited by the template as an absolute value.
<i>Template Limit</i>	If the absolute value of the template is smaller than this value when Template Couple to Power is set to ON, clip the template at this value.
<i>Judgment</i>	Sets ON/OFF for Pass/Fail judgments.

<i>Upper Limit</i>	Sets the upper limit value of power.
<i>Lower Limit</i>	Sets the lower limit value of power.
<i>Average Mode</i>	<p>Selects the processing method when Average Times is set to ON.</p> <p>TRACE AVG: Calculates arithmetic average of the measured data (Log data) in the mode LOG.</p> <p>MAX HOLD: Displays the maximum value within the average counts of the swept waveforms.</p> <p>POWER AVG: Converts the measured data (Log data) to the linear data to take the root mean square value.</p> <p>NUMERIC: Converts the measured data (Log data) to the linear data to take the root mean square value. Using POWER AVG displays the average waveforms, using NUMERIC displays the swept waveforms and takes an average of the measurement results only.</p>
<i>Set to STD</i>	Returns measurement parameters to the values specified by the communication standard.

3.3.2.2 ON/OFF Ratio

Measures the power during the burst-on period and the one during the burst-off period, and calculate the ratio of the powers.

Captures the signal with a trigger and calculates the ratio in reference to the burst on and burst off periods (the former is defined as the period immediately before the trigger point; the latter, immediately after the trigger point).

Auto Level Set

Sets the internal reference level to an optimum value in accordance with the measurement signal. The reference level is automatically adjusted when this key is pressed.

NOTE: The signal level must remain constant while Auto Level Set is being carried out.

Trigger Setup

Sets a trigger.

Trigger Setup	
Trigger Source :	<input type="radio"/> FREE RUN <input checked="" type="radio"/> VIDEO <input type="radio"/> IF <input type="radio"/> EXT
Slope :	<input checked="" type="radio"/> + <input type="radio"/> -
Trigger Level :	<input type="text" value="30 %"/>
Trigger Position :	<input type="text" value="8 %"/>
Delay Time :	<input type="text" value="0.000 ns"/>

Figure 3-4 Trigger Setup Dialog Box

3.3 Functional Description

<i>Trigger Source</i>	<p>Selects a trigger</p> <p>FREE RUN: Captures data using the internal measurement timing.</p> <p>VIDEO: Captures the signal in sync with the VIDEO signal.</p> <p>IF: Captures the signal in sync with the IF signal (the leading edge of the burst).</p> <p>EXT: Captures the signal in sync with the external trigger signal.</p>
<i>Slope</i>	<p>Selects the edge when triggering.</p> <p>+: Triggers at the leading edge.</p> <p>-: Triggers at the trailing edge.</p>
<i>Trigger Level</i>	<p>Sets the level to trigger.</p>
<i>Trigger Position</i>	<p>Sets where the trigger position is displayed on the screen.</p>
<i>Delay Time</i>	<p>Sets a delay time from the time a trigger signal is detected to the time the signal is captured.</p> <hr/> <p>NOTE: When Delay Time is a negative value, signals before the trigger can be captured.</p> <hr/>
<i>Window Setup</i>	<p>Sets the burst ON and OFF periods.</p>
<i>Window ON/OFF</i>	<p>Displays a window showing the range for power measurement.</p>
<i>Set to STD</i>	<p>Sets the value that is specified by or complies with the communication standard.</p>
<i>ON Position</i>	<p>Sets the desired position during the burst-on period.</p>
<i>ON Width</i>	<p>Sets the desired width during the burst-on period.</p>
<i>OFF Position</i>	<p>Sets the position during the burst-off period.</p>
<i>OFF Width</i>	<p>Sets the width during the burst-off period.</p> <hr/> <p>NOTE: When the window is partially outside the display, an arrow is shown next to Pose, Width or both in the area indicating the window conditions.</p> <hr/>
<i>Y Scale [dB/div] 10/5/2</i>	<p>Selects the display screen scale to 10, 5 or 2 dB/div.</p>

Average Times ON/OFF

Sets the averaging count.

For the method of average processing, refer to "Average Mode" in the Config → Parameter Setup.

Config**Parameter Setup**

Sets measurement parameters and so on.

Parameter Setup			
Detector	NORMAL	POSI	NEGA SAMPLE
Display Unit	dBm	W	dBμV
Judgment	ON	OFF	
Upper Limit	-100.00 dB		
Average Mode	TRACE AVG	MAX HOLD	POWER AVG NUMERIC

Figure 3-5 Parameter Setup Dialog Box

Detector

NORMAL/POSI/NEGA/SAMPLE

Selects the detector.

Display Unit

dBm/W/dBμV

Sets the display unit of power.

NOTE: The ON/OFF ratio is displayed in units of dB (fixed).

Judgment

Sets ON/OFF of the Pass/Fail judgment for the ON/OFF ratio.

Upper Limit

Enters the upper limit value.

Average Mode

Selects the processing method when Average Times is set to ON.

TRACE AVG:

Calculates arithmetic average of the measured data (Log data) in the mode LOG.

MAX HOLD:

Displays the maximum value within the average counts of the swept waveforms.

POWER AVG:

Converts the measured data (Log data) to the linear data to take the root mean square value.

NUMERIC:

Converts the measured data (Log data) to the linear data to take the root mean square value.

Using POWER AVG displays the average waveforms, using NUMERIC displays the swept waveforms and takes an average of the measurement results only.

Set to STD

Sets measurement parameters to the values specified by the communication standard.

3.3 Functional Description

3.3.2.3 Spurious (T-Domain)

This is a function to measure power (or peak power) according to the frequency specified in the table by sweeping in the zero span mode.

Auto Level Set

Sets the internal reference level to an optimum value in accordance with the measurement signal. The reference level is automatically adjusted when this key is pressed.

NOTE: The signal level must be constant while Auto Level Set is being carried out.

Trigger Setup

Sets a trigger.

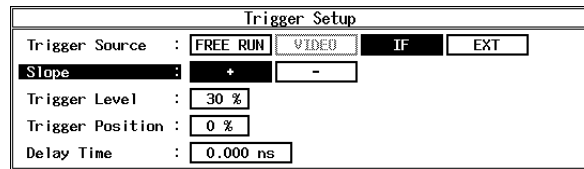

Figure 3-6 Trigger Setup Dialog Box

Trigger Source

Selects a trigger

FREE RUN:

Captures data using the internal measurement timing.

IF: Captures the signal in sync with the IF signal (the leading edge of the burst).

EXT: Captures the signal in sync with the external trigger signal.

Slope

Selects the edge when triggering.

+: Triggers at the leading edge.

-: Triggers at the trailing edge.

Trigger Level

Sets the level to trigger.

Trigger Position

Sets where the trigger position is displayed on the screen.

Delay Time

Sets a delay time from the time a trigger signal is detected to the time the signal is captured.

NOTE: When Delay Time is a negative value, signals before the trigger can be captured.

Table No. 1/2/3

Selects the measurement table.

Load Table	Loads the measurement table.
Table Edit	Edits the measurement table.
Table No. 1/2/3	Selects the table to be edited.
Load Table	Loads the measurement table.
Save Table	Saves the measurement table.
Insert Line	Inserts additional frequency data before the selected frequency number.
Delete Line	Deletes the selected line.
Table Init	Initializes the table
Average Times ON/OFF	Sets the averaging count. For the method of average processing, refer to "Average Mode" in the Config → Parameter Setup.

Config**Parameter Setup**

Sets measurement conditions and so on.

Figure 3-7 Parameter Setup Dialog Box

Detector	NORMAL/POSI/NEGA/SAMPLE Sets the detector.
Result	PEAK/RMS Sets whether to display the result using average power or peak power.
Peak MKR Y Delta	Sets the Y delta of the peak marker.
Multiplier	Multiplies the measurement result by the set value, then displays the resultant value.
Display Unit	dBm/W/dBuV Sets the display units.

3.3 Functional Description

Judgment Sets ON/OFF of the Pass/Fail judgment for the limit value.

Preselector Sets the preselector.

NOTE: This menu is displayed on R3267 only.

1.6G: Used to measure harmonics of more than 1.6 GHz or spurious signals when the carrier frequency is lower than 1.6 GHz.

3.6G: Used to set this parameter for cases other than that above.

Average Mode Selects the processing method when Average Times is set to ON.

TRACE AVG:

Calculates arithmetic average of the measured data (Log data) in the mode LOG.

MAX HOLD:

Displays the maximum value within the average counts of the swept waveforms.

POWER AVG:

Converts the measured data (Log data) to the linear data to take the root mean square value.

NUMERIC:

Converts the measured data (Log data) to the linear data to take the root mean square value.

Using POWER AVG displays the average waveforms, using NUMERIC displays the swept waveforms and takes an average of the measurement results only.

Set to Default Returns the set value to the default.

3.3.3 F-Domain

Carries out a measurement according to the communication standard using the spectrum analyzer's sweep measurement method. Measurement items include power, occupied bandwidth, ACP Due To Transient, ACP Due to Modulation, Inband Spurious, and Outband Spurious measurements in the frequency domain.

In F-Domain measurement, the setting for the RBW, VBW, Sweep Time, or Detector is saved when exiting each measurement and recalled when entering each measurement again. To return the setting to the value specified by the standard, press *Config* and *Set to STD*.

3.3.3.1 Power (F-Domain)

This is a function to measure power in the frequency domain using the spectrum analyzer.

Auto Level Set

Sets the internal reference level to an optimum value in accordance with the measurement signal. The reference level is automatically adjusted when this key is pressed.

NOTE: *The signal level must be constant while Auto Level Set is being carried out.*

Gate Setup

Sets the gated sweep.

This setting is required when the input signal is a bursted signal and Sample Detector is used.

Trigger Setup

Sets a trigger.

Trigger Setup	
Trigger Source :	FREE RUN VIDEO IF EXT
Slope :	+ -
Trigger Level :	30 %
Trigger Position :	8 %
Delay Time :	0.000 ns

Figure 3-8 Trigger Setup Dialog Box

Trigger Source

Selects a trigger

FREE RUN:

Captures data using the internal measurement timing.

VIDEO: Captures the signal in sync with the VIDEO signal.

IF: Captures the signal in sync with the IF signal (the leading edge of the burst).

EXT: Captures the signal in sync with the external trigger signal.

Slope

Selects the edge when triggering.

+: Triggers at the leading edge.

-: Triggers at the trailing edge.

3.3 Functional Description

- Trigger Level** Sets the level to trigger.
- Trigger Position** Sets where the trigger position is displayed on the screen.
- Delay Time** Sets a delay time from the time a trigger signal is detected to the time the signal is captured.

NOTE: When Delay Time is a negative value, signals before the trigger can be captured.

Gate Source

- Trigger** Sets Trigger Source specified by Trigger Setup as Gate Source.

NOTE: When Trigger Source is set to IF and SPAN is set to a frequency higher than 6 MHz, the sweeping seems to be stopped, because the IF trigger bandwidth is approximately 6 MHz and the gate trigger is failing.

- Ext Gate** Sets the gated sweep mode using the gate signal input from the EXT GATE terminal on the rear panel.

- Gate Setup** Sets the gated sweep range when Trigger is selected for Gate Source.

- Set to STD** Sets the gate position and width to the values specified by the communication standard.

- Gate Position** Sets the gate position.

- Gate Width** Sets the gate width.

- Gated Sweep ON/OFF** Starts the gated sweep.

- Detector** NORMAL/POSI/NEGA/SAMPLE
Selects the detector.

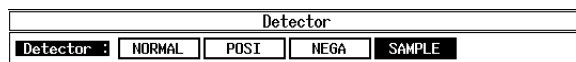

Figure 3-9 Detector Dialog Box

Window Setup	Sets the frequency range used for power measurement.
Window ON/OFF	Sets the window to ON or OFF. When the window is set to OFF, the power measurement range becomes a sweep band.
Set to STD	Sets the value determined by the communication standard.
Window Position	Sets the position of the window.
Window Width	Sets the width of the window.

NOTE: When the window is partially outside the display, an arrow is shown next to Pose, Width or both in the area indicating the window conditions.

Y Scale [dB/div] 10/5/2	Sets the display scale.
Average Times ON/OFF	Sets the averaging count. For the method of average processing, refer to "Average Mode" in the Config → Parameter Setup.

Config

Parameter Setup Sets measurement conditions and so on.

Figure 3-10 Parameter Setup Dialog Box

Detector	NORMAL/POSTI/NEGA/SAMPLE Selects the detector.
Gated Sweep	Sets the gated sweep to ON or OFF.
Display Unit	dBm/W/dB μ V Selects the display unit.
Judgment	Sets ON/OFF of the Pass/Fail judgment for measured power.
Upper Limit	Sets the upper limit for Pass/Fail judgment.
Lower Limit	Sets the lower limit for Pass/Fail judgment.

3.3 Functional Description

<i>Average Mode</i>	<p>Selects the processing method when Average Times is set to ON.</p> <p>TRACE AVG: Calculates arithmetic average of the measured data (Log data) in the mode LOG.</p> <p>MAX HOLD: Displays the maximum value within the average counts of the swept waveforms.</p> <p>POWER AVG: Converts the measured data (Log data) to the linear data to take the root mean square value.</p> <p>NUMERIC: Converts the measured data (Log data) to the linear data to take the root mean square value. Using POWER AVG displays the average waveforms, using NUMERIC displays the swept waveforms and takes an average of the measurement results only.</p>
<i>Set to STD</i>	<p>Sets the measurement parameters to the values specified by the communication standard.</p>

3.3.3.2 OBW

Measure an occupied bandwidth.

<i>Auto Level Set</i>	<p>Sets the internal reference level to an optimum value in accordance with the measurement signal. The reference level is automatically adjusted when this key is pressed.</p>
------------------------------	---

NOTE: The signal level must be constant while Auto Level Set is being carried out.

<i>OBW%</i>	<p>Sets the frequency, including the percentage of the total power as an occupied bandwidth, when calculating the occupied bandwidth.</p>
--------------------	---

<i>Average Times ON/OFF</i>	<p>Sets the averaging count. For the method of average processing, refer to "Average Mode" in the Config → Parameter Setup.</p>
------------------------------------	---

Config

Parameter Setup

Sets measurement conditions and so on.

Parameter Setup			
Detector :	<input type="radio"/> NORMAL	<input type="radio"/> POSI	<input type="radio"/> NEGA <input checked="" type="radio"/> SAMPLE
Judgment :	<input checked="" type="radio"/> ON	<input type="radio"/> OFF	
Upper Limit :	<input type="text" value="2.50 MHz"/>		
Lower Limit :	<input type="text" value="750 kHz"/>		
Average Mode :	<input checked="" type="radio"/> TRACE AVG	<input type="radio"/> MAX HOLD	<input type="radio"/> POWER AVG <input type="radio"/> NUMERIC

Figure 3-11 Parameter Setup Dialog Box

Detector

NORMAL/POSI/NEGA/SAMPLE

Selects the detector.

Judgment

Sets ON/OFF of the Pass/Fail judgment for the occupied bandwidth.

Upper Limit

Sets the upper limit for Pass/Fail judgment.

Lower Limit

Sets the lower limit for Pass/Fail judgment.

Average Mode

Selects the processing method when Average Times is set to ON.

TRACE AVG:

Calculates OBW based on the waveforms, which were generated as a result of arithmetic average of the measured data (Log data) in the log mode.

MAX HOLD:

Calculates OBW based on the waveform with the maximum value within the average counts of the measured data.

POWER AVG:

Calculates OBW based on the waveforms, which were calculated as a result of the conversion of the measured data (Log data) to the linear data to take the room mean square.

NUMERIC:

Calculates OBW by sweep and calculates arithmetic average to display the result. The displayed waveforms are not averaged.

Set to STD

Sets the measurement parameters to the values specified by the communication standard.

3.3 Functional Description

3.3.3.3 Due to Transient

This is a function to measure the spectrum, including the rise and fall times of the burst.

Auto Level Set

Sets the internal reference level to an optimum value in accordance with the measurement signal. The reference level is automatically adjusted when this key is pressed.

NOTE: The signal level must be constant while Auto Level Set is being carried out.

Template

Sets and edits the template.

For more information, refer to Section 5.1.2, "Template Setting in the F-Domain Measuring Mode."

Template ON/OFF

Sets ON/OFF of the template display.

When Template is set to ON, the Pass/Fail judgment for the template is displayed under the sweep screen.

Shift X

Shifts the set template in the frequency direction (X-axis).

Shift Y

Shifts the set template in the level direction (Y-axis).

Margin ΔX ON/OFF

Magnifies the template in the X-axis direction with a set template frequency 0 as the center.

Template Edit

Opens the template edit menu.

Insert Line

Inserts a line before the selected line.

Delete Line

Deletes the selected line.

Sort

Sorts the tables in order of frequency.

Table Init

Initializes the table.

Marker Edit

Sets the measurement frequency (frequency offset) and measurement band.

For more information, refer to Section 5.2.1, "Marker Edit Function."

Copy from STD

Sets to the parameters specified by the communication standard.

Insert Line

Inserts a line before the selected line.

Delete Line

Deletes the selected line.

Sort

Sorts data in order of frequency.

Table Init	Initializes the table.
Average Times ON/OFF	Sets the averaging count. For the method of average processing, refer to "Average Mode" in the Config → Parameter Setup.
Config	
Parameter Setup	Sets measurement conditions and so on.

Figure 3-12 Parameter Setup Dialog Box

Freq. Setting	START&STOP/SPAN Selects the measurement mode.
Detector	NORMAL/POSI/NEGA/SAMPLE Selects the detector.
Result	Specifies how to display the result. For more information, refer to Section 5.2.2, "Measurement results Using Due to Modulation, Due to Transient and Inband Spurious Modes." MARKER: Displays the marker read value. The position of the marker is set by Marker Edit. RELATIVE: Displays the marker read value using a relative value. ABS POWER: Converts the value displayed by RELATIVE into the absolute value using carrier power and displays it.
Ref Power	When RELATIVE is selected for Result, this selects which relative value to use to display the marker read value. REF MARKER: Displays a relative value to Ref Marker set by Marker Edit. MODULATION: Displays a relative value to the measurement result of Tx power in Modulation.

3.3 Functional Description

Display Unit dBm/W/dBμV
 Specifies the unit of the result displayed.

NOTE: When RELATIVE is selected for Result, the unit is dB.

Template Couple to Power
 Sets whether to raise or lower the template with the power set by Ref Power.

Template Limit If the absolute value of the template is smaller than this value when Template Couple to Power is set to ON, clip the template at this value.

Judgment Used to make the Pass/fail judgment for the limit value set by Marker edit. The Pass/Fail judgment result is displayed under the display screen together with the marker list.

Symbol Rate 1/T Sets the symbol rate of the Root Nyquist filter.

Rolloff Factor Sets the roll-off of the Root Nyquist filter.

Average Mode Selects the processing method when Average Times is set to ON.

TRACE AVG:
 Calculates arithmetic average of the measured data (Log data) in the mode LOG.

MAX HOLD:
 Displays the maximum value within the average counts of the swept waveforms.

POWER AVG:
 Converts the measured data (Log data) to the linear data to take the root mean square value.

NUMERIC:
 Converts the measured data (Log data) to the linear data to take the root mean square value.
 Using POWER AVG displays the average waveforms, using NUMERIC displays the swept waveforms and takes an average of the measurement results only.

Set to STD Returns the measurement parameters to the values specified by the standard.

3.3.3.4 Due to Modulation

Measure the modulation spectrum excluding the rise and fall of the burst.

Auto Level Set

Sets the internal reference level to an optimum value in accordance with the measurement signal. The reference level is automatically adjusted when this key is pressed.

NOTE: *The signal level must be constant while Auto Level Set is being carried out.*

Gate Setup

Sets the gated sweep.

Trigger Setup

Sets a trigger.

Trigger Setup	
Trigger Source :	FREE RUN VIDEO IF EXT
Slope :	+ -
Trigger Level :	30 %
Trigger Position :	8 %
Delay Time :	0.000 ns

Figure 3-13 Trigger Setup Dialog Box

Trigger Source

Selects a trigger.

FREE RUN:

Captures data using the internal measurement timing.

VIDEO: Captures the signal in sync with the VIDEO signal.

IF: Captures the signal in sync with the IF signal (the leading edge of the burst).

EXT: Captures the signal in sync with the external trigger signal.

Slope

Selects the edge when triggering.

+: Triggers at the leading edge.

-: Triggers at the trailing edge.

Trigger Level

Sets the level to trigger.

Trigger Position

Sets where the trigger position is displayed on the screen.

Delay Time

Sets a delay time from the time a trigger signal is detected to the time the signal is captured.

NOTE: *When Delay Time is a negative value, signals before the trigger can be captured.*

3.3 Functional Description

Gate Source

Trigger Sets Trigger Source specified by Trigger Setup as Gate Source.

NOTE: When *Trigger Source* is set to *IF* and *SPAN* is set to a frequency higher than 6 MHz, the sweeping seems to be stopped, because the *IF* trigger bandwidth is approximately 6 MHz and the gate trigger is failing.

Ext Gate Performs the gated sweep using the gate signal input from the EXT Gate terminal on the rear panel.

Gate Setup Sets the gated sweep range when Trigger is selected for Gate Source.

Set to STD Sets the gate position and width to the values specified by the communication standard.

Gate Position Sets the gate position.

Gate Width Sets the gate width.

Gated Sweep ON/OFF Starts the gated sweep.

Detector NORMAL/POSI/NEGA/SAMPLE
Selects the detector.

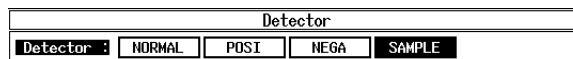

Figure 3-14 Detector Dialog Box

Template Sets and edits the template.
For more information, refer to Section 5.1.2, "Template Setting in the F-Domain Measuring Mode."

Template ON/OFF Sets the template display to ON or OFF.
When Template is set to ON, the Pass/Fail judgment for the template is displayed under the sweep screen.

Shift X Shifts the set template in the frequency direction (X-axis).

Shift Y Shifts the set template in the level direction (Y-axis).

Margin ΔX ON/OFF Magnifies the template in the X-axis direction with a set template frequency 0 as the center.

Template Edit

<i>Insert Line</i>	Inserts a line before the selected line.
<i>Delete Line</i>	Deletes the selected line.
<i>Sort</i>	Sorts the tables in frequency order.
<i>Table Init</i>	Initializes the table.
<i>Marker Edit</i>	For more information, refer to Section 5.2.1, "Marker Edit Function."
<i>Copy from STD</i>	Sets to the parameters specified by the communication standard.
<i>Insert Line</i>	Inserts a line before the selected line.
<i>Delete Line</i>	Deletes the selected line.
<i>Sort</i>	Sorts data in order of frequency.
<i>Table Init</i>	Initializes the table.
<i>Average Times ON/OFF</i>	Sets the averaging count. For the method of average processing, refer to "Average Mode" in the Config → Parameter Setup.
<i>Config</i>	
<i>Parameter Setup</i>	Sets measurement conditions and so on.

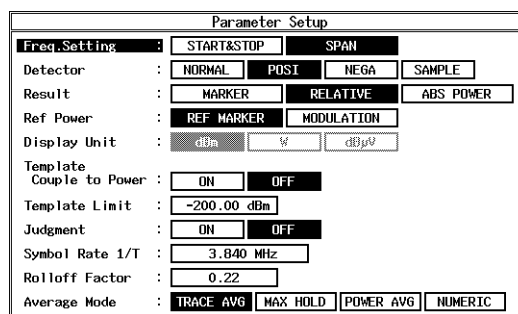

Figure 3-15 Parameter Setup Dialog Box

<i>Freq. Setting</i>	START&STOP/SPAN Selects the measurement mode.
<i>Detector</i>	NORMAL/POSI/NEGA/SAMPLE Selects the detector.

3.3 Functional Description

Result Specifies how to display the results.
 For more information, refer to Section 5.2.2, "Measurement results Using Due to Modulation, Due to Transient and Inband Spurious Modes."
MARKER:
 Displays the marker read value. The position of the marker is set by Marker Edit.
RELATIVE:
 Displays the marker read value using a relative value.
ABS POWER:
 Converts the value displayed by RELATIVE into the absolute value using carrier power and displays it.

Ref Power When RELATIVE is selected for Result, this selects which relative value to use to display the marker read value.
REF MARKER:
 Displays a relative value to Ref Marker set by Marker Edit.
MODULATION:
 Displays a relative value to the measurement result of Tx power in Modulation.

Display Unit dBm/W/dBμV
 Selects the display unit.

NOTE: When RELATIVE is selected for Result, the unit is dB.

Template Couple to Power Sets whether or not to raise or lower the template with the power set by Ref Power.

Template Limit If the absolute value of the template is smaller than this value when Template Couple to Power is set to ON, clip the template at this value.

Judgment Used to make the Pass/Fail judgment for the limit value set by Marker edit. The Pass/Fail judgment result is displayed under the display screen together with the marker list.

Symbol Rate 1/T Sets the symbol rate of the Root Nyquist filter.

Rolloff Factor Sets the roll-off of the Root Nyquist filter.

Average Mode Selects the processing method when Average Times is set to ON.
TRACE AVG:
 Calculates arithmetic average of the measured data (Log data) in the mode LOG.

MAX HOLD:

Displays the maximum value within the average counts of the swept waveforms.

POWER AVG:

Converts the measured data (Log data) to the linear data to take the root mean square value.

NUMERIC:

Converts the measured data (Log data) to the linear data to take the root mean square value.

Using POWER AVG displays the average waveforms, using NUMERIC displays the swept waveforms and takes an average of the measurement results only.

Set to STD

Returns the measurement parameters to the values specified by the standard.

3.3.3.5 Inband Spurious (1)

This is a function to search for a peak by sweeping the set frequency.

Auto Level Set

Sets the internal reference level to an optimum value in accordance with the measurement signal. The reference level is automatically adjusted when this key is pressed.

NOTE: The signal level must be constant while Auto Level Set is being carried out.

Template

For more information, refer to Section 5.1.2, "Template Setting in the F-Domain Measuring Mode."

Template ON/OFF

Sets the template display to ON or OFF. When Template is set to ON, the Pass/Fail judgment for the template is displayed under the sweep screen.

Shift X

Shifts the set template in the frequency direction (X-axis).

Shift Y

Shifts the set template in the level direction (Y-axis).

Margin ΔX ON/OFF

Magnifies the template in the X-axis direction with a set template frequency 0 as the center.

Template Edit***Copy from STD***

Copies the template specified by the communication standard.

Insert Line

Inserts a line before the selected line.

Delete Line

Deletes the selected line.

3.3 Functional Description

<i>Sort</i>	Sorts the tables in frequency order.
<i>Table Init</i>	Initializes the table.
<i>Marker Edit</i>	For more information, refer to Section 5.2.1, "Marker Edit Function."
<i>Copy from STD</i>	Sets the measurement parameters specified by the communication standard.
<i>Insert Line</i>	Inserts a line before the selected line.
<i>Delete Line</i>	Deletes the selected line.
<i>Sort</i>	Sorts data in order of frequency.
<i>Table Init</i>	Initializes the table.
<i>Average Times ON/OFF</i>	Sets the averaging count. For the method of average processing, refer to "Average Mode" in the Config → Parameter Setup.
<i>Config</i>	
<i>Parameter Setup</i>	Sets measurement conditions and so on.

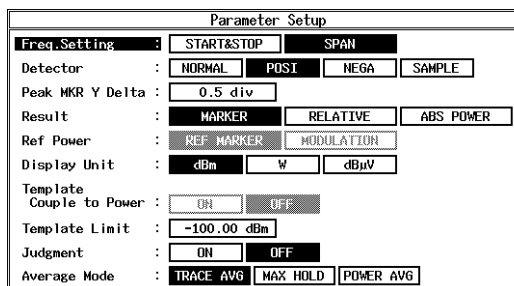

Figure 3-16 Parameter Setup Dialog Box

<i>Freq. Setting</i>	START&STOP/SPAN Selects the measurement mode.
<i>Detector</i>	NORMAL/POSTI/NEGA/SAMPLE Selects the detector.
<i>Peak MKR Y Delta</i>	Sets the Y delta of the peak marker.
<i>Result</i>	Specifies how to display the results. For more information, refer to Section 5.2.3, "Measurement Result of Inband Spurious."

	<p>MARKER: Displays the marker read value. The position of the marker is set by Marker Edit.</p> <p>RELATIVE: Displays the marker read value using a relative value.</p> <p>ABS POWER: Converts the value displayed by RELATIVE into the absolute value using carrier power and displays it.</p>
Ref Power	When RELATIVE is selected for Result, this selects which relative value is used to display the marker read value.
	<p>REF MARKER: Displays a relative value to Ref Marker set by Marker Edit.</p> <p>MODULATION: Displays a relative value to the measurement result of Tx power in Modulation.</p>
Display Unit	dBm/W/dB μ V Selects the display unit.

NOTE: When RELATIVE is selected for Result, the unit is dB.

Template Couple to Power	Sets whether or not to raise or lower the template with the power set by Ref Power.
Template Limit	If the absolute value of the template is smaller than this value when Template Couple to Power is set to ON, clip the template at this value.
Judgment	Used to make the Pass/Fail judgment for the limit value set by Marker edit. The Pass/Fail judgment result is displayed under the display screen together with the marker list.
Average Mode	<p>Selects the processing method when Average Times is set to ON.</p> <p>TRACE AVG: Calculates arithmetic average of the measured data (Log data) in the mode LOG.</p> <p>MAX HOLD: Displays the maximum value within the average counts of the swept waveforms.</p> <p>POWER AVG: Converts the measured data (Log data) to the linear data to take the root mean square value.</p>

Set to STD Returns the measurement parameters to the values specified by

3.3 Functional Description

the standard.

3.3.3.6 Inband Spurious (2)

Converts resolution bandwidth (RBW) to search spurious signal.

When the spurious is swept with broadband RBW near the career frequency, the career signal cannot be separated, which makes the spurious search impossible. In this situation, the sweep with narrow RBW is required to calculate the bandwidth in order to search spurious signal.

Auto Level Set Sets the internal reference level to an optimum value in accordance with the measurement signal. The reference level is automatically adjusted when this key is pressed.

NOTE: The signal level must be constant while Auto Level Set is being carried out.

Template For more information, refer to Section 5.1.2, "Template Setting in the F-Domain Measuring Mode."

Template ON/OFF Sets the template display to ON or OFF. When Template is set to ON, the Pass/Fail judgment for the template is displayed under the sweep screen.

Shift X Shifts the set template in the frequency direction (X-axis).

Shift Y Shifts the set template in the level direction (Y-axis).

Margin ΔX ON/OFF Magnifies the template in the X-axis direction with a set template frequency 0 as the center.

Template Edit

Copy from STD Copies the template specified by the communication standard.

Insert Line Inserts a line before the selected line.

Delete Line Deletes the selected line.

Sort Sorts the tables in frequency order.

Table Init Initializes the table.

Marker Edit For more information, refer to Section 5.2.1, "Marker Edit Function."

Copy from STD Sets the measurement parameters specified by the communication standard.

Insert Line Inserts a line before the selected line.

<i>Delete Line</i>	Deletes the selected line.
<i>Sort</i>	Sorts data in order of frequency.
<i>Table Init</i>	Initializes the table.
<i>Average Times ON/OFF</i>	Sets the averaging count.
<i>Config</i>	
<i>Parameter Setup</i>	Sets measurement conditions and so on.

Figure 3-17 Parameter Setup Dialog Box

<i>Freq. Setting</i>	START&STOP/SPAN Selects the measurement mode.
<i>Detector</i>	NORMAL/POSI/NEGA/SAMPLE Selects the detector.
<i>Peak MKR Y Delta</i>	Sets the Y delta of the peak marker.
<i>Result</i>	Specifies how to display the results. For more information, refer to Section 5.2.3, "Measurement Result of Inband Spurious." MARKER: Displays the marker read value. The position of the marker is set by Marker Edit. RELATIVE: Displays the marker read value using a relative value. ABS POWER: Converts the value displayed by RELATIVE into the absolute value using carrier power and displays it.
<i>Ref Power</i>	When RELATIVE is selected for Result, this selects which relative value is used to display the marker read value.

3.3 Functional Description

REF MARKER:

Displays a relative value to Ref Marker set by Marker Edit.

MODULATION:

Displays a relative value to the measurement result of Tx power in Modulation.

Display Unit dBm/W/dB μ V
Selects the display unit.

NOTE: When *RELATIVE* is selected for Result, the unit is dB.

Template Couple to Power

Sets whether or not to raise or lower the template with the power set by Ref Power.

Template Limit

If the absolute value of the template is smaller than this value when Template Couple to Power is set to ON, clip the template at this value.

Judgment

Used to make the Pass/Fail judgment for the limit value set by Marker edit. The Pass/Fail judgment result is displayed under the display screen together with the marker list.

Band Conversion

This function is used to calculate the resolution bandwidth using the swept waveforms.

ON: Calculates resolution bandwidth using the measured data.

OFF: Does not calculate resolution bandwidth using the measured data.

Integral Band

Sets resolution bandwidth that conducts the bandwidth calculation.

Start Offset

Sets the starting frequency that conducts the bandwidth calculation, using the offset frequency from the center frequency.

Stop Offset

Sets the ending frequency that conducts the band calculation, using the offset frequency from the center frequency.

NOTE: Even when the Start Offset and Stop Offset values have been set beyond the frequency display range, data is calculated within the frequency display range.

Average Mode

Sets the processing when Average Times is set to ON. POWER AVG is fixed.

POWER AVG:

Converts the measured data (Log data) to the linear data to take the root mean square

Set to STD

Returns the measurement parameters to the values specified by the standard.

3.3.3.7 Outband Spurious

This is a function to search for a peak by sweeping the frequency according to the table.

Auto Level Set

Sets the internal reference level to an optimum value in accordance with the measurement signal. The reference level is automatically adjusted when this key is pressed.

NOTE: The signal level must be constant while Auto Level Set is being carried out.

Table No. 1/2/3

Selects the table number.

Load Table

Loads the table.

Table Edit

Edits the table.

Copy from STD

Sets the measurement parameters to the communication standard.

Table No. 1/2/3

Selects the table number.

Load Table

Loads the table.

Save Table

Saves the table.

Insert Line

Inserts a line before the selected line.

Delete Line

Deletes the selected line.

Table Init

Initializes the table

Average Times ON/OFF

Sets the averaging count.
For the method of average processing, refer to "Average Mode" in the Config → Parameter Setup.

Config***Parameter Setup***

Sets measurement conditions and so on.

3.3 Functional Description

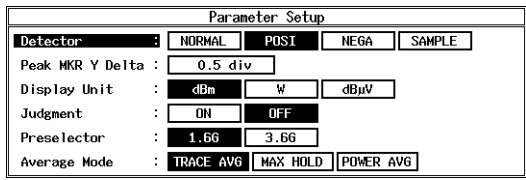

Figure 3-18 Parameter Setup Dialog Box

- Detector** NORMAL/POSI/NEGA/SAMPLE
Sets the detector.

- Peak MKR Y Delta**
Sets the Y delta of a peak marker.

- Display Unit** dBm/W/dBμV
Sets the display unit.

- Judgment** Makes the Pass/Fail judgment using the limit values set by Table Edit.

- Preselector** Sets the preselector.

NOTE: This menu is displayed on R3267 only.

- 1.6G: Used to measure harmonics of more than 1.6 GHz or spurious signals when the carrier frequency is lower than 1.6 GHz.
- 3.6G: Used to set this parameter for cases other than that above.

- Average Mode** Selects the processing method when Average Times is set to ON.
 - TRACE AVG:
Calculates arithmetic average of the measured data (Log data) in the mode LOG.
 - MAX HOLD:
Displays the maximum value within the average counts of the swept waveforms.
 - POWER AVG:
Converts the measured data (Log data) to the linear data to take the root mean square value.

Set to Default Returns the set value to the default.

3.3.4 Modulation

Performs the modulation analysis using a DSP.

3.3.4.1 3GPP

Perform measurements by inversely spreading the measurement signal as a 3GPP signal.
Can measure the code domain power coefficient.

Auto Level Set Sets an internal reference level (REF LEVEL) to the optimum value in agreement with the measurement signal.

NOTE: *The level of an input signal must be constant during the execution of Auto Level Set.*

Display Type Switches the result display.

Format

Format dialog box is displayed.

NUMERIC: Displays the measurement result.

GRAPH: Displays a graph for the code domain power coefficient and the power.

TABLE: Displays the code domain power coefficient, power (relative and absolute values) and EVM.

Display

Toggles the display mode between Single and Dual.

SINGLE: Displays data on a one-screen.

DUAL: Displays data on a dual-screen; displays the graph on the upper screen and the measurement result on the lower screen. (Only for DOWNLINK)

Y Scale

Sets the Y scale unit.

ρ : Displays the vertical axis of the graph in the code domain power coefficients.
When selecting any items other than ACTIVE, the sum total of the code domain power coefficients for each channel is 1.

POWER [dB]:

Displays the power (relative value) along the Y axis.
The power of the signal to be measured per slot is 0 dB.

POWER [dBm]:

Displays the power (absolute value) as a list.
Can be selected when Format is set to TABLE.

E.V.M.:

Displays Error Vector Magnitude as a list.
Can be selected when Format is set to TABLE.

3.3 Functional Description

X Scale

Sets the X scale unit.

CODE: Displays the horizontal axis of the graph in channel numbers (codes).
 A ρ for each channel with an arbitrary time or a graph for the power is displayed. Set the time to be displayed using View Point.

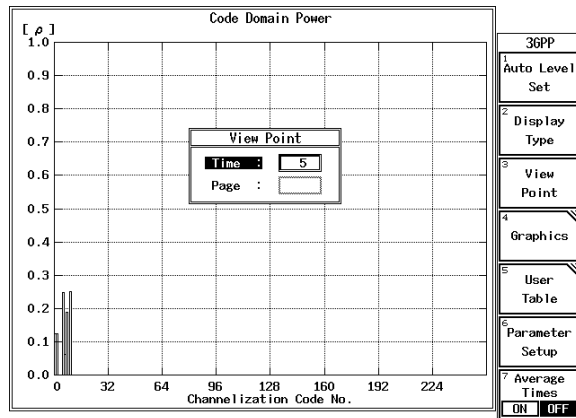

Figure 3-19 Selecting the Unit of the Graph Horizontal Axis (for Channel Number)

TIME: Displays the horizontal axis of the graph in units of time. Displays a ρ in a specific Code or a graph for a variation over time of the power. Set the Code to be displayed using View Point. One division of time is the number of symbols specified by Meas Unit of Parameter Setup and the maximum measurement length is 2560 chips.

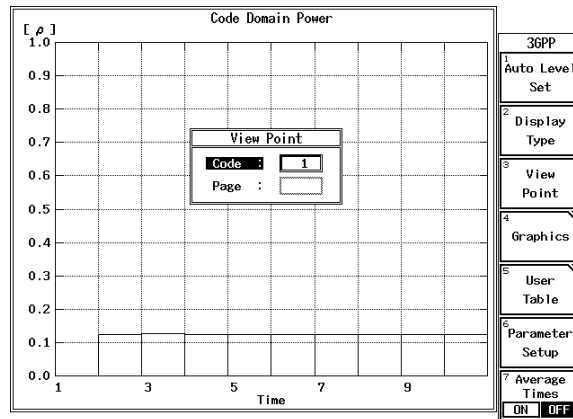

Figure 3-20 Selecting the Unit of the Graph Horizontal Axis (for Time)

View Point**Time (Code)**

Selects the X scale for a graphical display.

TIME: Sets the X scale to time.

CODE: Sets the X scale to codes.

Page

Switches the screen if the data cannot be displayed on a one-screen when TABLE is selected in Display Type.

Graphics

Displays a constellation or an eye diagram.

Display Start

Sets the display starting position. Setting values, 0 through 2432 chips, are available.

Select Type

Sets the 3 GPP display format.

The 3GPP display format differs according to whether Meas Mode is SLOT or FRAME.

When Meas Mode is set to FRAME and LINK is set to UPLINK, refer to (a) for more information.

When Meas Mode is set to SLOT and LINK is set to DOWNLINK or UPLINK, refer to (b) for more information.

When Meas mode is set to FRAME and LINK is set to DOWNLINK, refer to (c) for more information.

- (a) When Meas Mode is set to FRAME and LINK is set to UPLINK

I EYE Diagram:

Displays the eye pattern of the I channel. (When Meas Branch is I.)

Q EYE Diagram:

Displays the eye pattern of the Q channel. (When Meas Branch is Q.)

E.V.M. vs Symbol:

Displays EVM for 1 symbol.

- (b) When Meas Mode is set to SLOT and LINK is set to DOWNLINK or UPLINK

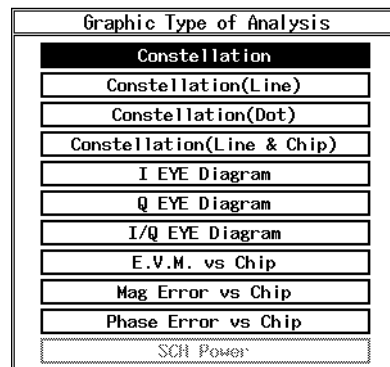

Figure 3-21 Graph Type of Analysis Dialog Box

3.3 Functional Description

- Constellation:
Displays a constellation graph.
- Constellation(Line):
Displays the transition between chips with connected lines.
- Constellation(Dot):
Display the transition between chips with dots.
- Constellation(Line & Chip):
Displays the transition between chips with connected lines and dots.
- I EYE Diagram:
Displays the eye pattern of the I channel.
- Q EYE Diagram:
Displays the eye pattern of the Q channel.
- I/Q EYE Diagram:
Displays the I channel eye pattern in the upper part of the screen and the Q channel eye pattern in the lower part of the screen.
- E.V.M. vs Chip:
Displays EVM for 1 chip.
- Mag Error vs Chip:
Displays the magnitude error for 1 chip.
- Phase Error vs Chip:
Displays the phase error for 1 chip.

(c) When Meas Mode is set to FRAME and LINK is set to DOWNLINK

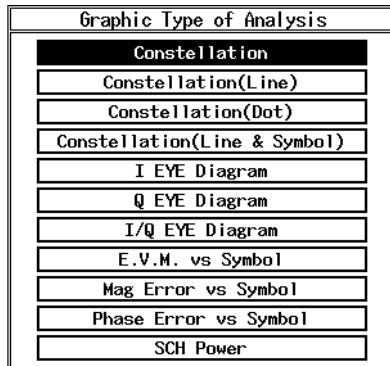

Figure 3-22 Graph Type of Analysis Dialog Box

- Constellation:
Displays a graph for a constellation.

	<p>Constellation(Line): Displays the transition between symbol points connected with lines.</p> <p>Constellation(Dot): Displays the transition between symbol points with dots.</p> <p>Constellation(Line & Symbol): Displays the transition between symbol points connected with lines and with dots.</p> <p>I EYE Diagram: Displays the eye pattern for I channel.</p> <p>Q EYE Diagram: Displays the eye pattern for Q channel.</p> <p>I/Q EYE Diagram: Displays the eye patterns for I and Q simultaneously.</p> <p>E.V.M. vs Symbol: Displays EVM for each symbol.</p> <p>Mag Error vs Symbol: Displays the magnitude error for each symbol.</p> <p>Phase Error vs Symbol: Displays the phase error for each symbol.</p> <p>SCH Power: Display the SCH power for each slot.</p>
<i>45deg Turn</i>	Displays the I and Q patterns turned by 45°.
<i>Demod Data Save</i>	Saves the demodulated data to a floppy disk. (Only for FRAME)
<i>User Table</i>	Sets the spreading factor and code number for the transmission channel to be used when <i>USER TABLE</i> is selected as Active CH. Detection of DOWNLINK,.
<i>Test Model 1 DPCH 16 code</i>	The spreading factor and code number of the multiplexed channel is automatically set to Test Model1 (DPCH 16 codes) compliant with TS25.141 V3.5.0.
<i>Test Model 1 DPCH 32 code</i>	The spreading factor and code number of the multiplexed channel is automatically set to Test Model1 (DPCH 32 codes) compliant with TS25.141 V3.5.0.

3.3 Functional Description

<i>Test Model 1 DPCH 64 code</i>	The spreading factor and code number of the multiplexed channel is automatically set to Test Model1 (DPCH 64 codes) compliant with TS25.141 V3.5.0.
<i>Test Model 2</i>	The spreading factor and code number of the multiplexed channel is automatically set to Test Model2 compliant with TS25.141 V3.5.0.
<i>Test Model 3 DPCH 16 code</i>	The spreading factor and code number of the multiplexed channel is automatically set to Test Model3 (DPCH 16 codes) compliant with TS25.141 V3.5.0.
<i>Test Model 3 DPCH 32 code</i>	The spreading factor and code number of the multiplexed channel is automatically set to Test Model3 (DPCH 32 codes) compliant with TS25.141 V3.5.0.
<i>Table Edit</i>	Sets the spreading factor and code number of the transmission channels manually.
<i>Multi Channel No.</i>	Sets the number of channels multiplexed on the signal under measurement. The number of channels 1 to 32 can be set. However, the number does not include SCH.
<i>SF/Number/Rate</i>	Sets the channel numbers and spreading factors (rates) for the channels set as Multi Channel No. Primary CPICH: Sets the spreading factor (rate) and code number for Primary CPICH. Ch N: Sets the spreading factor (rate) and code number for the channel N. Where, N is 1 through (the number of channels set as Multi Channel No. - 1).

NOTE: If a code number which does not meet orthogonality between different channels is set, a measurement error occurs.

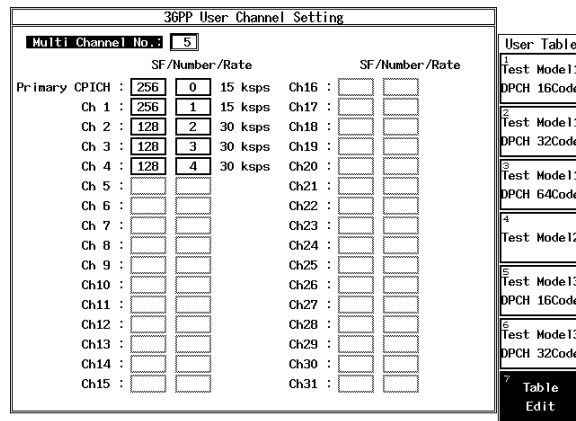

Figure 3-23 3GPP User Channel Setting Dialog Box

Parameter Setup

Sets the measurement parameter.

The measurement parameter setup screen varies whether Meas Mode is SLOT or Frame and whether LINK is DOWNLINK or UPLINK.

When Meas Mode is set to SLOT and LINK is set to DOWNLINK, refer to (a) for more information.

When Meas Mode is set to FRAME and LINK is set to DOWNLINK, refer to (b) for more information.

When Meas Mode is set to SLOT and LINK is set to UPLINK, refer to (c) for more information.

When Meas Mode is set to FRAME and LINK is set to UPLINK, refer to (d) for more information.

- (a) When Meas Mode is set to SLOT and LINK is set to DOWNLINK

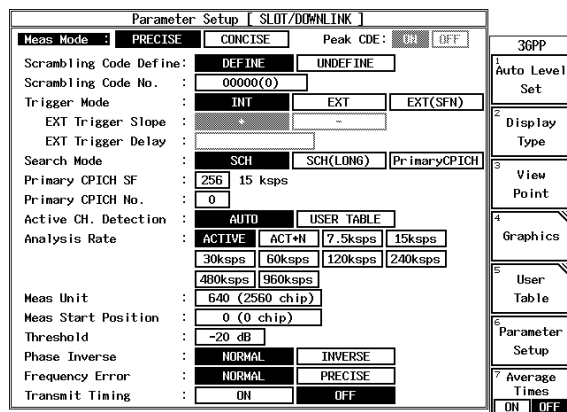

Figure 3-24 Parameter Setup [SLOT/DOWNLINK] Dialog Box

3.3 Functional Description

<i>Meas Mode</i>	<p>Selects whether all items or some of the items are measured.</p> <p>PRECISE: Measures all items.</p> <p>CONCISE: Measures only the ρ, carrier frequency error, Error Vector Magnitude and Peak Code Domain Error.</p> <hr/> <p><i>NOTE: Graphic display is not available for CONCISE.</i></p> <hr/>
<i>Peak CDE</i>	<p>Selects whether Peak Code Domain Error is measured when Meas Mode is set to CONCISE.</p> <p>ON: Measures Peak Code Domain Error.</p> <p>OFF: Does not measure Peak Code Domain Error.</p>
<i>Scrambling Code Define</i>	<p>Selects whether to use the scrambling code set to perform the measurement or to search S-SCH for the scrambling code number to perform the measurement.</p> <p>DEFINE: Uses the scrambling code set to perform the measurement.</p> <p>UNDEFINE: Searches for a Scrambling code number from the S-SCH to perform measurements. This function is used when the Scrambling code number cannot be determined.</p>
<i>Scrambling Code No.</i>	<p>Sets Scrambling codes used when measuring to hexadecimal format. Codes can be set in the range 0 to 3FFFE by using the following keys:</p> <p>A: SHIFT, 0</p> <p>B: SHIFT, 1</p> <p>C: SHIFT, 2</p> <p>D: SHIFT, 3</p> <p>E: SHIFT, 4</p> <p>F: SHIFT, 5</p>
<i>Trigger Mode</i>	<p>Selects the timing at which data is stored.</p> <p>INT: Stores data at the timing of the internal trigger.</p> <p>EXT: Stores data at the timing of the external trigger. Time Out occurs after approximately five seconds.</p> <p>EXT (SFN): Stores data at the timing of the external trigger. Time Out occurs after approximately two minutes.</p>

<i>EXT Trigger Slope</i>	Selects the slope of timing at which data is stored. +: Stores data at the leading edge. -: Stores data at the trailing edge.
<i>EXT Trigger Delay</i>	Sets a delay to the timing of the external trigger. Delay times -5120.0 through 38400.0 (chips) can be set.
<i>Search Mode</i>	Selects the mode of acquiring synchronization. SCH: Searches for a SCH to acquire synchronization. SCH (LONG): Searches SCH to acquire synchronization. While it has greater efficiency of synchronization compared to Search Mode SCH, it requires a longer measurement time. Primary CPICH: Searches Primary CPICH to acquire synchronization. When Trigger Mode is INT, searches one period of Primary CPICH. When Trigger Mode is EXT, searches the first frame of Primary CPICH within the range of 100 chips both prior to and subsequent to the trigger.
<i>Primary CPICH SF</i>	Sets the spreading factor (rate) of Primary CPICH. The factors 4 through 512 can be set.
<i>Primary CPICH No.</i>	Sets the code number of Primary CPICH.
<i>Active CH. Detection</i>	Selects the mode in which the channels currently transmitting data are detected. AUTO: Automatically detects the rates and code numbers of the channels currently transmitting data. USER TABLE: Sets the data rate and code number of the transmission channel according to the user table.
<i>Analysis Rate</i>	Selects the rates used for the code domain analysis. ACTIVE: Uses the rates of the channels currently transmitting data for measurement. ACT+N: Uses the rates of the channels currently transmitting data for measurement. Uses 7.5 ksps as the rate for noise measurement. 7.5 ksps: Uses 7.5 ksps as the rate for measurement. 15 ksps: Uses 15 ksps as the rate for measurement. 30 ksps: Uses 30 ksps as the rate for measurement.

3.3 Functional Description

60 kbps:	Uses 60 kbps as the rate for measurement.
120 kbps:	Uses 120 kbps as the rate for measurement.
240 kbps:	Uses 240 kbps as the rate for measurement.
480 kbps:	Uses 480 kbps as the rate for measurement.
960 kbps:	Uses 960 kbps as the rate for measurement.

Meas Unit

The measurement unit used to measure a code domain power coefficient and code domain power is set. Then the code domain power coefficient and code domain power are measured for each measurement unit. The range for the measurement unit is within the range of 1 to 640 (4 chips and 2560 chips) when Analysis Rate is set to ACTIVE, or within the range of 1 symbol to (2560/S) symbols when Analysis Rate is set to any positions other than ACTIVE. "S" means the code length (in chips) of the rate selected in Analysis Rate.

Channel Power

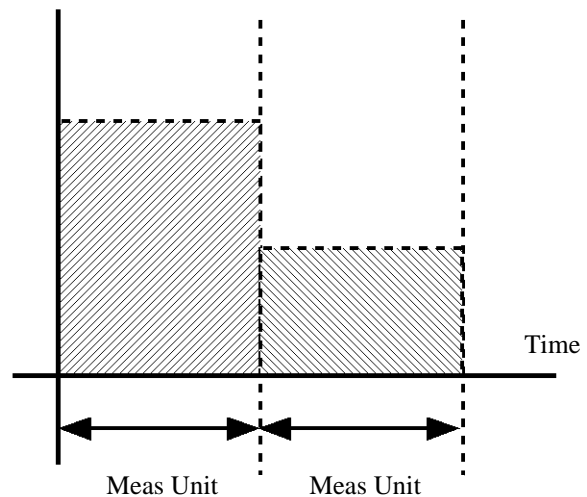

Figure 3-25 Explanation Diagram of MEAS Unit

Meas Start Position

Sets the position to start the measurement. The set range is 0 through 140 (0 chip through 35840 chips).

Threshold

Sets a threshold value to judge whether or not the channel is active. A reference value is the mean power of the Primary CPICH. The judgement of the active channel is made for each symbol. As a result, the symbol having the mean power equal to or greater than (the mean power of the Primary CPICH) + (CDP threshold) is judged as active.

The setting range of a threshold value is between -5 dB and -40 dB.

NOTE: When a large threshold value is set, an active channel is judged as passive. As a result, ρ and modulation accuracy become worse than actual values, causing incorrect measurements. On the other hand when a small threshold value is set, a passive channel is judged as active. As a result, ρ and modulation accuracy become better than actual values, causing incorrect measurements.

Phase Inverse

Selects whether or not to invert the phase of IQ signals.

NORMAL: Does not invert the sign of IQ signals.

INVERSE: Inverts the sign of IQ signals.

Frequency Error

Switches the estimated accuracy for the carrier frequency error.

NORMAL: Estimates the error with normal accuracy.

PRECISE: Estimates the error with high accuracy.

Transmit Timing

Switches between on and off of the transmission timing measurement between channels.

ON: Measures the transmission timing of each channel for Primary CPICH.

OFF: Does not measure the above transmission timing of each channel for Primary CPICH.

- (b) When Meas Mode is set to FRAME and LINK is set to DOWNLINK

Parameter Setup [FRAME/DOWNLINK]	
Scrambling Code Define:	DEFINE UNDEFINE
Scrambling Code No. :	00000(0)
Trigger Mode :	INT EXT EXT(SFN)
EXT Trigger Slope :	+
EXT Trigger Delay :	
Search Mode :	SCH SCH(LONG) PrimaryCPICH
Primary CPICH SF :	256 15 kspcs
Primary CPICH No. :	0
Active CH. Detection :	AUTO USER TABLE
Meas Channel SF :	256 15 kspcs
Meas Channel No. :	0
Meas Slots :	15
Meas Start Position :	0 (0 chip)
Threshold :	-20 dB
Phase Inverse :	NORMAL INVERSE

Figure 3-26 Parameter Setup [FRAME/DOWNLINK] Dialog Box

Scrambling Code Define

Selects whether to use the scrambling code set to perform the measurement or to search S-SCH for the scrambling code number to perform the measurement.

DEFINE: Uses the scrambling code set to perform the measurement.

3.3 Functional Description

UNDEFINE: Searches for a scrambling code number from the S-SCH to perform measurements. This function is used when the scrambling code number cannot be determined.

Scrambling Code No.

Sets Scrambling codes used when measuring to hexadecimal format. Codes can be set in the range 0 to 3FFFE by using the following keys:

- A: **SHIFT, 0**
- B: **SHIFT, 1**
- C: **SHIFT, 2**
- D: **SHIFT, 3**
- E: **SHIFT, 4**
- F: **SHIFT, 5**

Trigger Mode

Selects the timing at which data is stored.

INT: Stores data at the timing of the internal trigger.

EXT: Stores data at the timing of the external trigger. Time Out occurs after approximately five seconds.

EXT (SFN): Stores data at the timing of the external trigger. Time Out occurs after approximately two minutes.

EXT Trigger Slope

Selects the slope of timing at which data is stored.

+: Stores data at the leading edge.

-: Stores data at the trailing edge.

EXT Trigger Delay

Sets a delay to the timing of the external trigger. Delay times -5120.0 through 38400.0 (chips) can be set.

Search Mode

Selects the mode of acquiring synchronization.

SCH: Searches for a SCH to acquire synchronization.

SCH (LONG):

Searches SCH to acquire synchronization.

While it has greater efficiency of synchronization compared to Search Mode SCH, it requires a longer measurement time.

Primary CPICH:

Searches Primary CPICH to acquire synchronization. When Trigger Mode is INT, searches the one period of Primary CPICH.

When Trigger Mode is EXT, searches the first frame of Primary CPICH within the range of 100 chips both prior to and subsequent to the trigger.

<i>Primary CPICH SF</i>	Sets the spreading factor (rate) of Primary CPICH. The factors 4 through 512 can be set.
<i>Primary CPICH No.</i>	Sets the code number of Primary CPICH.
<i>Active CH. Detection</i>	<p>Selects the mode of detecting the transmission channel.</p> <p>AUTO: Automatically detects the data rate and code number of the transmission channel.</p> <p>USER TABLE: Sets the data rate and code number of the transmission channel according to the user table.</p>
<i>Meas Channel SF</i>	Sets the spreading factor of the channel under measurement.
<i>Meas Channel No.</i>	Sets the code number of the channel under measurement.
<i>Meas Slots</i>	<p>Sets the code domain power coefficient and the range (number of slots) for power measurement.</p> <p>Separates the signal under measurement into each one slot and measures the code domain power coefficient and power for each slot.</p> <p>The set range of slots is 1 through 30.</p>

Channel Power

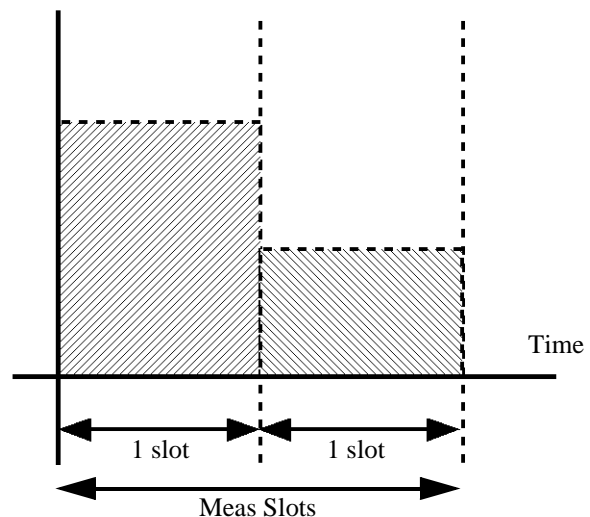
**Figure 3-27 Explanation Diagram of MEAS Slots**

<i>Meas Start Position</i>	<p>Sets the measurement start position (the number of symbols from the head of a slot).</p> <p>The setting range is 0 through $(2560/S-1)$ symbols. Where, S is Meas Channel SF.</p>
----------------------------	---

3.3 Functional Description

Threshold

Sets a threshold value to judge whether or not the channel is active. A reference value is the mean power of the Primary CPICH. The judgement of the active channel is made for each symbol. As a result, the symbol having the mean power equal to or greater than (the mean power of the Primary CPICH) + (CDP threshold) is judged as active.

The setting range of a threshold value is between -5 dB and -40 dB.

NOTE: When a large threshold value is set, an active channel is judged as passive. As a result, ρ and modulation accuracy become worse than actual values, causing incorrect measurements. On the other hand when a small threshold value is set, a passive channel is judged as active. As a result, ρ and modulation accuracy become better than actual values, causing incorrect measurements.

Phase Inverse

Selects whether or not to invert the phase of IQ signals.

NORMAL: Does not invert the sign of IQ signals.

INVERSE: Inverts the sign of IQ signals.

- (c) When Meas Mode is set to SLOT and LINK is set to UPLINK

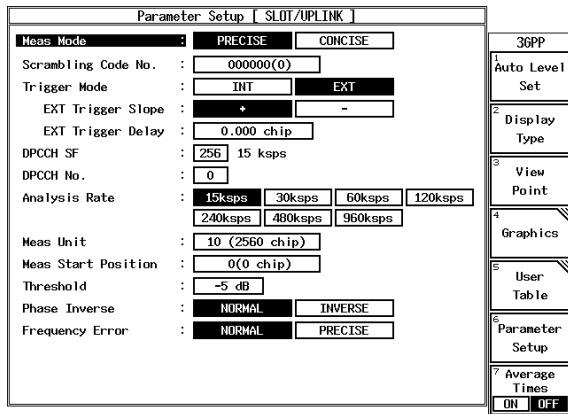

Figure 3-28 Parameter Setup [SLOT/UPLINK] Dialog Box

Meas Mode:

Selects whether all items or some of the items are measured.

PRECISE: Measures all items.

CONCISE: Measures only the ρ , carrier frequency error, Error Vector Magnitude and Peak Code Domain Error.

NOTE: Graphic display is not available for CONCISE.

<i>Scrambling Code No.</i>	Sets Scrambling codes to hexadecimal format. Codes can be set in the range 0 to FFFFFFFF by using the following keys: A: SHIFT, 0 B: SHIFT, 1 C: SHIFT, 2 D: SHIFT, 3 E: SHIFT, 4 F: SHIFT, 5
<i>Trigger Mode</i>	Selects the timing at which data is stored. INT: Stores data at the timing of the internal trigger. EXT: Stores data at the timing of the external trigger.
<i>EXT Trigger Slope</i>	Selects the slope of timing at which data is stored. +: Stores data at the leading edge. -: Stores data at the trailing edge.
<i>EXT Trigger Delay</i>	Sets a delay to the timing of the external trigger. Delay times -5120.0 through 38400.0 (chips) can be set.
<i>DPCCH SF</i>	Sets the spreading factor (rate) of the DPCCH. The factors 4 through 256 can be set.
<i>DPCCH No.</i>	Sets the DPCCH code number.
<i>Analysis Rate</i>	Selects the rates used for the code domain analysis. 15 kbps: Uses the rate as 15 kbps for measurement. 30 kbps: Uses the rate as 30 kbps for measurement. 60 kbps: Uses the rate as 60 kbps for measurement. 120 kbps: Uses the rate as 120 kbps for measurement. 240 kbps: Uses the rate as 240 kbps for measurement. 480 kbps: Uses the rate as 480 kbps for measurement. 960 kbps: Uses the rate as 960 kbps for measurement.
<i>Meas Unit</i>	Sets the range (number of symbols) in which the code domain power coefficient and the power will be measured. The signal to be measured is divided into lengths of the set number of symbols. The code domain power coefficient and the power are measured for each time range. A value of between 1 and (2560/S) can be set. However, S is a short record length (number of chips) selected as Analysis Rate.

3.3 Functional Description

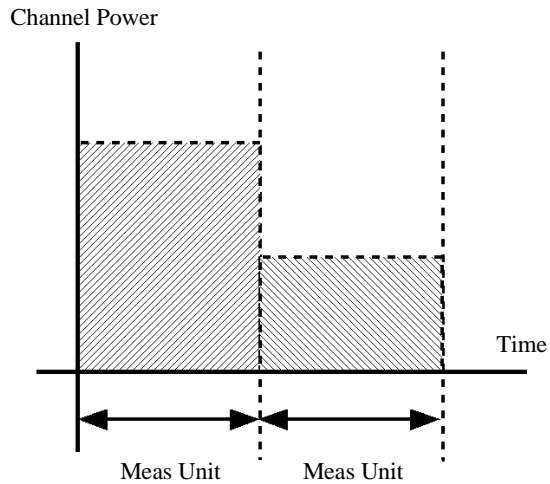

Figure 3-29 Explanation Diagram of MEAS Unit

Meas Start Position

Set the position where the measurement has started. The set range is from 0 to 140 (0 to 35840 chips).

Threshold

Sets a threshold value to judge whether or not the channel is active. A reference value is the mean power of the DPCCH. The judgement of the active channel is made for each symbol. As a result, the symbol having the mean power equal to or greater than (the mean power of the DPCCH) + (CDP threshold) is judged as active.

The setting range of a threshold value is between -5 dB and -40 dB.

NOTE: *When a large threshold value is set, an active channel is judged as passive. As a result, ρ and modulation accuracy become worse than actual values, causing incorrect measurements. On the other hand when a small threshold value is set, a passive channel is judged as active. As a result, ρ and modulation accuracy become better than actual values, causing incorrect measurements.*

Phase Inverse

Selects whether or not to invert the phase of IQ signals.

NORMAL: Does not invert the phase of Q signals.

INVERSE: Inverts the phase of Q signals.

Frequency Error

Switches the estimated accuracy for the carrier frequency error.

NORMAL: Estimates the error with normal accuracy.

PRECISE: Estimates the error with high accuracy.

- (d) When Meas Mode is set to FRAME and LINK is set to UPLINK

Parameter Setup [FRAME/UPLINK]	
Scrambling Code No.	000000(0)
Trigger Mode	INT EXT
EXT Trigger Slope	+ -
EXT Trigger Delay	0.000 chip
DPCCH SF	256 15 kbps
DPCCH No.	0
Meas Channel SF	256 15 kbps
Meas Channel No.	0
Meas Branch	I Q
Meas Slots	15
Meas Start Position	0 (0 chip)
Threshold	-5 dB
Phase Inverse	NORMAL INVERSE

Figure 3-30 Parameter Setup [FRAME/UPLINK] Dialog Box

Scrambling Code No.

Sets Scrambling codes to hexadecimal format. Codes can be set in the range 0 to FFFFFFFF by using the following keys:

- A: SHIFT, 0
- B: SHIFT, 1
- C: SHIFT, 2
- D: SHIFT, 3
- E: SHIFT, 4
- F: SHIFT, 5

Trigger Mode

Switches the trigger mode between the internal and external trigger.

- INT: Captures data using the internal trigger.
- EXT: Captures data using the external trigger.

EXT Trigger Slope

Switches the polarity of the external trigger slope.

- +: Captures data at the leading edge.
- : Captures data at the trailing edge.

EXT Trigger Delay

Sets a delay to the external trigger timing. The delay times -5120.0 through 38400.0 (chips) can be set.

DPCCH SF

Sets the spreading factor (rate) of the DPCCH. The factors 4 through 256 can be set.

DPCCH No.

Sets the DPCCH code number.

Meas Channel SF

Sets the spreading factor of the channel to be measured.

Meas Channel No.

Sets the code number for the channel under measurement.

3.3 Functional Description

Meas Branch Selects the measurement branch of the channel to be measured from I or Q.
 I: Measures the I side.
 Q: Measures the Q side.

Meas Slots Sets the code domain power coefficient and the range (the number of slots) for power measurement. Separates the signal under measurement into each one slot and measures the code domain power coefficient and power for each slot. The set range of slots is 1 through 30.

Channel Power

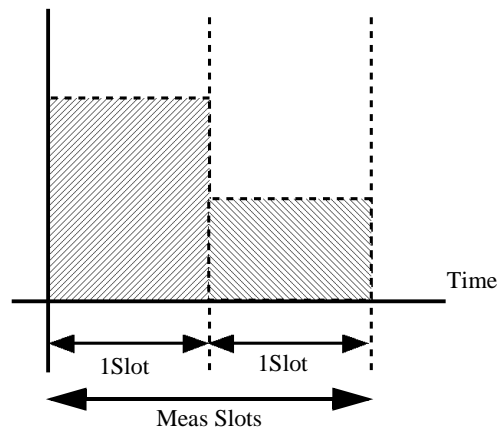

Figure 3-31 Examination Diagram of Meas Slots

Meas Start Position Sets the measurement start position (the number of symbols from the head of a slot). The measurement range is 0 through $(2560/S-1)$ symbols. Where, S is Meas Channel SF.

Threshold Sets a threshold value to judge whether or not the channel is active. A reference level is the mean power of DPCCH. In addition, the judgment of the active channel is made for each symbol. As a result, the symbol having the mean power equal to or greater than $(\text{the mean power of DPCCH}) + (\text{CDP threshold})$ is judged as active. The set range for a threshold value is -5 dB through -40 dB.

NOTE: When a large threshold level is set, an active channel is judged as inactive. As a result, ρ and modulation accuracy become worse than actual values, causing incorrect measurements. On the other hand, when a small threshold level is set, an inactive channel is judged as active. As a result, ρ and modulation accuracy become better than actual values, causing incorrect measurements.

Phase Inverse

Selects whether or not to invert the IQ signal phases.

NORMAL: Does not invert the sign of the Q signal.

INVERSE: Inverts the sign of the Q signal.

Average Times ON/OFF

Selects an averaging process.

ON: Activates the number of times of averaging and performs averaging the specified number of times.

OFF: Does not perform an averaging process.

NOTE: Although the averaging of the power is performed, the average is not shown on the Code Domain Power Graph display.

3.3 Functional Description

3.3.4.2 QPSK

Assumes the measurement signal as a QPSK signal to perform measurement.

NOTE: *The instrument supports the chip rate of 3.84 Mcps.*

Auto Level Set

Sets an internal reference level (REF LEVEL) to the optimum value in agreement with the measurement signal.

NOTE: *The level of an input signal must be constant during the execution of Auto Level Set.*

Graphics

Displays a constellation or an eye diagram.

Display Start

Sets the display starting position.

Select Type

Graphic Type of Analysis dialog box is displayed.

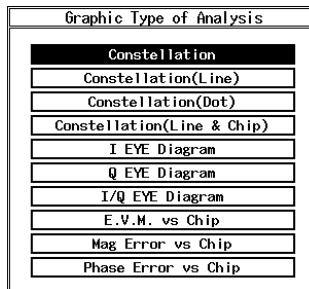

Figure 3-32 Graphic Type of Analysis Dialog Box

Constellation:

Displays a graph for a constellation.

Constellation(Line):

Displays the transition between symbol points connected with lines.

Constellation(Dot):

Displays the transition between symbol points with dots.

Constellation(Line & Chip):

Displays the transition between symbol points connected with lines and with dots.

I EYE Diagram:

Displays the eye pattern for I channel.

Q EYE Diagram:

Displays the eye pattern for Q channel.

I/Q EYE Diagram:

Displays the eye patterns for I and Q simultaneously.

E.V.M. vs Chip:

Displays a graph of the magnitude of error vectors for each symbol.

Mag Error vs Chip:

Displays a graph of magnitude errors for each symbol.

Phase Error vs Chip:

Displays a graph of phase errors for each symbol.

Parameter Setup

Sets the measurement parameter.

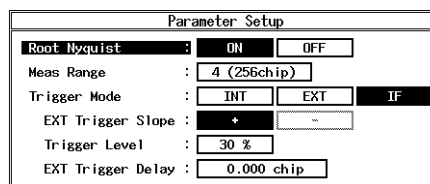

Figure 3-33 QPSK Measurement parameter set Dialog Box

Root Nyquist

Switches the Root Nyquist filter between ON and OFF.

ON: Enables the Root Nyquist filter.

OFF: Does not use the Root Nyquist filter.

Meas Range

Sets the measurement length for modulation accuracy and so on. The range is 4 through 20. One measurement length is 64 chips.

Trigger Mode

Selects the timing at which the data is stored.

INT: Stores data at the timing of the internal trigger.

EXT: Stores data at the leading edge of the external trigger. At this moment, a trigger delay can be set.

IF: Stores data at the signal level.

EXT Trigger Slope

Selects the slope of timing at which data is stored.

+: Stores data at the leading edge.

-: Stores data at the trailing edge.

Trigger Level

Sets the trigger level (which is relative to the reference level and is used as the initial level when retrieving data in the IF trigger mode).

Can be set between 0% and 100% in steps of 1%.

3.3 Functional Description

EXT Trigger Delay

Sets a delay time from the trigger point in units of chip.

NOTE: *When a negative value is set, a signal before the trigger can be observed.*

Average Times ON/OFF

Selects an averaging process.

ON: Activates the number of times of averaging and performs averaging the specified number of times.

OFF: Does not perform an averaging process.

Limit Setup

Sets the limit values.

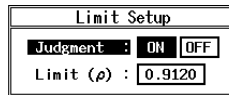

Figure 3-34 Limit Setup Dialog Box

Judgment

Toggles the judgment ON and OFF.

ON: Makes judgment.

OFF: Does not make judgment.

Limit (ρ)

Enter a numeric value used for judgement.

3.3.4.3 Power

3.3.4.3.1 Tx Power

Measures the power of a modulation signal.

Auto Level Set

Sets an internal reference level (REF LEVEL) to the optimum value in agreement with the measurement signal.

NOTE: *The level of an input signal must be constant during the execution of Auto Level Set.*

Parameter Setup

Sets measurement conditions and so on.

Parameter Setup	
Root Nyquist	: <input type="button" value="ON"/> <input type="button" value="OFF"/>
Trigger Mode	: <input type="button" value="INT"/> <input type="button" value="EXT"/>
EXT Trigger Slope	: <input type="button" value="+"/> <input type="button" value="-"/>
EXT Trigger Delay	: <input type="text" value="0.000 chip"/>

Figure 3-35 Parameter Setup Dialog Box

Root Nyquist

Toggles a Root Nyquist filter between on and off.

ON: Enables the Root Nyquist filter.

OFF: Disables the Root Nyquist filter.

Trigger Mode

Selects a trigger signal.

INT: Sweeps in synchronization with an internal trigger signal.

EXT: Sweeps in synchronization with an external trigger signal, which is input from the Ext Trigger connector on the rear panel.

EXT Trigger Slope

Changes the polarity of the trigger slope.

+: Starts sweeping at the leading edge of the trigger.

-: Starts sweeping at the trailing edge of the trigger.

EXT Trigger Delay

Sets a delay time from the trigger point in units of chip.

NOTE: *Although the averaging of the power is performed, the average is not shown on the trace display.*

3.3 Functional Description

Average Times ON/OFF

Selects an averaging process.

ON: Activates the number of times of averaging and performs averaging the specified number of times.

OFF: Does not perform an averaging process.

NOTE: The peak factor is expressed as the peak power divided by the average power.

3.3.4.3.2 Power vs Time

Waveforms of measured powers can be displayed as well as average power and peak factor for each slot (666.66 μ s).

Auto Level Set

Automatically adjusts the reference level.

Scale Setup

Switches between measurement results.

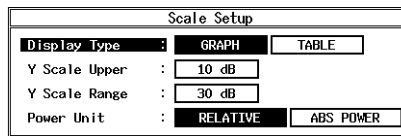

Figure 3-36 Scale Setup Dialog Box

Display Type

Selects the display type of the measurement values. It is used only when CONCISE from the Meas mode is selected.

GRAPH: Displays the measurement value graphically.

TABLE: Displays the measurement value in table.

Y Scale Upper

Sets the maximum value along the vertical axis between -20 dB(m) and 70 dB(m) in steps of 10 dB.

Y Scale Range

Sets the display range along the vertical axis between 10 dB(m) and 50 dB(m) in steps of 10 dB.

Power Unit

Sets the unit that is displayed.

RELATIVE:

Displays the power relative to the average power of the slot head.

ABS POWER:

Displays the power in absolute value.

Parameter Setup

Sets the parameters used for measurements.

Parameter Setup		
Meas Mode	:	<input checked="" type="radio"/> PRECISE <input type="radio"/> CONCISE
Root Nyquist	:	<input checked="" type="radio"/> ON <input type="radio"/> OFF
Trigger Mode	:	<input type="radio"/> INT <input type="radio"/> IF
		<input checked="" type="radio"/> EXT
Trigger Slope	:	<input checked="" type="radio"/> + <input type="radio"/> -
Trigger Level	:	<input type="text"/>
Trigger Delay	:	<input type="text" value="0.00"/> μ s
Meas Length	:	<input type="text" value="2"/> slot
Graph Plot Type	:	<input checked="" type="radio"/> AVERAGE <input type="radio"/> PEAK-PEAK
Unit Transient Section for AVG Power	:	<input type="radio"/> ON <input checked="" type="radio"/> OFF

Figure 3-37 Parameter Setup Dialog Box

Meas Mode

Selects the measurement mode.

PRECISE:

Calculates the electric power by sample to display them. This is used when checking the detailed peak factor.

CONCISE:

Calculates the electrical power by slot. It is used when reducing the measurement time.

Root Nyquist

Sets whether or not the Root Nyquist filter (with a chip rate of 3.84 Mcps and a rolloff of 0.22) is used.

ON: The Root Nyquist filter is used for the measurement.

OFF: The Root Nyquist filter is not used for the measurement.

Trigger Mode

Selects the timing for retrieving data.

INT: Captures data using the internal trigger.

IF: Captures data using the signal level.

EXT: Captures data using the external trigger.

Trigger Slope

Toggles the external trigger slope between + and -.

+: Captures data at the rising edge.

-: Captures data at the falling edge.

Trigger Level

Sets the trigger level (which is relative to the reference level and is used as the initial level when retrieving data in the IF trigger mode).

Can be set between 0% and 100% in steps of 1%.

3.3 Functional Description

Trigger Delay Delays the IF or external triggers.
 For the IF trigger:
 Can be set between -40 ms and 666.66 μ s in steps of 0.01 μ s.
 For the external trigger:
 Can be set between -40 ms and 666.66 μ s in steps of 0.01 μ s.

Meas Length Sets the slot length of the power measurement.
 Can be set between Slot 2 and Slot 62.

Graph Plot Type Selects the graph display format.
 AVERAGE:
 Displays the graph with the average value.
 PEAK-PEAK:
 Displays the graph with the maximum and minimum values.

Omit Transient Section for AVG Power
 Sets whether or not the transient period (slot boundary $\pm 25 \mu$ s) is included when measuring the average power.
 ON: Excludes the transient period.
 OFF: Includes the transient period.

Marker Setup Two slot numbers which are used to display the power are set. Any slot numbers between 1 and the one specified by Meas Length can be set.

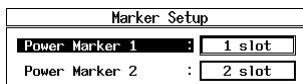

Figure 3-38 Marker Setup Dialog Box

Power Marker 1 The average power and the peak factor are displayed in the upper part.

Power Marker 2 The average power and the peak factor are displayed in the lower part.

NOTE: *The ratio is calculated from: (Average power of Power Marker 2) - (Average power of Power Marker 1).*

Template Setup Sets the boundary around which a magnified view can be displayed. Any value between 1 and the one specified by Meas Length can be set.

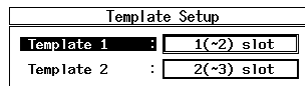

Figure 3-39 Template Setup Dialog Box

Template 1

Displayed in the lower left side of the screen.

Template 2

Displayed in the lower right side of the screen.

NOTE: *The slot numbers used for Power Marker 1 and Template Marker 1 must be less than the numbers used for Power Marker 2 and Template Marker 2, respectively.*

3.3.4.3.3 CCDF

The CCDF (Complementary Cumulative Distribution Function), average power and peak factor of the signal under measurement can be measured.

Auto Level Set

Automatically adjusts the reference level.

Scale Setup

Switches between measurement results.

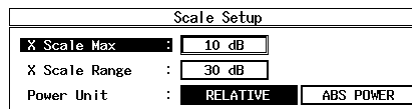

Figure 3-40 Scale Setup Dialog Box

X Scale Max

Sets the maximum value along the horizontal axis between -20 dB(m) and 70 dB(m) in steps of 10 dB.

X Scale Range

Sets the display range along the horizontal axis between 10 dB and 50 dB in steps of 10 dB.

Power Unit

Sets the unit to be displayed.

RELATIVE:

Displays the power relative to the average power.

ABS POWER:

Displays the power in absolute value.

NOTE: *If the signal power is 70 dBm or more, the power cannot be displayed in an absolute value.*

Parameter Setup

Sets the parameters used for measurements.

3.3 Functional Description

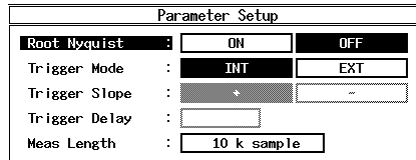

Figure 3-41 Parameter Setup Dialog Box

Root Nyquist

Sets whether or not the Root Nyquist filter (with a chip rate of 3.84 Mcps and a rolloff of 0.22) is used.

- ON: The Root Nyquist filter is used for the measurement.
- OFF: The Root Nyquist filter is not used for the measurement.

Trigger Mode

Selects the timing for retrieving data.

- INT: Captures data using the internal trigger.
- EXT: Captures data using the external trigger.

Trigger Slope

Toggles the external trigger slope between + and -.

- +: Captures data at the rising edge.
- : Captures data at the falling edge.

Trigger Delay

Delays the external trigger timing.
Can be set between -250 μ s and 250 μ s in steps of 1 μ s.

Meas Length

The number of measurement samples is set.
Can be set between 10k sample and 100M sample in steps of 10k sample.

Trace Write ON/OFF

Sets whether or not the waveform is held.

- ON: Holds the waveform.
- OFF: Does not hold the waveform.

3.3.4.3.4 P-CPICH Power

Measures the P-CPICH power and frequency error using composite signals.
This is suitable for monitoring the P-CPICH power for Base Transmitter Stations in service.
This function is available only when DOWNLINK is selected for LINK in the STD Setup.

Auto Level Set

Automatically adjusts the reference level.

NOTE: *The input signal level must be constant during the execution of Auto Level Set.*

Parameter Setup

Sets the measurement parameter.

Parameter Setup	
Scrambling Code No. :	0000(0)
Search Mode :	SCH(LONG) Primary CPICH
Meas Frame :	1

Figure 3-42 Parameter Setup Dialog Box

Scrambling Code No.

Sets Scrambling codes to hexadecimal format. Codes can be set in the range 0 to 3FFFE by using the following keys:

- A: **SHIFT, 0**
- B: **SHIFT, 1**
- C: **SHIFT, 2**
- D: **SHIFT, 3**
- E: **SHIFT, 4**
- F: **SHIFT, 5**

Search Mode

Selects the mode for acquiring synchronization.

SCH(LONG):

Searches SCH to acquire synchronization.

Primary CPICH:

Searches Primary CPICH to acquire synchronization.

Meas Frame

Sets the number of frames to be measured.

Numbers 1 to 4 can be set.

Average Times ON/OFF

Sets the averaging process to on or off.

ON: Activates the averaging process and performs averaging the specified number of times.

OFF: Does not perform an averaging process.

3.3 Functional Description

3.3.4.4 Time & FFT

An IF or base-band signal waveform in time domain and FFT waveform are displayed. This function is used to verify input signals.

Auto Level Set

Sets the internal reference level to an optimum value in accordance with the measurement signal. The reference level is automatically adjusted when this key is pressed.

NOTE: *The signal level must stay constant while Auto Level Set is being carried out.*

Select Type

Selects a graph to be displayed.

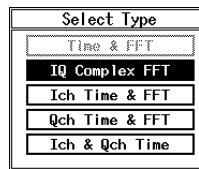

Figure 3-43 Select Type Dialog Box

Parameter Setup

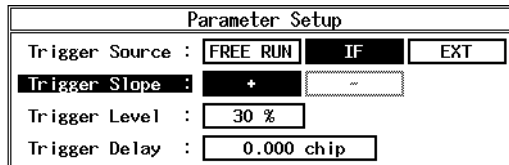

Figure 3-44 Parameter Setup Dialog Box

Trigger Source

Sets the trigger signal.

FREE RUN:

Captures data using the internal measurement timing.

IF:

Captures the signal in sync with the IF signal (the leading edge of the burst).

EXT:

Captures the signal in sync with the external trigger signal.

NOTE: *The external trigger signal is input to the EXT TRIG connector on the rear panel.*

Trigger Slope

Selects the polarity (leading or trailing edge) of a trigger signal.

Trigger Level

Sets the trigger level.

Trigger Delay

Sets a delay time from the trigger point to the moment data is captured in units of chip.

Average Times ON/OFF

Sets the averaging count.

3.3.4.5 STD

Sets parameters used for measurement and relationship between the channel number and frequency.

DC CAL

Compensates for direct current components inside the circuit.

Gain Cal

Performs a gain calibration used in the modulation analysis section.

Channel Setting

Sets the relationship between the channel number and frequency.

Copy from STD

Sets the relationship between the channel number and frequency specified by the communication standard.

UpLink: Sets the channel number of the mobile station (UE).

DownLink: Sets the channel number of the base station (BTS).

STD Setup

Sets the parameters for measurement.

STD Measurement Parameter Set	
Type :	3GPP
Meas Mode :	SLOT FRAME
Link :	UPLINK DOWNLINK
Offset Level :	0.0 dB
Frequency Input :	FREQUENCY CHANNEL
Input :	RF BASEBAND (I&Q)
Baseband Input :	#C DC
Cont Auto Level Set :	ON OFF
< for Modulation Parameter >	
Average Type :	NORMAL PEAK
EXT Trigger Source :	TTL ANALOG
EXT Trigger Level :	5.00 V

Figure 3-45 STD Measurement parameter Setup Dialog Box

Type

Selects the communication standard. Here, 3GPP is fixed.

Meas Mode

Selects the measurement modes.

SLOT: Performs the code domain analysis for the signal of one slot length.

FRAME: Performs the code domain analysis up to two frames for the specified one channel.

3.3 Functional Description

Link	Sets the direction of the signal. UPLINK: Measures the mobile unit signal. DOWNLINK: Measure the base station signal.
Offset Level	Sets reference level's offset value within a range of -100 dB to +100 dB.
Frequency Input	Sets the method of entering the center frequency to the instrument. FREQUENCY: Enters a frequency. CHANNEL: Enters a channel number.
Input	Sets an input signal route. <hr/> <i>NOTE: When entering BASEBAND and Tx Power are displayed in relative power.</i> <hr/> RF: The RF input route is set. BASEBAND (I&Q): The IQ input route is set.
Baseband Input	Selects the coupling of signals. AC: Sets an alternate current coupling. (A cutoff frequency is approx. 15 Hz) DC: Sets a direct current coupling.
Cont Auto Level Set	Sets whether to carry out the auto ranging. ON: The auto ranging is carried out on a measurement basis. OFF: The auto ranging is not carried out. <hr/> <i>NOTE: When RF is selected for Input, Cont Auto Level Set takes effect only for 3GPP, QPSK, Tx power, Power vs Time and CCDF. Use the soft key Auto Level Set when adjusting the reference level.</i> <hr/>
Average Type	Sets the average processing of both the 3GPP measurement function and the Tx Power measurement function. NORMAL: displays the arithmetic average when Average Times is set to ON.

PEAK: When Average Times is set to ON, it displays the maximum value within the Average Times counts for the Peak Magnitude Error, Peak Phase Error, Peak Error Vector Magnitude, Peak Code Domain Error of the 3GPP measurement function, and for the Peak Factor of the Tx Power measurement. For other items, arithmetic averages are displayed.

EXT Trigger Source

Selects the external trigger signal path. It is used only for the 3GPP, QPSK, Tx Power, Power vs Time, CCDF and Time & FFT measurement functions.

TTL: Selects the TTL input path.

ANALOG:

Selects the analog input path. In the analog input path, a threshold level from zero to five volts can be set.

EXT Trigger Level

When ANALOG is selected from the EXT Trigger source, a threshold level from zero to five volts can be set.

4 REMOTE CONTROL

4.1 GPIB Command Index

This GPIB command index can be used as the index for Chapter 4.

GPIB Command	Pages	GPIB Command	Pages
*CLS	4-64	3GPCH11NUM	4-47
*ESE	4-64	3GPCH11SF	4-47
*ESR	4-64	3GPCH12NUM	4-47
*IDN	4-64	3GPCH12SF	4-47
*RST	4-64	3GPCH13NUM	4-47
*SRE	4-64	3GPCH13SF	4-47
*STB	4-64	3GPCH14NUM	4-47
.	4-63	3GPCH14SF	4-47
0 to 9	4-63	3GPCH15NUM	4-47
3GPACTCH AUTO	4-42, 4-43	3GPCH15SF	4-47
3GPACTCH T1DP16	4-42, 4-43	3GPCH16NUM	4-47
3GPACTCH T1DP32	4-42, 4-43	3GPCH16SF	4-47
3GPACTCH T1DP64	4-42, 4-43	3GPCH17NUM	4-47
3GPACTCH T2	4-42, 4-43	3GPCH17SF	4-47
3GPACTCH T3DP16	4-42, 4-43	3GPCH18NUM	4-47
3GPACTCH T3DP32	4-42, 4-43	3GPCH18SF	4-47
3GPACTCH USER	4-42, 4-43	3GPCH19NUM	4-48
3GPAVG	4-48	3GPCH19SF	4-48
3GPAVGCHPWR	4-50, 4-52	3GPCH1NUM	4-46
3GPCCDF	4-61	3GPCH1SF	4-46
3GPCCDFMK	4-62	3GPCH20NUM	4-48
3GPCCDFMLN	4-61	3GPCH20SF	4-48
3GPCCDFRNYQ OFF	4-61	3GPCH21NUM	4-48
3GPCCDFRNYQ ON	4-61	3GPCH21SF	4-48
3GPCCDFTRC OFF	4-61	3GPCH22NUM	4-48
3GPCCDFTRC ON	4-61	3GPCH22SF	4-48
3GPCCDFTRG EXT	4-61	3GPCH23NUM	4-48
3GPCCDFTRG INT	4-61	3GPCH23SF	4-48
3GPCCDFTRGDLY	4-61	3GPCH24NUM	4-48
3GPCCDFTRGSLP FALL	4-61	3GPCH24SF	4-48
3GPCCDFTRGSLP RISE	4-61	3GPCH25NUM	4-48
3GPCCDFUNIT ABS	4-61	3GPCH25SF	4-48
3GPCCDFUNIT REL	4-61	3GPCH26NUM	4-48
3GPCCDFXMAX	4-61	3GPCH26SF	4-48
3GPCCDFXRNG	4-61	3GPCH27NUM	4-48
3GPCFER	4-49, 4-50, 4-51, 4-52	3GPCH27SF	4-48
3GPCFERPPM	4-49, 4-50, 4-51, 4-52	3GPCH28NUM	4-48
3GPCH10NUM	4-47	3GPCH28SF	4-48
3GPCH10SF	4-47	3GPCH29NUM	4-48
		3GPCH29SF	4-48
		3GPCH2NUM	4-46

4.1 GPIB Command Index

3GPCH2SF	4-46	3GPDNTHRSH	4-42, 4-44
3GPCH30NUM	4-48	3GPDNTRG EXT.....	4-41, 4-43
3GPCH30SF	4-48	3GPDNTRG INT.....	4-41, 4-43
3GPCH31NUM	4-48	3GPDNTRG SFN	4-41, 4-43
3GPCH31SF	4-48	3GPDNTRGDLY	4-41, 4-43
3GPCH3NUM	4-46	3GPDNTRGSLP FALL.....	4-41, 4-43
3GPCH3SF	4-46	3GPDNTRGSLP RISE	4-41, 4-43
3GPCH4NUM	4-46	3GPDPCCHNO	4-44, 4-45
3GPCH4SF	4-46	3GPDPCCHSF.....	4-44, 4-45
3GPCH5NUM	4-46	3GPDSPST	4-40
3GPCH5SF	4-46	3GPFMT GRP	4-40
3GPCH6NUM	4-46	3GPFMT NUM.....	4-40
3GPCH6SF	4-46	3GPFMT TBL.....	4-40
3GPCH7NUM	4-47	3GPGTYP CON	4-40
3GPCH7SF	4-47	3GPGTYP CONDOT	4-40
3GPCH8NUM	4-47	3GPGTYP CONLIN.....	4-40
3GPCH8SF	4-47	3GPGTYP CONLINDOT.....	4-40
3GPCH9NUM	4-47	3GPGTYP EVM	4-40
3GPCH9SF	4-47	3GPGTYP ICHEYE	4-40
3GPCPICHNO.....	4-42, 4-43	3GPGTYP IQCHEYE	4-40
3GPCPICHSF	4-42, 4-43	3GPGTYP MAGERR.....	4-40
3GPDEMOD.....	4-51, 4-53	3GPGTYP PHAERR	4-40
3GPDEMOSV.....	4-41	3GPGTYP QCHEYE.....	4-40
3GPDISP DUAL.....	4-40	3GPGTYP SCHPWR	4-40
3GPDISP SNGL	4-40	3GPIQOFS.....	4-49, 4-50, 4-51, 4-52
3GPDNFERR NORM.....	4-42	3GPMAG	4-49, 4-50, 4-51
3GPDNFERR PREC.....	4-42	3GPMBRCH I.....	4-46
3GPDNMCHNO.....	4-44	3GPMBRCH Q.....	4-46
3GPDNMCHSF	4-44	3GPMK	4-50, 4-51, 4-52
3GPDNMEASMD CONC.....	4-41	3GPMKCHIP.....	4-53
3GPDNMEASMD PREC	4-41	3GPMKCODE.....	4-50, 4-51, 4-52
3GPDNMSLOT	4-44	3GPMKDEG.....	4-53
3GPDNMSTFRM.....	4-44	3GPMKERR	4-53
3GPDNMSTSLT	4-42	3GPMKEVM.....	4-50, 4-51, 4-52
3GPDNMUNIT	4-42	3GPMKEVMQ	4-52
3GPDNPHASE INV	4-42, 4-44	3GPMKI.....	4-53
3GPDNPHASE NORM.....	4-42, 4-44	3GPMKPHSE	4-50
3GPDNPKCDE OFF	4-41	3GPMKPOW	4-50, 4-51, 4-52
3GPDNPKCDE ON.....	4-41	3GPMKPOWABS	4-50, 4-51, 4-52
3GPDNRATE 120K	4-42	3GPMKPOWABSQ	4-52
3GPDNRATE 15K	4-42	3GPMKPOWQ	4-52
3GPDNRATE 240K	4-42	3GPMKQ	4-53
3GPDNRATE 30K	4-42	3GPMKRHO	4-50, 4-51, 4-52
3GPDNRATE 480K	4-42		
3GPDNRATE 60K	4-42		
3GPDNRATE 7K5	4-42		
3GPDNRATE 960K	4-42		
3GPDNRATE ACT	4-42		
3GPDNRATE ACTN	4-42		
3GPDNSCNO	4-41, 4-43		
3GPDNSCNOHEX.....	4-41, 4-43		

3GPMKRHOQ.....	4-52	3GPPTTRGSLP RISE.....	4-59
3GPMKSCH.....	4-53	3GPPTUNIT ABS.....	4-58
3GPMKSCHPOW.....	4-53	3GPPTUNIT REL.....	4-58
3GPMKSCHPOWABS.....	4-53	3GPPTYRNG.....	4-58
3GPMKTAU.....	4-50	3GPPTYUPR.....	4-58
3GPMKTIME.....	4-50, 4-52	3GPRHO.....	4-49, 4-51
3GPMKTING.....	4-50, 4-52	3GPSCCD.....	4-49, 4-50
3GPMKTINGQ.....	4-52	3GPSCDEF DEF.....	4-41, 4-43
3GPMKTX256.....	4-50	3GPSCDEF UNDEF.....	4-41, 4-43
3GMLTNUM.....	4-46	3GPSCGRP.....	4-49, 4-50
3GPMOD.....	4-49, 4-50, 4-51, 4-52	3GPSCHPWR.....	4-49
3GPP.....	4-49	3GPSLOT.....	4-49, 4-50, 4-52
3GPPAGE.....	4-40	3GPSRCH.....	4-43
3GPPHSE.....	4-49, 4-50, 4-51	3GPSRCH PCPICH.....	4-41, 4-43
3GPPKCDE.....	4-49, 4-52	3GPSRCH SCH.....	4-41
3GPPKMAG.....	4-49, 4-50, 4-51	3GPSRCH SCHLONG.....	4-41, 4-43
3GPPKMOD.....	4-49, 4-50, 4-51, 4-52	3GPTAU.....	4-49, 4-50, 4-51, 4-52
3GPPKPHSE.....	4-49, 4-50, 4-51	3GPTAUCHIP.....	4-49, 4-50, 4-51, 4-52
3GPPRATIO.....	4-49, 4-50	3GPTRNSTM OFF.....	4-42
3GPPT.....	4-60	3GPTRNSTM ON.....	4-42
3GPPTGTYP AVG.....	4-59	3GPTURN OFF.....	4-41
3GPPTGTYP PK.....	4-59	3GPTURN ON.....	4-41
3GPPTMEASMD CONC.....	4-59	3GPUPFERR NORM.....	4-45
3GPPTMEASMD PREC.....	4-59	3GPUPFERR PREC.....	4-45
3GPPTMK1AVG.....	4-60	3GPUPMCHNO.....	4-45
3GPPTMK1PKF.....	4-60	3GPUPMCHSF.....	4-45
3GPPTMK2AVG.....	4-60	3GPUPMEASMD CONC.....	4-44
3GPPTMK2PKF.....	4-60	3GPUPMEASMD PREC.....	4-44
3GPPTMKR1.....	4-60	3GPUPMSLOT.....	4-46
3GPPTMKR2.....	4-60	3GPUPMSTFRM.....	4-46
3GPPTMKRATIO.....	4-60	3GPUPMSTSLT.....	4-45
3GPPTMLN.....	4-59	3GPUPMUNIT.....	4-45
3GPPTOMIT OFF.....	4-59	3GPUPPHASE INV.....	4-45, 4-46
3GPPTOMIT ON.....	4-59	3GPUPPHASE NORM.....	4-45, 4-46
3GPPTRNYQ OFF.....	4-59	3GPUPRATE 120K.....	4-45
3GPPTRNYQ ON.....	4-59	3GPUPRATE 15K.....	4-45
3GPPTTABLE1.....	4-60	3GPUPRATE 240K.....	4-45
3GPPTTABLE2.....	4-60	3GPUPRATE 30K.....	4-45
3GPPTTMP1.....	4-60	3GPUPRATE 480K.....	4-45
3GPPTTMP2.....	4-60	3GPUPRATE 60K.....	4-45
3GPPTTRG EXT.....	4-59	3GPUPRATE 960K.....	4-45
3GPPTTRG IF.....	4-59	3GPUPSCNO.....	4-44, 4-45
3GPPTTRG INT.....	4-59	3GPUPSCNOHEX.....	4-44, 4-45
3GPPTTRGDLY.....	4-59	3GPUPTHRSH.....	4-45, 4-46
3GPPTTRGLVL.....	4-59	3GPUPTRG EXT.....	4-44, 4-45
3GPPTTRGSLP FALL.....	4-59	3GPUPTRG INT.....	4-44, 4-45
		3GPUPTRGDLY.....	4-44, 4-45
		3GPUPTRGSLP FALL.....	4-44, 4-45

4.1 GPIB Command Index

3GPUPTRGSLP RISE.....	4-44, 4-45	DL0	4-64
3GPVWPT	4-40	DL1	4-64
3GPXSCL CODE	4-40	DL2	4-64
3GPXSCL TIME	4-40	DL3	4-64
3GPYSCL EVM	4-40	DL4	4-64
3GPYSCL POW	4-40	DTMAUTOLVL.....	4-30
3GPYSCL POWABS	4-40	DTMAVG.....	4-31
3GPYSCL RHO.....	4-40	DTMAVGCNT.....	4-31
AA.....	4-10	DTMAVGMD MAX	4-31
AD.....	4-64	DTMAVGMD NUMERIC.....	4-31
ALS OFF.....	4-15	DTMAVGMD POWER	4-31
ALS ON	4-15	DTMAVGMD TRACE	4-31
AS	4-11	DTMDET NEG.....	4-31
AT	4-10	DTMDET NRM.....	4-31
ATMIN	4-10	DTMDET POS	4-31
ATMIN OFF	4-10	DTMDET SMP.....	4-31
ATMIN ON.....	4-10	DTMFRMD CFSP.....	4-32
AUTOLVL.....	4-40, 4-54, 4-58, 4-61, 4-62	DTMFRMD STSP	4-32
AUTOWFL.....	4-16	DTMJJDG OFF.....	4-32
AVGTYP NORM	4-15	DTMJJDG ON	4-32
AVGTYP PEAK.....	4-15	DTMMEAS	4-32
BA.....	4-11	DTMMKRCLR.....	4-31
BBINPUT AC.....	4-15	DTMMKRCP.....	4-31
BBINPUT DC.....	4-15	DTMMKRED	4-31
CF.....	4-11	DTMREF MKR	4-32
CH.....	4-14	DTMREF MOD.....	4-32
CHEDDN1	4-14	DTMREFPWR.....	4-32
CHEDDN2.....	4-14	DTMRES ABS	4-32
CHEDDN3.....	4-14	DTMRES MKR	4-32
CHEDUP1	4-14	DTMRES REL.....	4-32
CHEDUP2	4-14	DTMRFACT.....	4-32
CHEDUP3	4-14	DTMSETSTD.....	4-32
CHSETSTD	4-15	DTMSYMRT.....	4-32
CHTBL1 DSBL	4-15	DTMTMPL OFF.....	4-30
CHTBL1 ENBL.....	4-15	DTMTMPL ON	4-30
CHTBL2 DSBL	4-15	DTMTMPLBTM	4-32
CHTBL2 ENBL.....	4-15	DTMTMPLCLR	4-31
CHTBL3 DSBL	4-15	DTMTMPLDX	4-30
CHTBL3 ENBL.....	4-15	DTMTMPLED.....	4-31
CLDC	4-15	DTMTMPLPW OFF.....	4-32
CLMODGAIN	4-15	DTMTMPLPW ON	4-32
COMMSYS 3GPP	4-10	DTMTMPLSX.....	4-30
DB	4-63	DTMTMPLSY.....	4-30
DC0.....	4-12	DTMUNIT DBM.....	4-32
DC1	4-12	DTMUNIT DBUV	4-32
DC2.....	4-12	DTMUNIT W	4-32
DEL.....	4-13	DTSAUTOLVL.....	4-27
DEL REG _nn.....	4-13	DTSAVG	4-28
DELSTBL	4-21	DTSAVGCNT	4-28
		DTSAVGMD MAX	4-28
		DTSAVGMD NUMERIC	4-28

DTSAVGMD POWER.....	4-28	FDPDIV P10DB	4-24
DTSAVGMD TRACE.....	4-28	FDPDIV P2DB	4-24
DTSDET NEG	4-28	FDPDIV P5DB	4-24
DTSDET NRM.....	4-28	FDPJDG OFF	4-25
DTSDET POS.....	4-28	FDPJDG ON	4-25
DTSDET SMP	4-28	FDPJDGLOW.....	4-25
DTSFRMD CFSP	4-29	FDPJDGUP.....	4-25
DTSFRMD STSP	4-29	FDPMEAS	4-25
DTSJDG OFF	4-28	FDPSETSTD	4-25
DTSJDG ON.....	4-28	FDPUNIT DBM	4-25
DTSMEAS.....	4-29	FDPUNIT DBUV	4-25
DTSMKRCLR.....	4-27	FDPUNIT W.....	4-25
DTSMKRCP.....	4-27	FDPWDO OFF	4-24
DTSMKRED	4-27	FDPWDO ON.....	4-24
DTSREF MKR	4-29	FDPWPOS	4-24
DTSREF MOD	4-29	FDPWWID	4-24
DTSREFPWR.....	4-29	FDSAUTOLVL	4-38
DTSRES ABS.....	4-29	FDSAVG	4-38
DTSRES MKR	4-29	FDSAVGCNT	4-38
DTSRES REL	4-29	FDSAVGMD MAX.....	4-38
DTSRFACT.....	4-29	FDSAVGMD POWER	4-38
DTSSETSTD	4-29	FDSAVGMD TRACE.....	4-38
DTSSYMRT	4-29	FDSCLR	4-38
DTSTMPL OFF.....	4-27	FDSCLP	4-38
DTSTMPL ON	4-27	FDSDET NEG	4-38
DTSTMPLBTM.....	4-28	FDSDET NRM	4-38
DTSTMPLCLR	4-27	FDSDET POS	4-38
DTSTMPLDX	4-27	FDSDET SMP	4-38
DTSTMPLD	4-27	FDSJDG OFF	4-39
DTSTMPLPW OFF.....	4-28	FDSJDG ON	4-39
DTSTMPLPW ON	4-28	FDSL.....	4-38
DTSTMPLSX	4-27	FDSMEAS	4-39
DTSTMPLSY	4-27	FDSPKMKY.....	4-39
DTSUNIT DBM	4-28	FDSPRE 16G.....	4-39
DTSUNIT DBUV	4-28	FDSPRE 36G.....	4-39
DTSUNIT W.....	4-28	FDSSETSTD	4-39
ENT.....	4-63	FDSSV	4-38
ERRNO.....	4-64	FDSTBL.....	4-38
FA	4-11	FDSTBLED	4-38
FB.....	4-11	FDSUNIT DBM	4-38
FDPAUTOLVL	4-23	FDSUNIT DBUV	4-38
FDPAVG	4-25	FDSUNIT W.....	4-38
FDPAVGCNT	4-25	FINPMD CHL	4-14
FDPAVGMD MAX.....	4-25	FINPMD FREQ.....	4-14
FDPAVGMD NUMERIC.....	4-25	GPHCHIP	4-54, 4-57
FDPAVGMD POWER	4-25	GPHI	4-54, 4-57
FDPAVGMD TRACE.....	4-25	GPHQ.....	4-54, 4-57
FDPDET NEG	4-25	GPHX.....	4-54, 4-57
FDPDET NRM	4-25	GPHY.....	4-54, 4-57
FDPDET POS	4-25	GZ.....	4-63
FDPDET SMP	4-25	HCOPY	4-10

4.1 GPIB Command Index

HZ	4-63	OORDET NRM	4-20
INPUT IQ	4-15	OORDET POS	4-20
INPUT RF	4-15	OORDET SMP	4-20
IP	4-12	OORDIV P10DB	4-19
KZ	4-63	OORDIV P2DB	4-19
LC	4-64	OORDIV P5DB	4-19
LINK DOWN	4-14	OORJDG OFF	4-20
LINK UP	4-14	OORJDG ON	4-20
MA	4-63	OORJDGUP	4-20
MEASMD FRAME	4-14	OORMEAS	4-20
MEASMD SLOT	4-14	OORSETSTD	4-20
MF	4-12	OORTRGDT	4-19
MFL	4-12	OORTRGLV L	4-19
MK	4-12	OORTRGPOS	4-19
MKBW	4-12	OORTRGSLP FALL	4-19
MKD	4-12	OORTRGSLP RISE	4-19
MKN	4-12	OORTRGSRC EXT	4-19
MKOFF	4-12	OORTRGSRC FREE	4-19
ML	4-12	OORTRGSRC IF	4-19
MO	4-12	OORTRGSRC VIDEO	4-19
MODTYP 3GPP	4-14	OORUNIT DBM	4-20
MS	4-63	OORUNIT DBUV	4-20
MV	4-63	OORUNIT W	4-20
MW	4-63	OORWDO OFF	4-19
MZ	4-63	OORWDO ON	4-19
OBWAUTOLVL	4-26	OORWOFPOS	4-19
OBWAVG	4-26	OORWOFWID	4-19
OBWAVGCNT	4-26	OORWONPOS	4-19
OBWAVGMD MAX	4-26	OORWONWID	4-19
OBWAVGMD NUMERIC	4-26	OPF	4-64
OBWAVGMD POWER	4-26	OPR	4-65
OBWAVGMD TRACE	4-26	OPREVT	4-65
OBWDET NEG	4-26	PCPICH	4-62
OBWDET NRM	4-26	PCPICHAVG	4-62
OBWDET POS	4-26	PCPICHFRERR	4-63
OBWDET SMP	4-26	PCPICHMSFRM	4-62
OBWJDG OFF	4-26	PCPICHPWAvg	4-62
OBWJDG ON	4-26	PCPICHPWMAX	4-63
OBWJDGLOW	4-26	PCPICHPWMIN	4-63
OBWJDGUP	4-26	PCPICHSCN	4-62
OBWMEAS	4-26, 4-27	PCPICHSCNHEX	4-62
OBWPER	4-26	PCPICHSRCHMD PCPICH	4-62
OBWSETSTD	4-26	PCPICHSRCHMD SCHLONG	4-62
OORAUTOLVL	4-19	PCPICHXPWR	4-63
OORAVG	4-20	PS	4-12
OORAVGCNT	4-20	QGTYP CON	4-55
OORAVGMD MAX	4-20	QPAVG	4-55
OORAVGMD NUMERIC	4-20	QPDPST	4-54
OORAVGMD POWER	4-20	QPFER	4-56
OORAVGMD TRACE	4-20	QPGTYP CONDOT	4-55
OORDET NEG	4-20	QPGTYP CONLIN	4-55

QPGTYP CONLINDOT.....	4-55	4-60, 4-61,
QPGTYP EVM.....	4-55	4-62
QPGTYP ICHEYE.....	4-55	
QPGTYP IQCHEYE.....	4-55	
QPGTYP MAGERR.....	4-55	
QPGTYP PHAERR.....	4-55	
QPGTYP QCHEYE.....	4-55	
QPIQOFS.....	4-56	
QPJDG.....	4-56	
QPLMJDG OFF.....	4-55	
QPLMJDG ON.....	4-55	
QPLMRHO.....	4-55	
QPMAG.....	4-56	
QPMKCHIP.....	4-56	
QPMKDEG.....	4-56	
QPMKERR.....	4-56	
QPMKI.....	4-56	
QPMKQ.....	4-56	
QPMOD.....	4-56	
QPMRNG.....	4-55	
QPPHSE.....	4-56	
QPRHO.....	4-56	
QPRNYQ OFF.....	4-55	
QPRNYQ ON.....	4-55	
QPSK.....	4-56	
QPTRG EXT.....	4-55	
QPTRG IF.....	4-55	
QPTRG INT.....	4-55	
QPTRGDLY.....	4-55	
QPTRGLVL.....	4-55	
QPTRGSLP FALL.....	4-55	
QPTRGSLP RISE.....	4-55	
RB.....	4-11	
RC.....	4-12	
RC REG_nn.....	4-12	
RCLTBL.....	4-21	
RL.....	4-11	
RO.....	4-14	
RQS.....	4-64	
S0.....	4-64	
S1.....	4-64	
S2.....	4-64	
SC.....	4-63	
SETFUNC CW.....	4-10	
SETFUNC TRAN.....	4-10	
SI.....	4-18, 4-20, 4-23, 4-25, 4-26, 4-29, 4-32, 4-35, 4-39, 4-49, 4-56, 4-58,	
SP.....	4-13	
SPR2AUTOLVL.....	4-35	
SPR2AVG.....	4-36	
SPR2AVGCNT.....	4-36	
SPR2AVGMD POWER.....	4-36	
SPR2CONV OFF.....	4-37	
SPR2CONV ON.....	4-37	
SPR2DET NEG.....	4-36	
SPR2DET NRM.....	4-36	
SPR2DET POS.....	4-36	
SPR2DET SMP.....	4-36	
SPR2FRMD CFSP.....	4-36	
SPR2FRMD STSP.....	4-36	
SPR2INTE.....	4-37	
SPR2JDG OFF.....	4-36	
SPR2JDG ON.....	4-36	
SPR2MEAS.....	4-37	
SPR2MKRCLR.....	4-36	
SPR2MKRCP.....	4-35	
SPR2MKRED.....	4-36	
SPR2OFSSP.....	4-37	
SPR2OFSSST.....	4-37	
SPR2PKMKY.....	4-37	
SPR2REF MKR.....	4-37	
SPR2REF MOD.....	4-37	
SPR2REFPWR.....	4-37	
SPR2RES ABS.....	4-36	
SPR2RES MKR.....	4-36	
SPR2RES REL.....	4-36	
SPR2SETSTD.....	4-37	
SPR2TMPL OFF.....	4-35	
SPR2TMPL ON.....	4-35	
SPR2TMPLBTM.....	4-36	
SPR2TMPLCLR.....	4-35	
SPR2TMPLCP.....	4-35	
SPR2TMPLDX.....	4-35	
SPR2TMPLIED.....	4-35	
SPR2TMPLPW OFF.....	4-36	
SPR2TMPLPW ON.....	4-36	
SPR2TMPLSX.....	4-35	
SPR2TMPLSY.....	4-35	
SPR2UNIT DBM.....	4-36	
SPR2UNIT DBUV.....	4-36	
SPR2UNIT W.....	4-36	
SPRAUTOLVL.....	4-33	
SPRAVG.....	4-33	
SPRAVGCNT.....	4-33	
SPRAVGMD MAX.....	4-34	
SPRAVGMD POWER.....	4-34	

4.1 GPIB Command Index

SPRAVGMD TRACE	4-34	TDPAVGMD TRACE.....	4-17
SPRDET NEG	4-34	TDPDET NEG.....	4-17
SPRDET NRM	4-34	TDPDET NRM.....	4-17
SPRDET POS	4-34	TDPDET POS.....	4-17
SPRDET SMP.....	4-34	TDPDET SMP.....	4-17
SPRFRMD CFSP.....	4-34	TDPDIV P10DB	4-16
SPRFRMD STSP	4-34	TDPDIV P2DB	4-16
SPRJDG OFF.....	4-34	TDPDIV P5DB	4-16
SPRJDG ON	4-34	TDPJDG OFF	4-18
SPRMEAS	4-35	TDPJDG ON.....	4-18
SPRMKRCLR	4-33	TDPJDGLOW	4-18
SPRMKRCP	4-33	TDPJDGUP	4-18
SPRMKRED.....	4-33	TDPMEAS.....	4-18
SPRPKMKY	4-35	TDPSETSTD	4-18
SPRREF MKR.....	4-35	TDPTMPL OFF.....	4-17
SPRREF MOD.....	4-35	TDPTMPL ON	4-17
SPRREFPWR	4-35	TDPTMPLBTM.....	4-18
SPRRES ABS	4-34	TDPTMPLCLR	4-17
SPRRES MKR.....	4-34	TDPTMPLED.....	4-17
SPRRES REL	4-34	TDPTMPLPW OFF.....	4-18
SPRSETSTD.....	4-35	TDPTMPLPW ON	4-18
SPRTMPL OFF	4-33	TDPTMPLSEL LOW	4-17
SPRTMPL ON	4-33	TDPTMPLSEL UP.....	4-17
SPRTMPLBTM.....	4-34	TDPTMPLSX	4-17
SPRTMPLCLR.....	4-33	TDPTMPLSY	4-17
SPRTMPLCP.....	4-33	TDPTRGDT.....	4-16
SPRTMPLDX.....	4-33	TDPTRGLVL	4-16
SPRTMPLED	4-33	TDPTRGPOS.....	4-16
SPRTMPLPW OFF	4-34	TDPTRGSLP FALL	4-16
SPRTMPLPW ON	4-34	TDPTRGSLP RISE	4-16
SPRTMPLSX.....	4-33	TDPTRGSRC EXT.....	4-16
SPRTMPLSY.....	4-33	TDPTRGSRC FREE.....	4-16
SPRUNIT DBM.....	4-34	TDPTRGSRC IF.....	4-16
SPRUNIT DBUV	4-34	TDPTRGSRC VIDEO.....	4-16
SPRUNIT W	4-34	TDPUNIT DBM	4-17
SPULVL	4-23	TDPUNIT DBUV	4-17
SPUR	4-23	TDPUNIT W.....	4-17
ST	4-11	TDPWDO OFF	4-16
STDTRGLVL	4-15	TDPWDO ON.....	4-16
STDTRGSRC ANLG	4-15	TDPWPOS.....	4-16
STDTRGSRC TTL	4-15	TDPWWID	4-16
SV	4-13	TDSAUTOLVL.....	4-21
SV REG_mn	4-13	TDSAVG	4-21
SVSTBL.....	4-21	TDSAVGCNT	4-21
SW	4-11	TDSAVGMD MAX	4-22
TDPAUTOLVL	4-16	TDSAVGMD NUMERIC	4-22
TDPAVG	4-17	TDSAVGMD POWER.....	4-22
TDPAVCNT	4-17	TDSAVGMD TRACE.....	4-22
TDPAVGMD MAX	4-17	TDSCLR	4-21
TDPAVGMD NUMERIC	4-17	TDSDET NEG.....	4-22
TDPAVGMD POWER.....	4-17	TDSDET NRM	4-22

TDSDET POS.....	4-22	TRGLVL.....	4-16
TDSDET SMP.....	4-22	TRGPOS.....	4-16
TDSJDG OFF.....	4-22	TRGSLP FALL.....	4-16
TDSJDG ON.....	4-22	TRGSLP RISE.....	4-16
TDSL.....	4-21	TRGSRC EXT.....	4-16
TDSMEAS.....	4-23	TRGSRC FREE.....	4-16
TDSMULTI.....	4-22	TRGSRC IF.....	4-16
TDSPKMKY.....	4-22	TRGSRC VIDEO.....	4-16
TDSPRE 16G.....	4-22	TRSPMD EXT.....	4-21
TDSPRE 36G.....	4-22	TRSPMD FREE.....	4-21
TDSRES PK.....	4-22	TRSPMD IF.....	4-21
TDSRES RMS.....	4-22	TRSPSLP FALL.....	4-21
TDSSETSTD.....	4-22	TRSPSLP RISE.....	4-21
TDSSV.....	4-21	TXAVG.....	4-58
TDSTBL.....	4-21	TXPWR.....	4-58
TDSTBLED.....	4-21	TXRNYQ OFF.....	4-58
TDSTBLF ABS.....	4-21	TXRNYQ ON.....	4-58
TDSTBLF REL.....	4-21	TXTRG EXT.....	4-58
TDSTRGDT.....	4-21	TXTRG INT.....	4-58
TDSTRGLVL.....	4-21	TXTRGDLY.....	4-58
TDSTRGPOS.....	4-21	TXTRGSLP FALL.....	4-58
TDSTRGSLP FALL.....	4-21	TXTRGSLP RISE.....	4-58
TDSTRGSLP RISE.....	4-21	US.....	4-63
TDSTRGSRC EXT.....	4-21	VA.....	4-11
TDSTRGSRC FREE.....	4-21	VB.....	4-11
TDSTRGSRC IF.....	4-21	WAVEFM.....	4-18
TDSUNIT DBM.....	4-22	XDB.....	4-12
TDSUNIT DBUV.....	4-22	XDL.....	4-12
TDSUNIT W.....	4-22	XDR.....	4-12
TGTDET NEG.....	4-24, 4-30		
TGTDET NRM.....	4-24, 4-30		
TGTDET POS.....	4-24, 4-30		
TGTDET SMP.....	4-24, 4-30		
TGTPOS.....	4-24, 4-30		
TGTSETUP OFF.....	4-23, 4-30		
TGTSETUP ON.....	4-23, 4-30		
TGTSRC EXT.....	4-24, 4-30		
TGTSRC TRG.....	4-24, 4-30		
TGTSWP OFF.....	4-24, 4-30		
TGTSWP ON.....	4-24, 4-30		
TGTTRG EXT.....	4-23, 4-30		
TGTTRG FREE.....	4-23, 4-30		
TGTTRG IF.....	4-23, 4-30		
TGTTRG VIDEO.....	4-23, 4-30		
TGTTRGDT.....	4-23, 4-30		
TGTTRGLVL.....	4-23, 4-30		
TGTTRGPOS.....	4-23, 4-30		
TGTTRGSLP FALL.....	4-23, 4-30		
TGTTRGSLP RISE.....	4-23, 4-30		
TGTWID.....	4-24, 4-30		
TRGDT.....	4-16		

4.2 GPIB Command Codes

4.2 GPIB Command Codes

The following table list the GPIB commands by function.

Table 4-1 Operating Mode

Function		Listener Code	Talker Request		Remarks
			Code	Output Format	
Operating mode	Spectrum analyzer mode	SETFUNC CW	SETFUNC?	0:Spectrum analyzer 1:TRANSIENT	
	TRANSIENT mode	SETFUNC TRAN			
Communication system	3GPP mode	COMMSYS 3GPP	COMMSYS?	9:3GPP	*1

*1: Listener code is available only when the analyzer is set to the CW mode. The codes within the talker request are available for both the CW and TRANSIENT modes.

Table 4-2 ATT Key (Attenuator)

Function		Listener Code	Talker Request		Remarks
			Code	Output Format	
Attenuator	AT	AT *	AT?	Level	
	ATT AUTO	AA	AA?	0: Manual 1: AUTO	
	Min. ATT	ATMIN *	ATMIN?	Level	
	Min. ATT ON OFF	ATMIN ON [*] ATMIN OFF	ATMINON?	0: OFF 1: ON	

Table 4-3 COPY Key (Hard copy)

Function		Listener Code	Talker Request		Remarks
			Code	Output Format	
Printer output File output	Execution of the command	HCOPY	-	-	

Table 4-4 COUPLE Key (Couple function)

Function		Listener Code	Talker Request		Remarks
			Code	Output Format	
Couple function	RBW	RB *	RB?	Frequency	
	RBW AUTO	BA	BA?	0:Manual 1:AUTO	
	VBW	VB *	VB?	Frequency	
	VBW AUTO	VA	VA?	0:Manual 1:AUTO	
	Sweep Time	SW * ST *	SW? ST?	Time	
	Sweep Time Auto	AS	AS?	0:Manual 1:AUTO	

Table 4-5 FREQ Key (Frequency)

Function		Listener Code	Talker Request		Remarks
			Code	Output Format	
Frequency	Center frequency	CF *	CF?	Frequency	
	Start frequency	FA *	FA?	Frequency	
	Stop frequency	FB *	FB?	Frequency	

Table 4-6 LEVEL Key (Reference Level)

Function		Listener Code	Talker Request		Remarks
			Code	Output Format	
Reference level		RL *	RL?	Level	

4.2 GPIB Command Codes

Table 4-7 MKR Key (Marker)

Function	Listener Code	Talker Request		Remarks
		Code	Output Format	
Marker	ΔMarker ON	MKD [*]	-	Frequency(Time)
	OFF	MKOFF MO	- -	- -
	Reading marker frequency (time)	-	MF?	Frequency(Time)
	Reading marker level	-	ML?	Level
	Reading marker frequency (time) and marker level	-	MFL?	Frequency(Time), Level
	Normal marker	MK [*] MKN [*]	- -	Frequency(Time)
	Peak search	PS	-	-
	X-dB Down			
	X-dB Down width	MKBW *	MKBW?	Level
	X-dB Down	XDB	-	-
	X-dB Down Left	XDL	-	-
	X-dB Down Right	XDR	-	-
	Display mode REL.	DC0	DC?	0: Relative mode
	ABS.L.	DC1		1: Absolute mode (Left side)
	ABS.R.	DC2		2: Absolute mode (Right side)

Table 4-8 PRESET Key (Initialization)

Function	Listener Code	Talker Request		Remarks
		Code	Output Format	
Preset	Instrument preset	IP	-	

Table 4-9 RCL Key (Recall)

Function	Listener Code	Talker Request		Remarks
		Code	Output Format	
Recall	RC REG_nn RC file name	- -	nn: 01 to 10 File name: Max.8 character	

Table 4-10 SAVE Key (Save)

Function		Listener Code	Talker Request		Remarks
			Code	Output Format	
Save	Save	SV REG_nn SV file name	- -	nn: 01 to 10 File name: Max.8 character	
	Deletion	DEL REG_nn DEL file name	- -	nn: 01 to 10 File name: Max.8 character	

Table 4-11 SPAN Key (Frequency span)

Function		Listener Code	Talker Request		Remarks
			Code	Output Format	
Frequency span		SP *	SP?	Frequency	

4.2 GPIB Command Codes

Table 4-12 TRANSIENT Key

Function		Listener Code	Talker Request		Remarks
			Code	Output Format	
STD Setup	Communication system 3GPP	MODTYP 3GPP	MODTYP?	0: 3GPP	
	Meas Mode SLOT FRAME	MEASMD SLOT MEASMD FRAME	MEASMD?	0: SLOT 1: FRAME	
	LINK UPLINK DOWNLINK	LINK UP LINK DOWN	LINK?	0: UPLINK 1: DOWNLINK	
	Offset Level	RO *	RO?	Level	
	Frequency setting mode Frequency input mode Channel input mode	FINPMD FREQ FINPMD CHL	FINPMD?	0: Frequency input 1: Channel input	
	Channel Setting	CH *	CH?	Integer (channel number)	
	Channel Editing Input #1 (UPLINK) Input #2 (UPLINK) Input #3 (UPLINK) Input #1 (DOWNLINK) Input #2 (DOWNLINK) Input #3 (DOWNLINK)	CHEDUP1 *,*,*,* CHEDUP2 *,*,*,* CHEDUP3 *,*,*,* CHEDDN1 *,*,*,* CHEDDN2 *,*,*,* CHEDDN3 *,*,*,*	CHEDUP1? CHEDUP2? CHEDUP3? CHEDDN1? CHEDDN2? CHEDDN3?	ch1,ch2,f1,f2,chof ch1,ch2,f1,f2,chof ch1,ch2,f1,f2,chof ch1,ch2,f1,f2,chof ch1,ch2,f1,f2,chof ch1,ch2,f1,f2,chof ch1:Start channel no. ch2:Stop channel no. f1:Base frequency (Hz) f2:Channel space (Hz) chof:Channel Offset	
				Units of frequency are necessary for f1 and f2.	

Table 4-12 TRANSIENT Key

Function	Listener Code	Talker Request		Remarks
		Code	Output Format	
STD Setup	Channel Table Enable/Disable selection			
	#1 ENABLE	CHTBL1 ENBL	CHTBL1?	0:Disable
	DISABLE	CHTBL1 DSBL		1:Enable
	#2 ENABLE	CHTBL2 ENBL	CHTBL2?	0:Disable
	DISABLE	CHTBL2 DSBL		1:Enable
	#3 ENABLE	CHTBL3 ENBL	CHTBL3?	0:Disable
	DISABLE	CHTBL3 DSBL		1:Enable
	Channel Copy from STD	CHSETSTD	-	-
	Input RF	INPUT RF	INPUT?	0:RF
	BASEBAND(I&Q)	INPUT IQ		1:IQ
	BaseBand Input AC	BBINPUT AC	BBINPUT?	0:AC
	DC	BBINPUT DC		1:DC
	Auto Level Setting Auto Level OFF	ALS OFF	ALS?	0:OFF
	Auto Level ON	ALS ON		1:ON
Average Type NORMAL	AVGTYP NORM	AVGTYP?	0:NORMAL	
PEAK	AVGTYP PEAK		1:PEAK	
EXT Trigger Source TTL	STDTRGSRC TTL	STDTRGSRC?	0:TTL	
ANALOG	STDTRGSRC ANLG		1:ANALOG	
EXT Trigger Level	STDTRGLVL *	STDTRGLVL?	Level (0.00 to 5.00V)	
DC CAL	CLDC	-	-	
Gain Cal	CLMODGAIN	-	-	

4.2 GPIB Command Codes

Table 4-12 TRANSIENT Key

Function	Listener Code	Talker Request		Remarks	
		Code	Output Format		
T-Domain Power	Auto Level Set	AUTOWFL TDPAUTOLVL	-	-	
	Trigger Setup				
	TriggerSource				
	FREERUN	TRGSRC FREE TDPTRGSRC FREE	TRGSRC? TDPTRGSRC?	0:FREERUN 1:VIDEO	
	VIDEO	TRGSRC VIDEO TDPTRGSRC VIDEO		2:IF 3:EXT	
	IF	TRGSRC IF TDPTRGSRC IF			
	EXT	TRGSRC EXT TDPTRGSRC EXT			
	Trigger Slope				
	+	TRGSLP RISE TDPTRGSLP RISE	TRGSLP? TDPTRGSLP?	0:- 1:+	
	-	TRGSLP FALL TDPTRGSLP FALL			
	Trigger Level	TRGLVL * TDPTRGLVL *	TRGLVL? TDPTRGLVL?	Integer(0 to 100)	
	Trigger Position	TRGPOS * TDPTRGPOS *	TRGPOS? TDPTRGPOS?	Integer(0 to 100)	
	Delay Time	TRGDT * TDPTRGDT *	TRGDT? TDPTRGDT?	Time	
	Window Setup				
Window					
ON	TDPWDO ON	TDPWDO?	0:OFF		
OFF	TDPWDO OFF		1:ON		
Window Position	TDPWPOS *	TDPWPOS?	Time		
Window Width	TDPWWID *	TDPWWID?	Time		
Y Scale					
10dB/div	TDPDIV P10DB	TDPDIV?	0:10dB/div		
5dB/div	TDPDIV P5DB		1: 5dB/div		
2dB/div	TDPDIV P2DB		2: 2dB/div		

Table 4-12 TRANSIENT Key

Function	Listener Code	Talker Request		Remarks	
		Code	Output Format		
T-Domain Power	Average Times	TDPAVGCNT *	TDPAVGCNT?	Integer (1:OFF, 2 to 999)	*1
		TDPAVG *	TDPAVG?	Integer (1:OFF, 2 to 999)	
	Average Mode				
	TRACE AVG	TDPAVGMD TRACE	TDPAVGMD?	0: Trace Avg	
	MAX HOLD	TDPAVGMD MAX		1: Max Hold	
	POWER AVG	TDPAVGMD POWER		2: Power Avg	
	NUMERIC	TDPAVGMD NUMERIC		3: Numeric	
	Template				
	Template				
	ON	TDPTMPL ON	TDPTMPL?	0:OFF	
OFF	TDPTMPL OFF		1:ON		
Template Shift					
Shift X	TDPTMPLSX *	TDPTMPLSX?	Time		
Shift Y	TDPTMPLSY *	TDPTMPLSY?	Level		
Template Edit					
Template	TDPTMPLSEL UP	TDPTMPLSEL?	0:UP		
UP/LOW Selection	TDPTMPLSEL LOW		1:LOW		
Template	TDPTMPLED *,*	-	t1,l1		
Data Input			t1:Time l1:Level (dBm/W/dBμV)		
Init Table	TDPTMPLCLR	-	-		
Parameter Setup					
Detector					
Normal	TDPDET NRM	TDPDET?	0:Normal		
Posi	TDPDET POS		1:Posi		
Nega	TDPDET NEG		2:Nega		
Sample	TDPDET SMP		3:Sample		
Display Unit					
dBm	TDPUNIT DBM	TDPUNIT?	0:dBm		
W	TDPUNIT W		1:W		
dBμV	TDPUNIT DBUV		2:dBμV		

*1: Average Mode is set to POWER AVG.

4.2 GPIB Command Codes

Table 4-12 TRANSIENT Key

Function		Listener Code	Talker Request		Remarks
			Code	Output Format	
T-Domain Power	Template Couple to Power				
	ON	TDPTMPLPW ON	TDPTMPLPW?	0:OFF	
	OFF	TDPTMPLPW OFF		1:ON	
	Template Limit	TDPTMPLBTM *	TDPTMPLBTM?	Level (dBm/W/dBμV)	
	Judgement				
	ON	TDPJDG ON	TDPJDG?	0:OFF	
	OFF	TDPJDG OFF		1:ON	
	Upper Limit	TDPJDGUP *	TDPJDGUP?	Level	
	Lower Limit	TDPJDGLOW *	TDPJDGLOW?	Level	
	Set to STD	TDPSETSTD	-	-	
	Starts measurement				
	T-Domain Power	WAVEFM TDPMEAS	-	-	
Starts measurement in the same mode	SI	-	-		
Measurement results					
T-Domain Power	-	TDPMEAS?	l1, j1 l1:Level (dBm/W/dBμV) j1:Integer (0:FAIL,1:PASS, -1:Judgement OFF)		

Table 4-12 TRANSIENT Key

Function	Listener Code	Talker Request		Remarks	
		Code	Output Format		
ON/OFF Ratio	Auto Level Set	OORAUTOLVL	-	-	
	Trigger Setup				
	Trigger Source				
	FREERUN	OORTRGSRC FREE	OORTRGSRC?	0:FREERUN	
	VIDEO	OORTRGSRC VIDEO		1:VIDEO	
	IF	OORTRGSRC IF		2:IF	
	EXT	OORTRGSRC EXT		3:EXT	
	Trigger Slope				
	+	OORTRGSLP RISE	OORTRGSLP?	0:-	
	-	OORTRGSLP FALL		1:+	
	Trigger Level	OORTRGLVL*	OORTRGLVL?	Integer(0 to 100)	
	Trigger Position	OORTRGPOS *	OORTRGPOS?	Integer(0 to 100)	
	Delay Time	OORTRGDT *	OORTRGDT?	Time	
	Window Setup				
	Window				
	ON	OORWDO ON	OORWDO?	0:OFF	
	OFF	OORWDO OFF		1:ON	
	ON Position	OORWONPOS *	OORWONPOS?	Time	
	ON Width	OORWONWID *	OORWONWID?	Time	
	OFF Position	OORWOFPOS *	OORWOFPOS?	Time	
OFF Width	OORWOFWID *	OORWOFWID?	Time		
Y Scale					
10dB/div	OORDIV P10DB	OORDIV?	0:10dB/div		
5dB/div	OORDIV P5DB		1:5dB/div		
2dB/div	OORDIV P2DB		2:2dB/div		

4.2 GPIB Command Codes

Table 4-12 TRANSIENT Key

Function		Listener Code	Talker Request		Remarks
			Code	Output Format	
ON/OFF Ratio	Average Times	OORAVGCNT *	OORAVGCNT?	Integer (1:OFF, 2 to 999)	*1
		OORAVG *	OORAVG?	Integer (1:OFF, 2 to 999)	
	Average Mode				
	TRACE AVG	OORAVGMD TRACE	OORAVGMD?	0: Trace Avg	
	MAX HOLD	OORAVGMD MAX		1: Max Hold	
	POWER AVG	OORAVGMD POWER		2: Power Avg	
	NUMERIC	OORAVGMD NUMERIC		3: Numeric	
	Parameter Setup				
	Detector				
	Normal	OORDET NRM	OORDET?	0:Normal	
	Posi	OORDET POS		1:Posi	
	Nega	OORDET NEG		2:Nega	
Sample	OORDET SMP		3:Sample		
Display Unit					
dBm	OORUNIT DBM	OORUNIT?	0:dBm		
W	OORUNIT W		1:W		
dBµV	OORUNIT DBUV		2:dBµV		
Judgement					
ON	OORJDG ON	OORJDG?	0:OFF		
OFF	OORJDG OFF		1:ON		
Upper Limit	OORJDGUP *	OORJDGUP?	Level		
Set to STD	OORSETSTD	-	-		
Starts measurement					
ON/OFF Ratio	OORMEAS	-	-		
Starts measurement in the same mode	SI	-	-		
Measurement results					
ON/OFF Ratio	-	OORMEAS?	l1,l2,d1,j1 l1:ON Level (dBm/W/dBµV) l2:OFF Level (dBm/W/dBµV) d1:ON/OFF Ratio (dB) j1:Integer (0:FAIL,1:PASS, -1:Judgement OFF)		

*1: Average Mode is set to NUMERIC.

Table 4-12 TRANSIENT Key

Function	Listener Code	Talker Request		Remarks	
		Code	Output Format		
T-Domain Spurious	Auto Level Set	TDSAUTOLVL	-	-	
	Trigger Setup				
	Trigger Source				
	FREERUN	TDSTRGSRC FREE TRSPMD FREE	TDSTRGSRC? TRSPMD?	0:FREERUN 2:IF	
	IF	TDSTRGSRC IF TRSPMD IF		3:EXT	
	EXT	TDSTRGSRC EXT TRSPMD EXT			
	Trigger Slope				
	+	TDSTRGSLP RISE TRSPSLP RISE	TDSTRGSLP? TRSPSLP?	0: - 1: +	
	-	TDSTRGSLP FALL TRSPSLP FALL			
	Trigger Level	TDSTRGLVL *	TDSTRGLVL?	Integer(0 to 100)	
	Trigger Position	TDSTRGPOS *	TDSTRGPOS?	Integer(0 to 100)	
	Delay Time	TDSTRGDT *	TDSTRGDT?	Time	
	Table				
	Table No. 1/2/3	TDSTBL *	TDSTBL?	Integer(1 to 3)	
	Table Edit	TDSTBLED *,*	-	f1,l1 f1:Frequency l1:Limit Level	
	Load Table	TDSL D	-	-	
	Load Table 1/2/3	RCLTBL *	-	Integer(1 to 3)	
	Save Table	TDSSV	-	-	
	Save Table 1/2/3	SVSTBL *	-	Integer(1 to 3)	
	Init Table	TDSCLR DELSTBL	-	-	
	Table Freq. Input				
	ABS	TDSTBLF ABS	TDSTBLF?	0:ABS	
	REL	TDSTBLF REL		1:REL	
Average Times	TDSAVGCNT *	TDSAVGCNT?	Integer (1:OFF, 2 to 999)		
	TDSAVG *	TDSAVG?	Integer (1:OFF, 2 to 999)	*1	

*1: When Detector is set to Positive, Average Mode is set to MAX HOLD. When Detector is set to something other than Positive, Average Mode is set to TRACE AVG.

4.2 GPIB Command Codes

Table 4-12 TRANSIENT Key

Function		Listener Code	Talker Request		Remarks
			Code	Output Format	
T-Domain Spurious	Average Mode				
	TRACE AVG	TDSAVGMD TRACE	TDSAVGMD?	0: Trace Avg	
	MAX HOLD	TDSAVGMD MAX		1: Max Hold	
	POWER AVG	TDSAVGMD POWER		2: Power Avg	
	NUMERIC	TDSAVGMD NUMERIC		3: Numeric	
	Parameter Setup				
	Detector				
	Normal	TDSDET NRM	TDSDET?	0:Normal	
	Posi	TDSDET POS		1:Posi	
	Nega	TDSDET NEG		2:Nega	
	Sample	TDSDET SMP		3:Sample	
	Display Unit				
	dBm	TDSUNIT DBM	TDSUNIT?	0:dBm	
W	TDSUNIT W		1:W		
dB μ V	TDSUNIT DBUV		2:dB μ V		
Judgement					
ON	TDSJDG ON	TDSJDG?	0:OFF		
OFF	TDSJDG OFF		1:ON		
Result					
Peak	TDSRES PK	TDSRES?	0:Peak		
RMS	TDSRES RMS		1:RMS		
Multiplier	TDSMULTI *	TDSMULTI?	Real Number		
Peak MKR Y-Delta	TDSPKMKY *	TDSPKMKY?	Real Number		
Preselector 1.6G	TDSPRE 16G	TDSPRE?	0:1.6G		
3.6G	TDSPRE 36G		1:3.6G		
Set to Default	TDSSETSTD	-	-		

Table 4-12 TRANSIENT Key

Function		Listener Code	Talker Request		Remarks
			Code	Output Format	
T-Domain Spurious	Starts measurement Spurious	TDSMEAS SPUR	-	-	
	Starts measurement in the same mode	SI	-	-	
	Measurement results Spurious	-	TDSMEAS? SPULVL?	n<CR+LF>+f1,l1,j1< CR+LF>..... +fn,ln,jn<CR+LF> n:Amount (Integer) fn:Frequency ln:Level (dBm/W/dBμV) jn:Integer (0:FAIL,1:PASS, -1:Judgement OFF) n<CR+LF>+f1,l1<CR +LF> +fn,ln<CR+LF> n:Amount (Integer) fn:Frequency ln:Level (dBm)	
F-Domain Power	Auto Level Set	FDPAUTOLVL	-	-	
	Gate Setup				
	ON	TGTSETUP ON	TGTSETUP?	0:OFF	
	OFF	TGTSETUP OFF		1:ON	
	Trigger Source				
	FREERUN	TGTTRG FREE	TGTTRG?	0:FREERUN	
	VIDEO	TGTTRG VIDEO		1:VIDEO	
	IF	TGTTRG IF		2:IF	
EXT	TGTTRG EXT		3:EXT		
Trigger Slope					
-	TGTTRGSLP FALL	TGTTRGSLP?	0:-		
+	TGTTRGSLP RISE		1:+		
Trigger Level	TGTTRGLVL *	TGTTRGLVL?	Integer (0 to 100)		
Trigger Position	TGTTRGPOS *	TGTTRGPOS?	Integer (0 to 100)		
Delay Time	TGTTRGDT *	TGTTRGDT?	Time		

4.2 GPIB Command Codes

Table 4-12 TRANSIENT Key

Function	Listener Code	Talker Request		Remarks
		Code	Output Format	
F-Domain Power	Gate Source Trigger	TGTSRC TRG	TGTSRC?	0:Trigger
	Ext Gate	TGTSRC EXT		1:EXT
	Gate Position	TGTPOS *	TGTPOS?	Time
	Gate Width	TGTWID *	TGTWID?	Time
	Detector			
	Normal	TGTDET NRM	TGTDET?	0:Normal
	Posi	TGTDET POS		1:Posi
	Nega	TGTDET NEG		2:Nega
	Sample	TGTDET SMP		3:Sample
	Gated Sweep ON/OFF			
	ON	TGTSWP ON	TGTSWP?	0:OFF
	OFF	TGTSWP OFF		1:ON
	Window Setup			
Window				
ON	FDPWDO ON	FDPWDO?	0:OFF	
OFF	FDPWDO OFF		1:ON	
Window Position	FDPWPOS *	FDPWPOS?	Frequency	
Window Width	FDPWWID *	FDPWWID?	Frequency	
Y Scale				
10dB/div	FDPDIV P10DB	FDPDIV?	0:10dB/div	
5dB/div	FDPDIV P5DB		1: 5dB/div	
2dB/div	FDPDIV P2DB		2: 2dB/div	

Table 4-12 TRANSIENT Key

Function		Listener Code	Talker Request		Remarks
			Code	Output Format	
F-Domain Power	Average Times	FDPAVGCNT *	FDPAVGCNT?	Integer (1:OFF, 2 to 999)	*1
		FDPAVG *	FDPAVG?	Integer (1:OFF, 2 to 999)	
	Average Mode				
	TRACE AVG	FDPAVGMD TRACE	FDPAVGMD?	0: Trace Avg	
	MAX HOLD	FDPAVGMD MAX		1: Max Hold	
	POWER AVG	FDPAVGMD POWER		2: Power Avg	
	NUMERIC	FDPAVGMD NUMERIC		3: Numeric	
	Parameter Setup				
	Detector				
	Normal	FDPDET NRM	FDPDET?	0:Normal	
	Posi	FDPDET POS		1:Posi	
	Nega	FDPDET NEG		2:Nega	
	Sample	FDPDET SMP		3:Sample	
	Display Unit				
dBm	FDPUNIT DBM	FDPUNIT?	0:dBm		
W	FDPUNIT W		1:W		
dB μ V	FDPUNIT DBUV		2:dB μ V		
Judgement					
ON	FDPJDG ON	FDPJDG?	0:OFF		
OFF	FDPJDG OFF		1:ON		
Upper Limit	FDPJDGUP *	FDPJDGUP?	Level (dBm/W/dB μ V)		
Lower Limit	FDPJDGLOW *	FDPJDGLOW?	Level (dBm/W/dB μ V)		
Set to STD	FDPSETSTD	-	-		
Starts measurement					
F-Domain Power	FDPMEAS	-	-		
Starts measurement in the same mode	SI	-	-		
Measurement results					
F-Domain Power	-	FDPMEAS?	l1, j1 l1:Level (dBm/W/dB μ V) j1:Integer (0:FAIL,1:PASS, -1:Judgement OFF)		

*1: Average Mode is set to POWER AVG.

4.2 GPIB Command Codes

Table 4-12 TRANSIENT Key

Function		Listener Code	Talker Request		Remarks
			Code	Output Format	
OBW	Auto Level Set	OBWAUTOLVL	-	-	*1
	OBW%	OBWPER *	OBWPER?	Real Number (0.5 to 99.5)	
	Average Times	OBWAVGCNT *	OBWAVGCNT?	Integer (1:OFF, 2 to 999)	
		OBWAVG *	OBWAVG?	Integer (1:OFF, 2 to 999)	
	Average Mode TRACE AVG MAX HOLD POWER AVG NUMERIC	OBWAVGMD TRACE OBWAVGMD MAX OBWAVGMD POWER OBWAVGMD NUMERIC	OBWAVGMD?	0: Trace Avg 1: Max Hold 2: Power Avg 3: Numeric	
	Parameter Setup				
	Detector				
	Normal	OBWDET NRM	OBWDET?	0:Normal	
	Posi	OBWDET POS		1:Pos	
	Nega	OBWDET NEG		2:Nega	
	Sample	OBWDET SMP		3:Sample	
	Judgement				
	ON	OBWJDG ON	OBWJDG?	0:OFF	
OFF	OBWJDG OFF		1:ON		
Upper Limit	OBWJDGUP *	OBWJDGUP?	Frequency		
Lower Limit	OBWJDGLOW *	OBWJDGLOW?	Frequency		
Set to STD	OBWSETSTD	-	-		
Starts measurement					
OBW	OBWMEAS	-	-		
Starts measurement in the same mode	SI	-	-		

*1: When Detector is set to Positive, Average Mode is set to MAX HOLD. When Detector is set to something other than Positive, Average Mode is set to TRACE AVG.

Table 4-12 TRANSIENT Key

Function		Listener Code	Talker Request		Remarks
			Code	Output Format	
OBW	Measurement results OBW	-	OBWMEAS?	f1,f2,f3,j1 f1:OBW frequency f2:Lower side frequency f3:Higher side frequency j1: Integer (0: FAIL, 1: PASS, -1: Judgement OFF)	
Due to Transient	Auto Level Set	DTSAUTOLVL	-	-	
	Template				
	Template				
	ON	DTSTMPL ON	DTSTMPL?	0: OFF	
	OFF	DTSTMPL OFF		1: ON	
	Template Shift				
	Shift X	DTSTMPLSX *	DTSTMPLSX?	Frequency	
	Shift Y	DTSTMPLSY *	DTSTMPLSY?	Level	
	Margin delta X	DTSTMPLDX *	DTSTMPLDX?	Frequency (0:OFF)	
	Data Input	DTSTMPLD **,*	-	f1,l1 f1: Frequency l1: Level (dBm/W/dBμV)	
Init Table	DTSTMPLCLR	-	-		
Marker Edit					
Copy from STD	DTSMKRCP	-	-		
Data Input	DTSMKRED **,**,*	-	d1,f1,f2,l1 d1: (0:Normal 1: Integral 2:√Nyquist) f1: Offset frequency f2: Bandwidth l1: Limit Level	Set the reference bandwidth to f2, after initializing the table.	
Init Table	DTSMKRCLR	-	-		

4.2 GPIB Command Codes

Table 4-12 TRANSIENT Key

Function	Listener Code	Talker Request		Remarks	
		Code	Output Format		
Due to Transient	Average Times	DTSAVGCNT *	DTSAVGCNT?	Integer (1:OFF, 2 to 999)	*1
		D TSAVG *	D TSAVG?	Integer (1:OFF, 2 to 999)	
	Average Mode				
	TRACE AVG	D TSAVGMD TRACE	D TSAVGMD?	0: Trace Avg	
	MAX HOLD	D TSAVGMD MAX		1: Max Hold	
	POWER AVG	D TSAVGMD POWER		2: Power Avg	
	NUMERIC	D TSAVGMD NUMERIC		3: Numeric	
	Parameter Setup				
Detector					
Normal	D TSDDET NRM	D TSDDET?	0: Normal		
Posi	D TSDDET POS		1: Posi		
Nega	D TSDDET NEG		2: Nega		
Sample	D TSDDET SMP		3: Sample		
Display Unit					
dBm	D TSUNIT DBM	D TSUNIT?	0: dBm		
W	D TSUNIT W		1: W		
dB μ V	D TSUNIT DBUV		2: dB μ V		
Template Couple to Power					
ON	D TSTMPLPW ON	D TSTMPLPW?	0: OFF		
OFF	D TSTMPLPW OFF		1: ON		
Template Limit	D TSTMPLBTM *	D TSTMPLBTM?	Level (dBm/W/dB μ V)		
Judgement					
ON	D TSDJDG ON	D TSDJDG?	0: OFF		
OFF	D TSDJDG OFF		1: ON		

*1: When Detector is set to Positive, Average Mode is set to MAX HOLD. When Detector is set to something other than Positive, Average Mode is set to TRACE AVG.

Table 4-12 TRANSIENT Key

Function		Listener Code	Talker Request		Remarks
			Code	Output Format	
Due to Transient	Freq. Setting CFSP STSP	DTSFRMD CFSP DTSFRMD STSP	DTSFRMD?	0: Center/Span Mode 1: Start/Stop Mode	
	Result ABS REL MKR	DTSRES ABS DTSRES REL DTSRES MKR	DTSRES?	0: Absolute 1: Relative 2: Marker	
	Ref Power MKR MOD	DTSREF MKR DTSREF MOD	DTSREF?	0: Reference Marker 1: Modulation	
	Symbol Rate 1/T	DTSSYMRT *	DTSSYMRT?	Frequency	
	Rolloff Factor	DTSRFACT *	DTSRFACT?	Real Number	
	Set to STD	DTSSETSTD	-	-	
	Starts measurement Due to Transient	DTSMEAS	-	-	
	Starts measurement in the same mode	SI	-	-	
	Measurement results Due to Transient	-	DTSMEAS?	n<CR+LF>+d1,j1<CR+LF> +dn,jn<CR+LF> n: Amount(Integer) dn: Power jn: Integer (0: FAIL, 1: PASS, -1: Judgement OFF)	
	Ref. Power	-	DTSREFPWR?	Level	

4.2 GPIB Command Codes

Table 4-12 TRANSIENT Key

Function	Listener Code	Talker Request		Remarks	
		Code	Output Format		
Due to Modulation	Auto Level Set	DTMAUTOLVL	-	-	
	Gate Setup				
	ON	TGTSETUP ON	TGTSETUP?	0:OFF	
	OFF	TGTSETUP OFF		1:ON	
	Trigger Source				
	FREERUN	TGTTRG FREE	TGTTRG?	0: FREERUN	
	VIDEO	TGTTRG VIDEO		1: VIDEO	
	IF	TGTTRG IF		2: IF	
	EXT	TGTTRG EXT		3: EXT	
	Trigger Slope				
	-	TGTTRGSLP FALL	TGTTRGSLP?	0: -	
	+	TGTTRGSLP RISE		1: +	
	Trigger Level	TGTTRGLVL *	TGTTRGLVL?	Integer (0 to 100)	
	Trigger Position	TGTTRGPOS *	TGTTRGPOS?	Integer (0 to 100)	
	Delay Time	TGTTRGDT *	TGTTRGDT?	Time	
	Gate Source				
	Trigger	TGTSRC TRG	TGTSRC?	0: Trigger	
	Ext Gate	TGTSRC EXT		1: EXT	
	Gate Position	TGTPOS *	TGTPOS?	Time	
	Gate Width	TGTWID *	TGTWID?	Time	
Detector					
Normal	TGTDET NRM	TGTDET?	0: Normal		
Posi	TGTDET POS		1: Posi		
Nega	TGTDET NEG		2: Nega		
Sample	TGTDET SMP		3: Sample		
Gated Sweep ON/OFF					
ON	TGTSWP ON	TGTSWP?	0: OFF		
OFF	TGTSWP OFF		1: ON		
Template					
Template					
ON	DTMTMPL ON	DTMTMPL?	0: OFF		
OFF	DTMTMPL OFF		1:ON		
Template Shift					
Shift X	DTMTMPLSX *	DTMTMPLSX?	Frequency		
Shift Y	DTMTMPLSY *	DTMTMPLSY?	Level		
Margin delta X	DTMTMPLDX *	DTMTMPLDX?	Frequency(0:OFF)		

Table 4-12 TRANSIENT Key

Function		Listener Code	Talker Request		Remarks
			Code	Output Format	
Due to Modulation	Data Input	DTMTMPLED *,*	-	f1,l1 f1: frequency l1: Level (dBm/W/dBμV)	Set the reference bandwidth to f2, after initializing the table.
	Init Table	DTMTMPLCLR	-	-	
	Marker Edit				
	Copy from STD	DTMMKRCP	-	-	
	Data Input	DTMMKRED *,*,*,*	-	d1,f1,f2,l1 d1: (0:Normal 1: Integral 2:√Nyquist)) f1: Offset frequency f2: Bandwidth l1: Limit Level	
	Init Table	DTMMKRCLR	-	-	
	Average Times	DTMAVGCNT * DTMAVG *	DTMAVGCNT? DTMAVG?	Integer (1:OFF, 2 to 999) Integer (1:OFF, 2 to 999)	*1
	Average Mode	DTMAVGMD TRACE DTMAVGMD MAX DTMAVGMD POWER DTMAVGMD NUMERIC	DTMAVGMD?	0: Trace Avg 1: Max Hold 2: Power Avg 3: Numeric	
	Parameter Setup				
	Detector	DTMDET NRM DTMDET POS DTMDET NEG DTMDET SMP	DTMDET?	0: Normal 1: Posi 2: Nega 3: Sample	

*1: When Detector is set to Positive, Average Mode is set to MAX HOLD. When Detector is set to something other than Positive, Average Mode is set to TRACE AVG.

4.2 GPIB Command Codes

Table 4-12 TRANSIENT Key

Function		Listener Code	Talker Request		Remarks
			Code	Output Format	
Due to Modulation	Display Unit dBm W dB μ V	DTMUNIT DBM DTMUNIT W DTMUNIT DBUV	DTMUNIT?	0: dBm 1: W 2: dB μ V	
	Template Couple to Power ON OFF	DTMTMPLPW ON DTMTMPLPW OFF	DTMTMPLPW?	0: OFF 1: ON	
	Template Limit	DTMTMPLBTM *	DTMTMPLBTM?	Level (dBm/W/dB μ V)	
	Judgement ON OFF	DTMJJDG ON DTMJJDG OFF	DTMJJDG?	0: OFF 1: ON	
	Freq. Setting CFSP STSP	DTMFRMD CFSP DTMFRMD STSP	DTMFRMD?	0: Center/Span Mode 1: Start/Stop Mode	
	Result ABS REL MKR	DTMRES ABS DTMRES REL DTMRES MKR	DTMRES?	0: Absolute 1: Relative 2: Marker	
	Ref Power MKR MOD	DTMREF MKR DTMREF MOD	DTMREF?	0: Reference Marker 1: Modulation	
	Symbol Rate 1/T	DTMSYMRT *	DTMSYMRT?	Frequency	
	Rolloff Factor	DTMRFACT *	DTMRFACT?	Real Number	
	Set to STD	DTMSETSTD	-	-	
	Start measurement Due to Modulation	DTMMEAS	-	-	
	Starts measurement in the same mode	SI	-	-	
	Measurement results Due to Modulation	-	DTMMEAS?	n<CR+LF>+d1, j1<CR+LF>+dn,jn<CR+LF> n: Amount (Integer) dn: Power jn: Integer (0: FAIL, 1: PASS, -1: Judgement OFF)	
	Ref. Power	-	DTMREFPWR?	Level	

Table 4-12 TRANSIENT Key

Function	Listener Code	Talker Request		Remarks	
		Code	Output Format		
Inband Spurious (1)	Auto Level Set	SPRAUTOLVL	-	-	
	Template				
	Template				
	ON	SPRTMPL ON	SPRTMPL?	0: OFF	
	OFF	SPRTMPL OFF		1: ON	
	Template Shift				
	Shift X	SPRTMPLSX *	SPRTMPLSX?	Frequency	
	Shift Y	SPRTMPLSY *	SPRTMPLSY?	Level	
	Margin delta X	SPRTMPLDX *	SPRTMPLDX?	Frequency (0:OFF)	
	Copy from STD	SPRTMPLCP	-	-	
	Data Input	SPRTMPLED *,*	-	f1,l1 f1: Frequency l1: Level (dBm/W/dBμV)	
	Init Table	SPRTMPLCLR	-	-	
	Marker Edit				
	Copy from STD	SPRMKRCP	-	-	
Data Input	SPRMKRED *,*,*,*	-	d1, f1,f2,l1 d1: (0: Peak, 1: Integral) f1: Start Frequency f2: Stop Frequency l1: Limit Level	Set the reference bandwidth to f2, after initializing the table.	
Init Table	SPRMKRCLR	-	-		
Average Times	SPRAVGCNT *	SPRAVGCNT?	Integer (1:OFF, 2 to 999)		
	SPRAVG *	SPRAVG?	Integer (1:OFF, 2 to 999)	*1	

*1: When Detector is set to Positive, Average Mode is set to MAX HOLD. When Detector is set to something other than Positive, Average Mode is set to TRACE AVG.

4.2 GPIB Command Codes

Table 4-12 TRANSIENT Key

Function	Listener Code	Talker Request		Remarks
		Code	Output Format	
Inband Spurious (1)	Average Mode TRACE AVG MAX HOLD POWER AVG	SPRAVGMD TRACE SPRAVGMD MAX SPRAVGMD POWER	SPRAVGMD?	0: Trace Avg 1: Max Hold 2: Power Avg
	Parameter Setup			
	Detector			
	Normal	SPRDET NRM	SPRDET?	0: Normal
	Posi	SPRDET POS		1: Posi
	Nega	SPRDET NEG		2: Nega
	Sample	SPRDET SMP		3: Sample
	Display Unit			
	dBm	SPRUNIT DBM	SPRUNIT?	0: dBm
	W	SPRUNIT W		1: W
dBµV	SPRUNIT DBUV	2: dBµV		
Template Couple to Power				
ON	SPRTMPLPW ON	SPRTMPLPW?	0: OFF	
OFF	SPRTMPLPW OFF		1: ON	
Template Limit	SPRTMPLBTM *	SPRTMPLBTM?	Level (dBm/W/dBµV)	
Judgement				
ON	SPRJDG ON	SPRJDG?	0: OFF	
OFF	SPRJDG OFF		1: ON	
Freq. Setting				
CFSP	SPRFRMD CFSP	SPRFRMD?	0: Center/Span Mode	
STSP	SPRFRMD STSP		1: Start/Stop Mode	
Result				
ABS	SPRRES ABS	SPRRES?	0: Absolute	
REL	SPRRES REL		1: Relative	
MKR	SPRRES MKR		2: Marker	

Table 4-12 TRANSIENT Key

Function	Listener Code	Talker Request		Remarks
		Code	Output Format	
Inband Spurious (1)	Ref Power MKR MOD	SPRREF MKR SPRREF MOD	SPRREF?	0: Reference Marker 1: Modulation
	Peak MKR Y-Delta	SPRPKMKY *	SPRPKMKY?	Real Number
	Set to STD	SPRSETSTD	-	-
	Starts measurement			
	Inband Spurious	SPRMEAS	-	-
	Starts measurement in the same mode	SI	-	-
	Measurement results			
	Inband spurious	-	SPRMEAS?	n<CR+LF>+f1,l1,j1<CR+LF> +fn,ln,jn<CR+LF> n:Amount (Integer) fn: Frequency ln: Level (dBm/W/dBμV) jn: Integer (0: FAIL, 1: PASS, -1: Judgement OFF)
	Ref. Power	-	SPRREFPWR?	Level
	Inband Spurious (2)	Auto Level Set	SPR2AUTOLVL	-
Template				
Template ON OFF		SPR2TMPL ON SPR2TMPL OFF	SPR2TMPL?	0: OFF 1: ON
Template Shift				
Shift X Shift Y		SPR2TMPLSX * SPR2TMPLSY *	SPR2TMPLSX? SPR2TMPLSY?	Frequency Level
Margin delta X		SPR2TMPLDX *	SPR2TMPLDX?	Frequency(0:OFF)
Copy from STD		SPR2TMPLCP	-	-
Data Input		SPR2TMPLD **,*	-	f1,l1 f1: Frequency l1: Level (dBm/W/dBμV)
Init Table		SPR2TMPLCLR	-	-
Marker Edit				
Copy from STD	SPR2MKRCP	-	-	

4.2 GPIB Command Codes

Table 4-12 TRANSIENT Key

Function	Listener Code	Talker Request		Remarks	
		Code	Output Format		
Inband Spurious (2)	Data Input	SPR2MKRED *,*,*,*	-	d1, f1,f2,l1 d1: (0: Peak, 1: Integral) f1: Start Frequency f2: Stop Frequency l1: Limit Level	Set the reference bandwidth to f2, after initializing the table.
	Init Table	SPR2MKRCLR	-	-	
	Average Times	SPR2AVGCNT *	SPR2AVGCNT?	Integer (1:OFF, 2 to 999)	
		SPR2AVG *	SPR2AVG?	Integer (1:OFF, 2 to 999)	
	Average Mode POWER AVG	SPR2AVGMD POWER	SPR2AVGMD?	2: Power Avg	
	Parameter Setup				
	Detector				
	Normal	SPR2DET NRM	SPR2DET?	0: Normal	
	Posi	SPR2DET POS		1: Posi	
	Nega	SPR2DET NEG		2: Nega	
	Sample	SPR2DET SMP		3: Sample	
	Display Unit				
	dBm	SPR2UNIT DBM	SPR2UNIT?	0: dBm	
	W	SPR2UNIT W		1: W	
	dBμV	SPR2UNIT DBUV		2: dBμV	
Template Couple to Power					
ON	SPR2TMPLPW ON	SPR2TMPLPW?	0: OFF		
OFF	SPR2TMPLPW OFF		1: ON		
Template Limit	SPR2TMPLBTM *	SPR2TMPLBTM?	Level (dBm/W/dBμV)		
Judgement					
ON	SPR2JDG ON	SPR2JDG?	0: OFF		
OFF	SPR2JDG OFF		1: ON		
Freq. Setting					
CFSP	SPR2FRMD CFSP	SPR2FRMD?	0: Center/Span Mode		
STSP	SPR2FRMD STSP		1: Start/Stop Mode		
Result					
ABS	SPR2RES ABS	SPR2RES?	0: Absolute		
REL	SPR2RES REL		1: Relative		
MKR	SPR2RES MKR		2: Marker		

Table 4-12 TRANSIENT Key

Function		Listener Code	Talker Request		Remarks
			Code	Output Format	
Inband Spurious (2)	Ref Power				
	MKR	SPR2REF MKR	SPR2REF?	0: Reference Marker	
	MOD	SPR2REF MOD		1: Modulation	
	Peak MKR Y-Delta	SPR2PKMKY *	SPR2PKMKY?	Real Number	
	Band Conversion				
	ON	SPR2CONV ON	SPR2CONV?	0: OFF	
	OFF	SPR2CONV OFF		1: ON	
	Integral Band	SPR2INTE *	SPR2INTE?	Frequency	
	Start Offset	SPR2OFSST *	SPR2OFSST?	Frequency	
	Stop Offset	SPR2OFSSP *	SPR2OFSSP?	Frequency	
	Set to STD	SPR2SETSTD	-	-	
	Starts measurement				
	Inband Spurious	SPR2MEAS	-	-	
	Starts measurement in the same mode	SI	-	-	
Measurement results					
Inband spurious	-	SPR2MEAS?	n<CR+LF>+f1,l1,j1<CR+LF> +fn,ln,jn<CR+LF> n:Amount (Integer) fn: Frequency ln: Level (dBm/W/dBμV) jn: Integer (0: FAIL, 1: PASS, -1: Judgement OFF)		
Ref. Power	-	SPR2REFPWR?	Level		

4.2 GPIB Command Codes

Table 4-12 TRANSIENT Key

Function	Listener Code	Talker Request		Remarks		
		Code	Output Format			
Outband Spurious	Auto Level Set	FDSAUTOLVL	-	-		
	Table					
	Copy from STD	FDSCP				
	Table No.1/2/3	FDSTBL *	FDSTBL?	Integer (1 to 3)		
	Table Edit	FDSTBLED *,*,*,*,*,*	-	f1,f2,f3,f4,d1,l1 f1: Start Frequency f2: Stop Frequency f3: RBW f4: VBW d1: Sweep Time l1: Limit Level		
	Load Table	FDSLDD	-	-		
	Save Table	FDSSV	-	-		
	Init Table	FDSCLR	-	-		
	Average Times	FDSAVGCNT *	FDSAVGCNT?	Integer (1:OFF, 2 to 999)		*1
		FDSAVG *	FDSAVG?	Integer (1:OFF, 2 to 999)		
	Average Mode					
	TRACE AVG	FDSAVGMD TRACE	FDSAVGMD?	0: Trace Avg		
	MAX HOLD	FDSAVGMD MAX		1: Max Hold		
POWER AVG	FDSAVGMD POWER		2: Power Avg			
Parameter Setup						
Detector						
Normal	FDSDET NRM	FDSDET?	0: Normal			
Posi	FDSDET POS		1: Posi			
Nega	FDSDET NEG		2: Nega			
Sample	FDSDET SMP		3: Sample			
Display Unit						
dBm	FDSUNIT DBM	FDSUNIT?	0: dBm			
W	FDSUNIT W		1: W			
dBμV	FDSUNIT DBUV		2: dBμV			

*1: When Detector is set to Positive, Average Mode is set to MAX HOLD. When Detector is set to something other than Positive, Average Mode is set to TRACE AVG.

Table 4-12 TRANSIENT Key

Function		Listener Code	Talker Request		Remarks
			Code	Output Format	
Outband Spurious	Judgement ON OFF	FDSJDG ON FDSJDG OFF	FDSJDG?	0: OFF 1: ON	
	Peak MKR Y-Delta	FDSPKMKY *	FDSPKMKY?	Real Number	
	Preselector 1.6G 3.6G	FDSPRE 16G FDSPRE 36G	FDSPRE?	0:1.6G 1:3.6G	
	Set to Default	FDSSETSTD	-	-	
	Starts measurement Outband Spurious	FDSMEAS	-	-	
	Starts measurement in the same mode	SI	-	-	
	Measurement results Outband Spurious	-	FDSMEAS?	n<CR+LF>+f1,l1,j1< CR+LF> +fn,ln,jn<CR+LF> n: Amount (Integer) fn: Frequency ln: Level (dBm/W/dBμV) jn: Integer (0: FAIL, 1: PASS, -1: Judgement OFF)	

4.2 GPIB Command Codes

Table 4-12 TRANSIENT Key

Function	Listener Code	Talker Request		Remarks	
		Code	Output Format		
3GPP	Auto Level Set	AUTOLVL	-	-	
	Display Type				
	Format				
	NUMERIC	3GPFMT NUM	3GPFMT?	0: GRAPH	
	GRAPH	3GPFMT GRP		1: TABLE	
	TABLE	3GPFMT TBL		2: NUMERIC	
	Display				
	SINGLE	3GPDISP SNGL	3GPDISP?	0: SINGLE	
	DUAL	3GPDISP DUAL		1: DUAL	
	Y Scale				
	ρ	3GPYSCL RHO	3GPYSCL?	0: ρ	
	POWER (dB)	3GPYSCL POW		1: POWER (dB)	
	POWER (dBm)	3GPYSCL POWABS		2: POWER (dBm)	
	EVM	3GPYSCL EVM		3: EVM	
	X Scale				
	CODE	3GPXSCL CODE	3GPXSCL?	0: CODE	
	TIME	3GPXSCL TIME		1: TIME	
	View Point				
	Code/Time	3GPVWPT *	3GPVWPT?	Integer	
	Page	3GPPAGE *	3GPPAGE?	Integer	
	Graphics				
	Display Start	3GPDSPST *	3GPDSPST?	Integer	
	Select Type				
	Constellation	3GPGTYP CON	3GPGTYP?	0: Constellation	
	Constellation(Line)	3GPGTYP CONLIN		1: Constellation (Line)	
	Constellation(Dot)	3GPGTYP CONDOT		2: Constellation (Dot)	
	Constellation (Line&Chip) (Line&Symbol)	3GPGTYP CONLINDOT		3: Constellation (Line&Chip) (Line&Symbol)	
	I EYE Diagram	3GPGTYP ICHEYE		4: I EYE Diagram	
	Q EYE Diagram	3GPGTYP QCHEYE		5: Q EYE Diagram	
	I/Q EYE Diagram	3GPGTYP IQCHEYE		6: I/Q EYE Diagram	
	E.V.M. vs Chip/Symbol	3GPGTYP EVM		7: E.V.M. vs Chip/ Symbol	
	Mag Error vs Chip/ Symbol	3GPGTYP MAGERR		8: Mag Error vs Chip/ Symbol	
	Phase Error vs Chip/Symbol	3GPGTYP PHAERR		9: Phase Error vs Chip/ Symbol	
	SCH Power	3GPGTYP SCHPWR		10: SCH Power	

Table 4-12 TRANSIENT Key

Function	Listener Code	Talker Request		Remarks
		Code	Output Format	
3GPP	45deg Turn ON	3GPTURN ON	3GPTURN?	0: OFF
	OFF	3GPTURN OFF		1: ON
	Demod Data Save	3GPDEMOSV	-	
	Parameter Setup (When set to DOWN- LINK and One Slot.)			
	Meas Mode			
	PRECISE	3GPDNMEASMD PREC	3GPDNMEASMD?	0: PRECISE
	CONCISE	3GPDNMEASMD CONC		1: CONCISE
	Peak CDE			
	ON	3GPDNPKCDE ON	3GPDNPKCDE?	0: OFF
	OFF	3GPDNPKCDE OFF		1: ON
	Scrambling Code Define			
	DEFINE	3GPSCDEF DEF	3GPSCDEF?	0: DEFINE
	UNDEFINE	3GPSCDEF UNDEF		1: UNDEFINE
	Scrambling Code No.	3GPDNSCNO * 3GPDNSCNOHEX *	3GPDNSCNO? 3GPDNSCNOHEX?	Integer (0 to 262142) Hexadecimal number (0 to 3FFFE)
	Trigger Mode			
INT	3GPDNTRG INT	3GPDNTRG?	0: INT	
EXT	3GPDNTRG EXT		1: EXT	
EXT (SFN)	3GPDNTRG SFN		2:EXT(SFN)	
EXT Trigger Slope				
+	3GPDNTRGSLP RISE	3GPDNTRGSLP?	0: -	
-	3GPDNTRGSLP FALL		1: +	
EXT Trigger Delay	3GPDNTRGDLY *	3GPDNTRGDLY?	Real number (-5120.00 to 38400.00)	
Search Mode				
SCH	3GPSRCH SCH	3GPSRCH?	0: SCH	
Primary CPICH	3GPSRCH PCPICH		1: Primary CPICH	
SCH (LONG)	3GPSRCH SCHLONG		2:SCH(LONG)	

4.2 GPIB Command Codes

Table 4-12 TRANSIENT Key

Function	Listener Code	Talker Request		Remarks
		Code	Output Format	
3GPP	Primary CPICH SF	3GPCPICHSF *	3GPCPICHSF?	Integer (4/8/16/32/64/128/256/512)
	Primary CPICH No.	3GPCPICHNO *	3GPCPICHNO?	Integer (0 to 511)
	Active CH. Detection			
	AUTO	3GPACTCH AUTO	3GPACTCH?	0: AUTO
	USER TABLE	3GPACTCH USER		1: USER TABLE
	Test Model 1 DPCH 16 Code	3GPACTCH T1DP16		2: Test Model 1 DPCH 16Code
	Test Model 1 DPCH 32 Code	3GPACTCH T1DP32		3: Test Model 1 DPCH 32Code
	Test Model 1 DPCH 64 Code	3GPACTCH T1DP64		4: Test Model 1 DPCH 64Code
	Test Model 2	3GPACTCH T2		5: Test Model 2
	Test Model 3 DPCH 16 Code	3GPACTCH T3DP16		6: Test Model 3 DPCH 16Code
	Test Model 3 DPCH 32 Code	3GPACTCH T3DP32		7: Test Model 3 DPCH 32Code
	Analysis Rate			
	ACTIVE	3GPDNRATE ACT	3GPDNRATE?	0: ACTIVE
	7.5ksps	3GPDNRATE 7K5		1: 7.5ksps
	15ksps	3GPDNRATE 15K		2: 15ksps
	30ksps	3GPDNRATE 30K		3: 30ksps
	60ksps	3GPDNRATE 60K		4: 60ksps
	120ksps	3GPDNRATE 120K		5: 120ksps
	240ksps	3GPDNRATE 240K		6: 240ksps
	480ksps	3GPDNRATE 480K		7: 480ksps
	960ksps	3GPDNRATE 960K		8: 960ksps
	ACT+N	3GPDNRATE ACTN		9: ACT+N
	Meas Unit	3GPDNMUNIT *	3GPDNMUNIT?	Integer (1 to 640)
	Meas Start Position	3GPDNMSTSLT *	3GPDNMSTSLT?	Integer (0 to 140)
	Threshold	3GPDNTHRSH *	3GPDNTHRSH?	Integer (-40 to -5dB)
	Phase Inverse			
	NORMAL	3GPDNPHASE NORM	3GPDNPHASE?	0: NORMAL
	INVERSE	3GPDNPHASE INV		1: INVERSE
	Frequency Error			
	NORMAL	3GPDNFERR NORM	3GPDNFERR?	0: NORMAL
	PRECISE	3GPDNFERR PREC		1: PRECISE
	Transmit Timing			
	ON	3GPTRNSTM ON	3GPTRNSTM?	0: OFF
	OFF	3GPTRNSTM OFF		1: ON

Table 4-12 TRANSIENT Key

Function	Listener Code	Talker Request		Remarks	
		Code	Output Format		
3GPP	(When set to DOWN-LINK and FRAME) Scrambling Code Define DEFINE UNDEFINE	3GPSCDEF DEF 3GPSCDEF UNDEF	3GPSCDEF?	0: DEFINE 1: UNDEFINE	
	Scrambling Code No.	3GPDNSCNO * 3GPDNSCNOHEX *	3GPDNSCNO? 3GPDNSCNOHEX?	Integer (0 to 262142) Hexadecimal number (0 to 3FFFE)	
	Trigger Mode INT EXT EXT (SFN)	3GPDNTRG INT 3GPDNTRG EXT 3GPDNTRG SFN	3GPDNTRG?	0: INT 1: EXT 2: EXT (SFN)	
	EXT Trigger Slope + -	3GPDNTRGSLP RISE 3GPDNTRGSLP FALL	3GPDNTRGSLP?	0: - 1: +	
	EXT Trigger Delay	3GPDNTRGDLY *	3GPDNTRGDLY?	Real number (-5120.00 to 38400.00)	
	Search Mode SCH Primary CPICH SCH (LONG)	3GPSRCH SCH 3GPSRCH PCPICH 3GPSRCH SCHLONG	3GPSRCH?	0: SCH 1: Primary CPICH 2: SCH (LONG)	
	Primary CPICH SF	3GPCPICHSF *	3GPCPICHSF?	Integer (4/8/16/32/64/128/256/512)	
	Primary CPICH No.	3GPCPICHNO *	3GPCPICHNO?	Integer (0 to 511)	
	Active CH. Detection AUTO USER TABLE Test Model 1 DPCH 16Code Test Model 1 DPCH 32Code Test Model 1 DPCH 64Code Test Model 2 Test Model 3 DPCH 16Code Test Model 3 DPCH 32Code	3GPACTCH AUTO 3GPACTCH USER 3GPACTCH T1DP16 3GPACTCH T1DP32 3GPACTCH T1DP64 3GPACTCH T2 3GPACTCH T3DP16 3GPACTCH T3DP32	3GPACTCH?	0: AUTO 1: USER TABLE 2: Test Model 1 DPCH 16Code 3: Test Model 1 DPCH 32Code 4: Test Model 1 DPCH 64Code 5: Test Model 2 6: Test Model 3 DPCH 16Code 7: Test Model 3 DPCH 32Code	

4.2 GPIB Command Codes

Table 4-12 TRANSIENT Key

Function	Listener Code	Talker Request		Remarks
		Code	Output Format	
3GPP	Meas Channel SF	3GPDNMCHSF *	3GPDNMCHSF?	Integer (4/8/16/32/64/128/256/512)
	Meas Channel No.	3GPDNMCHNO *	3GPDNMCHNO?	Integer (0 to 511)
	Meas Slots	3GPDNMSLOT *	3GPDNMSLOT?	Integer (1 to 30)
	Meas Start Position	3GPDNMSTFRM *	3GPDNMSTFRM?	Integer (0 to 639)
	Threshold	3GPDNTHRSH *	3GPDNTHRSH?	Integer (-40 to -5dB)
	Phase Inverse NORMAL INVERSE	3GPDNPHASE NORM 3GPDNPHASE INV	3GPDNPHASE?	0: NORMAL 1: INVERSE
	(When set to UPLINK and One Slot) Meas Mode PRECISE CONCISE Scrambling Code No.	3GPUPMEASMD PREC 3GPUPMEASMD CONC 3GPUPSCNO * 3GPUPSCNOHEX *	3GPUPMEASMD? 3GPUPSCNO? 3GPUPSCNOHEX?	0: PRECISE 1: CONCISE Integer (0 to 16777215) Hexadecimal number (0 to FFFFFFFF)
	Trigger Mode INT EXT	3GPUPTRG INT 3GPUPTRG EXT	3GPUPTRG?	0: INT 1: EXT
	EXT Trigger Slope + -	3GPUPTRGSLP RISE 3GPUPTRGSLP FALL	3GPUPTRGSLP?	0: - 1: +
	EXT Trigger Delay	3GPUPTRGDLY *	3GPUPTRGDLY?	Real number (-5120.00 to 38400.00)
	DPCCH SF	3GPDPCCHSF *	3GPDPCCHSF?	Integer (4/8/16/32/64/128/256)
	DPCCH No.	3GPDPCCHNO *	3GPDPCCHNO?	Integer (0 to 255)

Table 4-12 TRANSIENT Key

Function	Listener Code	Talker Request		Remarks
		Code	Output Format	
3GPP	Analysis Rate			
	15ksps	3GPUPRATE 15K	3GPUPRATE?	2: 15ksps
	30ksps	3GPUPRATE 30K		3: 30ksps
	60ksps	3GPUPRATE 60K		4: 60ksps
	120ksps	3GPUPRATE 120K		5: 120ksps
	240ksps	3GPUPRATE 240K		6: 240ksps
	480ksps	3GPUPRATE 480K		7: 480ksps
	960ksps	3GPUPRATE 960K		8: 960ksps
	Meas Unit	3GPUPMUNIT *	3GPUPMUNIT?	Integer (1 to 640)
	Meas Start Position	3GPUPMSTSLT *	3GPUPMSTSLT?	Integer (0 to 140)
	Threshold	3GPUPTHRSH *	3GPUPTHRSH?	Integer (-40 to -5dB)
	Phase Inverse			
	NORMAL	3GPUPPHASE NORM	3GPUPPHASE?	0: NORMAL
	INVERSE	3GPUPPHASE INV		1: INVERSE
	Frequency Error			
	NORMAL	3GPUPFERR NORM	3GPUPFERR?	0: NORMAL
	PRECISE	3GPUPFERR PREC		1: PRECISE
	(When set to UPLINK and FRAME) Scrambling Code No.	3GPUPSCNO * 3GPUPSCNOHEX *	3GPUPSCNO? 3GPUPSCNOHEX?	Integer (0 to 16777215) Hexadecimal number (0 to FFFFFFFF)
Trigger Mode				
INT	3GPUPTRG INT	3GPUPTRG?	0: INT	
EXT	3GPUPTRG EXT		1: EXT	
EXT Trigger Slope				
+	3GPUPTRGSLP RISE	3GPUPTRGSLP?	0: -	
-	3GPUPTRGSLP FALL		1: +	
EXT Trigger Delay	3GPUPTRGDLY *	3GPUPTRGDLY?	Real number (-5120.00 to 38400.00)	
DPCCH SF	3GPDPCCHSF *	3GPDPCCHSF?	Integer (4/8/16/32/64/128/256)	
DPCCH No.	3GPDPCCHNO *	3GPDPCCHNO?	Integer (0 to 255)	
Meas Channel SF	3GPUPMCHSF *	3GPUPMCHSF?	Integer (4/8/16/32/64/128/256)	
Meas Channel No.	3GPUPMCHNO *	3GPUPMCHNO?	Integer (0 to 255)	

4.2 GPIB Command Codes

Table 4-12 TRANSIENT Key

Function	Listener Code	Talker Request		Remarks
		Code	Output Format	
3GPP	Meas Branch			
	I	3GPMBRCH I	3GPMBRCH?	0: I
	Q	3GPMBRCH Q		1: Q
	Meas Slots	3GPUPMSLOT *	3GPUPMSLOT?	Integer (1 to 30)
	Meas Start Position	3GPUPMSTFRM *	3GPUPMSTFRM?	Integer (0 to 639)
	Threshold	3GUPTHRSH *	3GUPTHRSH?	Integer (-40 to -5dB)
	Phase Inverse			
	NORMAL	3GUPPHASE NORM	3GUPPHASE?	0: NORMAL
	INVERSE	3GUPPHASE INV		1: INVERSE
	Table Edit			
	Multi Channel No.	3GPMLTNUM *	3GPMLTNUM?	Integer (1 to 32)
	Ch1 SF	3GPCH1SF *	3GPCH1SF?	Integer (4/8/16/32/64/128/256/512)
	Ch1 Number	3GPCH1NUM *	3GPCH1NUM?	Integer (0 to 511)
	Ch2 SF	3GPCH2SF *	3GPCH2SF?	Integer (4/8/16/32/64/128/256/512)
	Ch2 Number	3GPCH2NUM *	3GPCH2NUM?	Integer (0 to 511)
	Ch3 SF	3GPCH3SF *	3GPCH3SF?	Integer (4/8/16/32/64/128/256/512)
	Ch3 Number	3GPCH3NUM *	3GPCH3NUM?	Integer (0 to 511)
	Ch4 SF	3GPCH4SF *	3GPCH4SF?	Integer (4/8/16/32/64/128/256/512)
	Ch4 Number	3GPCH4NUM *	3GPCH4NUM?	Integer (0 to 511)
	Ch5 SF	3GPCH5SF *	3GPCH5SF?	Integer (4/8/16/32/64/128/256/512)
Ch5 Number	3GPCH5NUM *	3GPCH5NUM?	Integer (0 to 511)	
Ch6 SF	3GPCH6SF *	3GPCH6SF?	Integer (4/8/16/32/64/128/256/512)	
Ch6 Number	3GPCH6NUM *	3GPCH6NUM?	Integer (0 to 511)	

Table 4-12 TRANSIENT Key

Function	Listener Code	Talker Request		Remarks
		Code	Output Format	
3GPP	Ch7 SF	3GPCH7SF *	3GPCH7SF?	Integer (4/8/16/32/64/128/256/512)
	Ch7 Number	3GPCH7NUM *	3GPCH7NUM?	Integer (0 to 511)
	Ch8 SF	3GPCH8SF *	3GPCH8SF?	Integer (4/8/16/32/64/128/256/512)
	Ch8 Number	3GPCH8NUM *	3GPCH8NUM?	Integer (0 to 511)
	Ch9 SF	3GPCH9SF *	3GPCH9SF?	Integer (4/8/16/32/64/128/256/512)
	Ch9 Number	3GPCH9NUM *	3GPCH9NUM?	Integer (0 to 511)
	Ch10 SF	3GPCH10SF *	3GPCH10SF?	Integer (4/8/16/32/64/128/256/512)
	Ch10 Number	3GPCH10NUM *	3GPCH10NUM?	Integer (0 to 511)
	Ch11 SF	3GPCH11SF *	3GPCH11SF?	Integer (4/8/16/32/64/128/256/512)
	Ch11 Number	3GPCH11NUM *	3GPCH11NUM?	Integer (0 to 511)
	Ch12 SF	3GPCH12SF *	3GPCH12SF?	Integer (4/8/16/32/64/128/256/512)
	Ch12 Number	3GPCH12NUM *	3GPCH12NUM?	Integer (0 to 511)
	Ch13 SF	3GPCH13SF *	3GPCH13SF?	Integer (4/8/16/32/64/128/256/512)
	Ch13 Number	3GPCH13NUM *	3GPCH13NUM?	Integer (0 to 511)
	Ch14 SF	3GPCH14SF *	3GPCH14SF?	Integer (4/8/16/32/64/128/256/512)
	Ch14 Number	3GPCH14NUM *	3GPCH14NUM?	Integer (0 to 511)
	Ch15 SF	3GPCH15SF *	3GPCH15SF?	Integer (4/8/16/32/64/128/256/512)
	Ch15 Number	3GPCH15NUM *	3GPCH15NUM?	Integer (0 to 511)
	Ch16 SF	3GPCH16SF *	3GPCH16SF?	Integer (4/8/16/32/64/128/256/512)
	Ch16 Number	3GPCH16NUM *	3GPCH16NUM?	Integer (0 to 511)
Ch17 SF	3GPCH17SF *	3GPCH17SF?	Integer (4/8/16/32/64/128/256/512)	
Ch17 Number	3GPCH17NUM *	3GPCH17NUM?	Integer (0 to 511)	
Ch18 SF	3GPCH18SF *	3GPCH18SF?	Integer (4/8/16/32/64/128/256/512)	
Ch18 Number	3GPCH18NUM *	3GPCH18NUM?	Integer (0 to 511)	

4.2 GPIB Command Codes

Table 4-12 TRANSIENT Key

Function	Listener Code	Talker Request		Remarks
		Code	Output Format	
3GPP	Ch19 SF	3GPCH19SF *	3GPCH19SF?	Integer (4/8/16/32/64/128/256/512)
	Ch19 Number	3GPCH19NUM *	3GPCH19NUM?	Integer (0 to 511)
	Ch20 SF	3GPCH20SF *	3GPCH20SF?	Integer (4/8/16/32/64/128/256/512)
	Ch20 Number	3GPCH20NUM *	3GPCH20NUM?	Integer (0 to 511)
	Ch21 SF	3GPCH21SF *	3GPCH21SF?	Integer (4/8/16/32/64/128/256/512)
	Ch21 Number	3GPCH21NUM *	3GPCH21NUM?	Integer (0 to 511)
	Ch22 SF	3GPCH22SF *	3GPCH22SF?	Integer (4/8/16/32/64/128/256/512)
	Ch22 Number	3GPCH22NUM *	3GPCH22NUM?	Integer (0 to 511)
	Ch23 SF	3GPCH23SF *	3GPCH23SF?	Integer (4/8/16/32/64/128/256/512)
	Ch23 Number	3GPCH23NUM *	3GPCH23NUM?	Integer (0 to 511)
	Ch24 SF	3GPCH24SF *	3GPCH24SF?	Integer (4/8/16/32/64/128/256/512)
	Ch24 Number	3GPCH24NUM *	3GPCH24NUM?	Integer (0 to 511)
	Ch25 SF	3GPCH25SF *	3GPCH25SF?	Integer (4/8/16/32/64/128/256/512)
	Ch25 Number	3GPCH25NUM *	3GPCH25NUM?	Integer (0 to 511)
	Ch26 SF	3GPCH26SF *	3GPCH26SF?	Integer (4/8/16/32/64/128/256/512)
	Ch26 Number	3GPCH26NUM *	3GPCH26NUM?	Integer (0 to 511)
	Ch27 SF	3GPCH27SF *	3GPCH27SF?	Integer (4/8/16/32/64/128/256/512)
	Ch27 Number	3GPCH27NUM *	3GPCH27NUM?	Integer (0 to 511)
	Ch28 SF	3GPCH28SF *	3GPCH28SF?	Integer (4/8/16/32/64/128/256/512)
	Ch28 Number	3GPCH28NUM *	3GPCH28NUM?	Integer (0 to 511)
	Ch29 SF	3GPCH29SF *	3GPCH29SF?	Integer (4/8/16/32/64/128/256/512)
	Ch29 Number	3GPCH29NUM *	3GPCH29NUM?	Integer (0 to 511)
	Ch30 SF	3GPCH30SF *	3GPCH30SF?	Integer (4/8/16/32/64/128/256/512)
	Ch30 Number	3GPCH30NUM *	3GPCH30NUM?	Integer (0 to 511)
	Ch31 SF	3GPCH31SF *	3GPCH31SF?	Integer (4/8/16/32/64/128/256/512)
	Ch31 Number	3GPCH31NUM *	3GPCH31NUM?	Integer (0 to 511)
	Average Times	3GPAVG *	3GPAVG?	Integer (1: OFF, 2 to 32)

Table 4-12 TRANSIENT Key

Function	Listener Code	Talker Request		Remarks	
		Code	Output Format		
3GPP	Starts measurement 3GPP	3GPP	-	-	
	Starts measurement in the same mode	SI	-	-	
	Measurement results (When measuring DOWN- LINK and One Slot)				
	ρ	-	3GPRHO?	Real number	
	τ (Time)	-	3GPTAU?	Time (sec)	
	τ (Chip)	-	3GPTAUCHIP?	Real number (chip)	
	Carrier Frequency Error (Hz)	-	3GPCFER?	Frequency(Hz)	
	Carrier Frequency Error (ppm)	-	3GPCFERPPM?	ppm	
	I/Q Origin Offset	-	3GPIQOFS?	Level (dBc)	
	Magnitude Error	-	3GPMAG?	% rms	
	Phase Error	-	3GPPHSE?	deg. rms	
	Error Vector Magnitude	-	3GPMOD?	% rms	
	Peak Magnitude Error	-	3GPPKMAG?	%	
	Peak Phase Error	-	3GPPKPHSE?	deg.	
	Peak Error Vector Magnitude	-	3GPPKMOD?	%	
	Slot	-	3GPSLOT?	Integer	
	Scrambling Code No.	-	3GPSCCD?	Integer	
	Scrambling Code Group No.	-	3GPSCGRP?	Integer	
	SCH Power	-	3GPSCHPWR?	Level (dB)	
	Power Ratio P-SCH:S-SCH	-	3GPPRATIO?	Level (dB)	
Peak Code Domain Error	-	3GPPKCDE?	Level (dB)		

4.2 GPIB Command Codes

Table 4-12 TRANSIENT Key

Function	Listener Code	Talker Request		Remarks
		Code	Output Format	
3GPP Code Domain Power Marker Marker Position	3GPMK *	-	Integer (Code/Time)	The marker position can be specified from the left (0, 1, 2 and so on) when Analysis Rate is set to ACTIVE.
Code No.	-	3GPMKCODE?	Integer	
Time	-	3GPMKTIME?	Integer	
Code Power (dB)	-	3GPMKPOW?	Level (dB)	
Code Power (dBm)	-	3GPMKPOWABS?	Level (dBm)	
ρ	-	3GPMKRHO?	Real number	
E.V.M.	-	3GPMKEVM?	% rms	
Toffset	-	3GPMKTING?	Integer (chip)	Parameters can be read only when Transmit Timing is ON.
Toffset x256 chip	-	3GPMKTX256?	Integer (x256 chip)	
τ	-	3GPMKTAU?	Time (sec)	
Phase	-	3GPMKPHSE?	Real number (deg.)	
(When DOWNLINK and FRAME)				
τ (Time)	-	3GPTAU?	Time (sec)	
τ (Chip)	-	3GPTAUCHIP?	Real number (chip)	
Carrier Frequency Error (Hz)	-	3GPCFER?	Frequency(Hz)	
Carrier Frequency Error (ppm)	-	3GPCFERPPM?	ppm	
I/Q Origin Offset	-	3GPIQOFS?	Level (dBc)	
Magnitude Error	-	3GPMAG?	% rms	
Phase Error	-	3GPPHSE?	deg. rms	
Error Vector Magnitude	-	3GPMOD?	% rms	
Peak Magnitude Error	-	3GPPKMAG?	%	
Peak Phase Error	-	3GPPKPHSE?	deg.	
Peak Error Vector Magnitude	-	3GPPKMOD?	%	
Slot	-	3GPSLOT?	Integer	
Scrambling Code No.	-	3GPSCCD?	Integer	
Scrambling Code Group No.	-	3GPSCGRP?	Integer	
Power Ratio P-SCH:S-SCH	-	3GPPRATIO?	Level (dB)	
Average Ch. Power	-	3GPAVGCHPWR?	Level (dBm)	

Table 4-12 TRANSIENT Key

Function	Listener Code	Talker Request		Remarks	
		Code	Output Format		
3GPP	Code Domain Power Marker	3GPMK *	-	Integer (Slot position)	
	Marker Position				
	Slot No.	-	3GPMKCODE?	Integer	
	Code Power (dB)	-	3GPMKPOW?	Level (dB)	
	Code Power (dBm)	-	3GPMKPOWABS?	Level (dBm)	
	ρ	-	3GPMKRHO?	Real number	
	E.V.M.	-	3GPMKEVM?	Real number (% rms)	
	Demod Data output	3GPDEMOMD	3GPDEMOMD?	1/0 Character	*1
	(When UPLINK and One Slot)				
	ρ	-	3GPRHO?		
	τ (Time)	-	3GPTAU?	Time (sec)	
	τ (Chip)	-	3GPTAUCHIP?	Real number (chip)	
	Carrier Frequency Error (Hz)	-	3GPCFER?	Frequency(Hz)	
	Carrier Frequency Error (ppm)	-	3GPCFERPPM?	ppm	
	I/Q Origin Offset	-	3GPIQOFS?	Level (dBc)	
	Magnitude Error	-	3GPMAG?	% rms	
	Phase Error	-	3GPPHSE?	deg. rms	
	Error Vector Magnitude	-	3GPMOD?	% rms	
	Peak Magnitude Error	-	3GPPKMAG?	%	
	Peak Phase Error	-	3GPPKPHSE?	deg.	
Peak Error Vector Magnitude	-	3GPPKMOD?	%		

*1: After the measurement, the Demodulated data is generated by using the 3G DEMOD command and then it can be read by using the 3GPDEMOMD? command.

4.2 GPIB Command Codes

Table 4-12 TRANSIENT Key

Function	Listener Code	Talker Request		Remarks
		Code	Output Format	
3GPP	Slot	-	3GPSLOT?	Integer
	Peak Code Domain Error	-	3GPPKCDE?	Level (dB)
	Code Domain Power Marker			
	Marker Position	3GPMK *	-	Integer (Code/Time)
	Code No.	-	3GPMKCODE?	Integer
	Time	-	3GPMKTIME?	Integer
	I Phase Code Power (dB)	-	3GPMKPOW?	Level (dB)
	I Phase Code Power (dBm)	-	3GPMKPOWABS?	Level (dBm)
	I Phase ρ	-	3GPMKRHO?	Real number
	I Phase E.V.M.	-	3GPMKEVM?	% rms
	I Phase Timing	-	3GPMKTING?	Integer (chip)
	Q Phase Code Power (dB)	-	3GPMKPOWQ?	Level (dB)
	Q Phase Code Power (dBm)	-	3GPMKPOWABS?	Level (dBm)
	Q Phase ρ	-	3GPMKRHOQ?	Real number
	Q Phase E.V.M.	-	3GPMKEVMQ?	% rms
	Q Phase Timing	-	3GPMKTINGQ?	Integer (chip)
	(When UPLINK and FRAME)			
	τ (Time)	-	3GPTAU?	Time (sec)
	τ (Chip)	-	3GPTAUCHIP?	Real number (chip)
	Carrier Frequency Error (Hz)	-	3GPCFER?	Frequency(Hz)
	Carrier Frequency Error (ppm)	-	3GPCFERPPM?	ppm
	I/Q Origin Offset	-	3GPIQOFS?	Level (dBc)
	Error Vector Magnitude	-	3GPMOD?	% rms
	Peak Error Vector Magnitude	-	3GPPKMOD?	%
	Slot	-	3GPSLOT?	Integer
	Average Ch. Power		3GPAVGCHPWR?	Level (dBm)
	Code Domain Power Marker			
	Marker Position	3GPMK *	-	Integer (Slot position)
	Slot No.	-	3GPMKCODE?	Integer
	Code Power (dB)	-	3GPMKPOW?	Level (dB)
	Code Power (dBm)	-	3GPMKPOWABS?	Level (dBm)
	ρ	-	3GPMKRHO?	Real number
	E.V.M.	-	3GPMKEVM?	Real number (% rms)

Table 4-12 TRANSIENT Key

Function	Listener Code	Talker Request		Remarks	
		Code	Output Format		
3GPP	Demod Data output	3GPDEMOM	3GPDEMOM?	1/0 Character	*1
	Graphics Marker				
	Constellation				
	Constellation(Line)				
	Constellation(Dot)				
	Constellation (Line&Chip) (Line&Symbol)				
	I EYE Diagram				
	Q EYE Diagram				
	I/Q EYE Diagram				
	Chip/Symbol number	3GPMKCHIP *	3GPMKCHIP?	Integer	
	I data	-	3GPMKI?	Phase	
	Q data	-	3GPMKQ?	Phase	
	E.V.M. vs Chip/Symbol				
	Mag Error vs Chip/Symbol				
	Chip/Symbol number	3GPMKCHIP *	3GPMKCHIP?	Integer	
	Marker Y data	-	3GPMKERR?	%	
	Phase Error vs Chip/Symbol				
	Chip/Symbol number	3GPMKCHIP *	3GPMKCHIP?	Integer	
	Marker Y data	-	3GPMKDEG?	degree	
	SCH Power				
	Slot Position	3GPMKSCH *	3GPMKSCH?	Integer (Slot No.)	
	SCH Power (dB)	-	3GPMKSCHPOW?	Level (dB)	
	SCH Power (dBm)	-	3GPMKSCHPOWABS?	Level (dBm)	

*1: After the measurement, the Demodulated data is generated by using the 3G DEMOD command and then it can be read by using the 3GPDEMOM? command.

4.2 GPIB Command Codes

Table 4-12 TRANSIENT Key

Function	Listener Code	Talker Request		Remarks
		Code	Output Format	
Graphics Data output Constellation Constellation (Line)	I-Phase Data	-	GPHI?	n<CR+LF>+d1<CR+LF>+.....+dn<CR+LF> n: Number of output data items (integer) dn: I-phase data (real number)
Constellation (Dot) Constellation (Line&Chip) (Line&Symbol)	Q-Phase Data	-	GPHQ?	n<CR+LF>+d1<CR+LF>+.....+dn<CR+LF> n: Number of output data items (integer) dn: Q-phase data (real number)
I EYE Diagram Q EYE Diagram I/Q EYE Diagram				
I EYE Diagram Q EYE Diagram I/Q EYE Diagram	X-axis data (Chip/Symbol)	-	GPHCHIP? GPHX?	n<CR+LF>+d1<CR+LF>+.....+dn<CR+LF> n: Number of output data items (integer) dn: Chip/Symbol data (integer)
E.V.M. vs Chip/Symbol Mag Error vs Chip/Symbol	X-axis data (Chip/Symbol)	-	GPHCHIP? GPHX?	n<CR+LF>+d1<CR+LF>+.....+dn<CR+LF> n: Number of output data items (integer) dn: Chip/Symbol data (integer)
Phase Error vs Chip/Symbol	Y-axis data	-	GPHY?	n<CR+LF>+d1<CR+LF>+.....+dn<CR+LF> n: Number of output data items (integer) dn: Data (real number)
QPSK	Auto Level Set	AUTOLVL	-	-
	Graphics Display Start	QPDSPST *	QPDSPST?	Integer

Table 4-12 TRANSIENT Key

Function	Listener Code	Talker Request		Remarks
		Code	Output Format	
QPSK	Select Type			
	Constellation	QPGTYP CON	QPGTYP?	0:Constellation
	Constellation(Line)	QPGTYP CONLIN		1:Constellation (Line)
	Constellation(Dot)	QPGTYP CONDOT		2:Constellation (Dot)
	Constellation (Line & Chip)	QPGTYP CONLINCHP		3:Constellation (Line & Chip)
	I EYE Diagram	QPGTYP ICHEYE		4:I EYE Diagram
	Q EYE Diagram	QPGTYP QCHEYE		5:Q EYE Diagram
	I/Q EYE Diagram	QPGTYP IQCHEYE		6:I/Q EYE Diagram
	E.V.M. vs Chip	QPGTYP EVM		7:E.V.M. vs Chip
	Mag Error vs Chip	QPGTYP MAGERR		8:Mag Error vs Chip
	Phase Error vs Chip	QPGTYP PHAERR		9:Phase Error vs Chip
	Parameter Setup			
	Root Nyquist			
	ON	QPRNYQ ON	QPRNYQ?	0:OFF
	OFF	QPRNYQ OFF		1:ON
Meas Range	QPMRNG *	QPMRNG?	Integer	
Trigger Mode				
INT	QPTRG INT	QPTRG?	0:INT	
EXT	QPTRG EXT		1:EXT	
IF	QPTRG IF		2:IF	
EXT Trigger Slope				
+	QPTRGSLP RISE	QPTRGSLP?	0:-	
-	QPTRGSLP FALL		1:+	
Trigger Level	QPTRGLVL *	QPTRGLVL?	Integer (0 to 100%)	
EXT Trigger Delay	QPTRGDLY *	QPTRGDLY?	Real number (-512.000 to 512.000)	
Average Times	QPAVG *	QPAVG?	Integer (1:OFF, 2 to 32)	
Limit Setup				
Judgment				
ON	QPLMJDG ON	QPLMJDG?	0:OFF	
OFF	QPLMJDG OFF		1:ON	
Limit(ρ)	QPLMRHO *	QPLMRHO?	Real number (0.0001 to 1.0000)	

4.2 GPIB Command Codes

Table 4-12 TRANSIENT Key

Function	Listener Code	Talker Request		Remarks
		Code	Output Format	
QPSK	Starting Measurement			
	QPSK	QPSK	-	-
	Starting the Measurement on the same mode	SI	-	-
	Results			
	Total Result			
	ρ	-	QPRHO?	ρ
	Carrier Frequency Error	-	QPFER?	Frequency (Hz)
	Carrier Feedthrough	-	QPIQOFS?	Level (dBc)
	Magnitude Error	-	QPMAG?	% rms
	Phase Error	-	QPPHSE?	degree rms
	Error Vector Magnitude	-	QPMOD?	% rms
	Judgment result	-	QPJDG?	0: FAIL 1: PASS
	Readout the results of graphics			
	Constellation(Line)			
	Constellation(Dot)			
	Constellation (Line & Chip)			
	I EYE Diagram			
	Q EYE Diagram			
	I/Q EYE Diagram			
	Chip No.	QPMKCHIP *	QPMKCHIP?	DispStart to +255
	I data	-	QPMKI?	Phase
	Q data	-	QPMKQ?	Phase
	E.V.M. vs Chip			
Mag Error vs Chip				
Chip No.	QPMKCHIP *	QPMKCHIP?	DispStart to +255	
Marker Y data	-	QPMKERR?	%	
Phase Error vs Chip				
Chip No.	QPMKCHIP *	QPMKCHIP?	DispStart to +255	
Marker Y data	-	QPMKDEG?	degree	

Table 4-12 TRANSIENT Key

Function	Listener Code	Talker Request		Remarks
		Code	Output Format	
Graphics Data output Constellation Constellation (Line)	I-Phase Data	-	GPHI?	n<CR+LF>+d1<CR+LF>+.....+dn<CR+LF> n: Number of output data items (integer) dn: I-phase data (real number)
Constellation (Dot) Constellation (Line&Chip)	Q-Phase Data	-	GPHQ?	n<CR+LF>+d1<CR+LF>+.....+dn<CR+LF> n: Number of output data items (integer) dn: Q-phase data (real number)
I EYE Diagram Q EYE Diagram I/Q EYE Diagram	X-axis data (Chip)	-	GPHCHIP? GPHX?	n<CR+LF>+d1<CR+LF>+.....+dn<CR+LF> n: Number of output data items (integer) dn: Chip data (integer)
I EYE Diagram Q EYE Diagram I/Q EYE Diagram	X-axis data (Chip)	-	GPHCHIP? GPHX?	n<CR+LF>+d1<CR+LF>+.....+dn<CR+LF> n: Number of output data items (integer) dn: Data (integer)
E.V.M. vs Chip Mag Error vs Chip Phase Error vs Chip	Y-axis data	-	GPHY?	n<CR+LF>+d1<CR+LF>+.....+dn<CR+LF> n: Number of output data items (integer) dn: Data (real number)

4.2 GPIB Command Codes

Table 4-12 TRANSIENT Key

Function	Listener Code	Talker Request		Remarks	
		Code	Output Format		
Tx Power	Auto Level Set	AUTOLVL	-	-	
	Parameter Setup				
	Root Nyquist				
	ON	TXRNYQ ON	TXRNYQ?	0: OFF	
	OFF	TXRNYQ OFF		1: ON	
	Trigger Mode				
	INT	TXTRG INT	TXTRG?	0:INT	
	EXT	TXTRG EXT		1:EXT	
	EXT Trigger Slope				
	+	TXTRGSLP RISE	TXTRGSLP?	0:-	
	-	TXTRGSLP FALL		1:+	
EXT Trigger Delay	TXTRGDLY *	TXTRGDLY?	Real number (-5120.000 to 5120.000)		
Average Times	TXAVG *	TXAVG?	Integer (1:OFF to 32)		
Starting the Measurement					
Tx Power	TXPWR	-	-		
Starting the Measurement on the same mode	SI	-	-		
Results					
Tx Power	-	TXPWR?	d1,d2,d3 d1:Tx Power (dBm) d2:Tx Power (W) d3:Peak Factor (dB)		
Power vs Time	Auto Level Set	AUTOLVL	-	-	
	Scale Setup				
	Display Type				
	GRAPH	3GPPTDISP GRP	3GPPTDISP?	0:GRAPH	
	TABLE	3GPPTDISP TBL		1:TABLE	
	Y Scale Upper	3GPPTYUPR *	3GPPTYUPR?	Integer (-20 to 70 dB/ dBm)	
Y Scale Range	3GPPTYRNG *	3GPPTYRNG?	Integer (10 to 50 dB/ dBm)		
Power Unit					
RELATIVE	3GPPTUNIT REL	3GPPTUNIT?	0:ABS POWER		
ABS POWER	3GPPTUNIT ABS		1:RELATIVE		

Table 4-12 TRANSIENT Key

Function	Listener Code	Talker Request		Remarks
		Code	Output Format	
Power vs Time	Parameter Setup			
	Meas Mode			
	PRECISE	3GPPTMEASMD PREC	3GPPTMEASMD?	0:PRECISE
	CONCISE	3GPPTMEASMD CONC		1:CONCISE
	Root Nyquist			
	ON	3GPPTRNYQ ON	3GPPTRNYQ?	0:OFF
	OFF	3GPPTRNYQ OFF		1:ON
	Trigger Mode			
	INT	3GPPTTRG INT	3GPPTTRG?	0:INT
	IF	3GPPTTRG IF		1:IF
	EXT	3GPPTTRG EXT		2:EXT
	Trigger Slope			
	+	3GPPTTRGSLP RISE	3GPPTTRGSLP?	0:-
	-	3GPPTTRGSLP FALL		1:+
Trigger Level	3GPPTTRGLVL *	3GPPTTRGLVL?	Integer (0 to 100)	
Trigger Delay	3GPPTTRGDLY *	3GPPTTRGDLY?	Time	
Meas Length	3GPPTMLEN *	3GPPTMLEN?	Integer (2 to 62)	
Graph Plot Type				
AVERAGE	3GPPTGTYP AVG	3GPPTGTYP?	0:AVERAGE	
PEAK-PEAK	3GPPTGTYP PK		1:PEAK-PEAK	
Omit Transient Section for AVG Power				
ON	3GPPTOMIT ON	3GPPTOMIT?	0:OFF	
OFF	3GPPTOMIT OFF		1:ON	

4.2 GPIB Command Codes

Table 4-12 TRANSIENT Key

Function	Listener Code	Talker Request		Remarks
		Code	Output Format	
Power vs Time	Marker Setup			
	Power Marker 1	3GPPTMKR1 *	3GPPTMKR1?	Integer
	Power Marker 2	3GPPTMKR2 *	3GPPTMKR2?	Integer
	Template Setup			
	Template 1	3GPPTTMP1 *	3GPPTTMP1?	Integer
	Template 2	3GPPTTMP2 *	3GPPTTMP2?	Integer
	Starts measurement			
	Power vs Time	3GPPT	-	-
	Starts measurement in the same mode	SI	-	-
	Measurement results			
	Power Marker 1			
	Peak Factor	-	3GPPTMK1PKF?	Level
	Average Power	-	3GPPTMK1AVG?	Level
	Power Marker 2			
	Peak Factor	-	3GPPTMK2PKF?	Level
Average Power	-	3GPPTMK2AVG?	Level	
Power Marker Ratio	-	3GPPTMKRATIO?	Level	
Read Table Data (When Meas Mode is CON- CISE.)	-	3GPPTTABLE1?	n,d1,d2,...,dn n: The number of output data (integer) d1 to dn: Power values (dBm/dB)	
	-	3GPPTTABLE2?	n<CR+LF>+d1 <CR+LF>+.....+dn <CR+LF> n: The number of output data (integer) dn: Power values (dBm/dB)	

Table 4-12 TRANSIENT Key

Function	Listener Code	Talker Request		Remarks	
		Code	Output Format		
CCDF	Auto Level Set	AUTOLVL	-	-	
	Scale Setup				
	X Scale Max	3GPCCDFXMAX *	3GPCCDFXMAX?	Integer (-20 to 70 dB/dBm)	
	X Scale Range	3GPCCDFXRNG *	3GPCCDFXRNG?	Integer (10 to 50 dB/dBm)	
	Power Unit				
	RELATIVE	3GPCCDFUNIT REL	3GPCCDFUNIT?	0:ABS POWER	
	ABS POWER	3GPCCDFUNIT ABS		1:RELATIVE	
	Parameter Setup				
	Root Nyquist				
	ON	3GPCCDFRNYQ ON	3GPCCDFRNYQ?	0:OFF	
	OFF	3GPCCDFRNYQ OFF		1:ON	
	Trigger Mode				
	INT	3GPCCDFTRG INT	3GPCCDFTRG?	0:INT	
	EXT	3GPCCDFTRG EXT		1:EXT	
	Trigger Slope				
	+	3GPCCDFTRGSLP RISE	3GPCCDFTRGSLP?	0:-	
	-	3GPCCDFTRGSLP FALL		1:+	
	Trigger Delay	3GPCCDFTRGDLY *	3GPCCDFTRGDLY?	Time	
	Meas Length	3GPCCDFMLEN *	3GPCCDFMLEN?	Integer (10000 to 100000000)	
	Trace Write				
	ON	3GPCCDFTRC ON	3GPCCDFTRC?	0:OFF	
	OFF	3GPCCDFTRC OFF		1:ON	
	Starts measurement				
	CCDF	3GPCCDF	-	-	
	Measurement results	SI	-	-	

4.2 GPIB Command Codes

Table 4-12 TRANSIENT Key

Function	Listener Code	Talker Request		Remarks
		Code	Output Format	
CCDF	Measurement results CCDF	-	3GPCCDF?	d1,d2,d3,d4,d5,d6,d7, d8 d1:Peak Factor d2:Average Power d3:10% d4:1% d5:0.1% d6:0.01% d7:0.001% d8:0.0001%
	Marker Position	3GPCCDFMK *	-	Level
	Distribution/Power	-	3GPCCDFMK?	d1,d2 d1:Distribution d2:Power
P-CPICH Power	Auto Level Set	AUTOLVL	-	-
	Parameter Setup Scrambling Code No.	PCPICHSCN*	PCPICHSCN?	Integer (0 to 262142)
		PCPICHSCNHEX*	PCPICHSCNHEX?	Hexadecimal num- ber (0 to 3FFFE)
	Search Mode Primary CPICH	PCPICHSRCHMD PCPICH	PCPICHSRCHMD?	1: Primary CPICH
		SCH(LONG) PCPICHSRCHMD SCHLONG		2: SCH(LONG)
	Meas Frame	PCPICHMSFRM*	PCPICHMSFRM?	Integer (1 to 4)
	Average Times	PCPICHAVG*	PCPICHAVG?	Integer (1:OFF, 2 to 32)
	Starts measurement P-CPICH Power	PCPICH		
	Starts measurement in the same mode	SI		
Measurement results P-CPICH Power Average	-	PCPICHPWAVG?	d1, d2 d1: P-CPICH Power Average (dBm) d2: P-CPICH Power Average (W)	

Table 4-12 TRANSIENT Key

Function		Listener Code	Talker Request		Remarks
			Code	Output Format	
P-CPICH Power	P-CPICH Power Max	-	PCPICHPWMAX?	d1, d2 d1: P-CPICH Power Max (dBm) d2: P-CPICH Power Max (W)	
	P-CPICH Power Min	-	PCPICHPWMIN?	d1, d2 d1: P-CPICH Power Min (dBm) d2: P-CPICH Power Min (W)	
	Frequency Error	-	PCPICHFRERR?	Frequency	
	Tx Power	-	PCPICHTXPWR?	d1, d2 d1: Tx Power (dBm) d2: Tx Power (W)	

Table 4-13 Numeric Keys/Step Keys/Data Knob/Unit Keys (Entering Data)

Function		Listener Code	Talker Request		Remarks
			Code	Output Format	
Entering data	0 to 9	0 to 9	-	-	
	. (Decimal point)	.	-	-	
	GHz	GZ	-	-	
	MHz	MZ	-	-	
	kHz	KZ	-	-	
	Hz	HZ	-	-	
	mV	MV	-	-	
	mW	MW	-	-	
	dB	DB	-	-	
	mA	MA	-	-	
	sec	SC	-	-	
	ms	MS	-	-	
	μs	US	-	-	
	ENTER	ENT	-	-	

4.2 GPIB Command Codes

Table 4-14 Miscellaneous

Function	Listener Code	Talker Request		Remarks
		Code	Output Format	
Miscellaneous Judgment result reading	-	OPF?	0:PASS 1:FAIL(Upper) 2:FAIL(Lower) 3:FAIL(Upper&Lower) 4:Error	
Outputting error number	-	ERRNO?	Integer	
Local	LC	-	-	
Reading GPIB address	-	AD?	Integer (0 to 30)	
Specification of the delimiter				
CR LF <EOI>	DL0	-	-	
LF	DL1	-	-	
<EOI>	DL2	-	-	
CR LF	DL3	-	-	
LF <EOI>	DL4	-	-	
Service request interruption				
ON	S0	-	-	
OFF	S1	-	-	
Status clear	S2	-	-	
Service request mask	RQS *	RQS?	Decimal number corresponding to the SRQ bit	
Outputting ID of the instrument	-	*IDN?	Manufacturer name (character string), instrument type (character string), 0 and revision (character string)	
Initializing the instrument	*RST	-	-	
Clearing the queues related to the status byte	*CLS	-	-	
Accessing the standard event enable register	*ESE *	*ESE?	Decimal number corresponding to the register bits	
Reading or clearing the standard event enable register	-	*ESR?	Decimal number corresponding to the register bits	
Accessing the service request enable register	*SRE *	*SRE?	Decimal number corresponding to the register bits	
Reading the status byte and MSS bit	-	*STB?	Decimal number corresponding to the status byte	

Table 4-14 Miscellaneous

Function		Listener Code	Talker Request		Remarks
			Code	Output Format	
Miscellaneous	Accessing the operation status enable register	OPR *	OPR?	Decimal number corresponding to the register bits	
	Reading or clearing the operation status register	-	OPREVT?	Decimal number corresponding to the register bits	

5 TECHNICAL INFORMATION

5.1 Template Edit Function

In TRANSIENT mode, the user can change template. It is necessary to pay attention when entering template, because the data can be interpreted as a relative or absolute value, depending on the setting of Template Couple to Power ON/OFF in the Config menu.

The PASS/FAIL judgment is performed and then the result is displayed on the screen, when Template ON/OFF in the Template menu is set to ON.

The setting values are retained even if a preset is executed.

5.1.1 Template Setting in the T-Domain Measuring Mode

When Template Couple to Power is set to OFF, template (Y axis data) is interpreted as an absolute value. As a result, the template consists of the data you entered.

Use the Shift X/Y keys to adjust the template position over the measured value.

When Template Couple to Power is set to ON, template (Y axis data) is interpreted as a relative value to the average power.

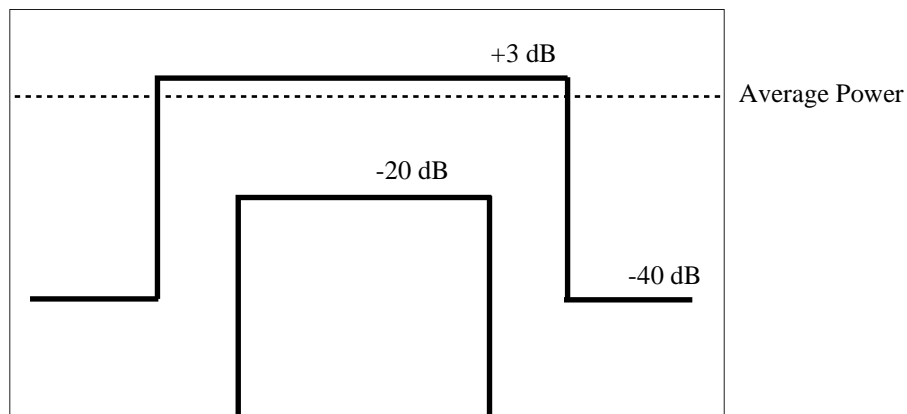

Figure 5-1 Template to Be Set

For example, see Figure 5-2 for setting the upper template used to define the power within the burst period as +3 dB and -40 dB.

5.1 Template Edit Function

Set the template using the relative value to the average power.

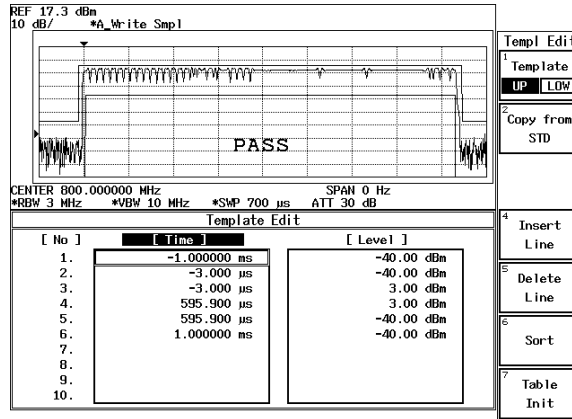

Figure 5-2 Template Settings

When you shift the template to the direction of Y axis using Shift X/Y function while the Template Couple to Power is set to ON, the relative value to the average power is: Relative value (set on the template) + Shifted data on Y axis.

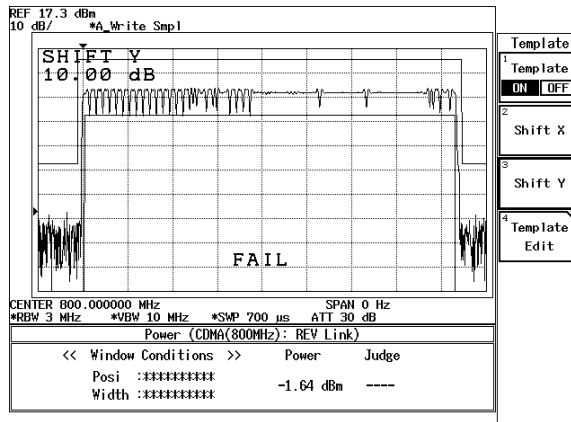

Figure 5-3 Template Shifted Using the Shift Y Function

5.1.2 Template Setting in the F-Domain Measuring Mode

In F-Domain measurement mode, the carrier frequencies depend on the channel numbers. As a result, use the offset frequency from the carrier frequency for template's X axis data.

Set the carrier frequency on the template to 0 Hz so that you can use plus or minus values for the offset frequencies.

The analyzer sets the template by adding the current center frequency to the X value in the template table.

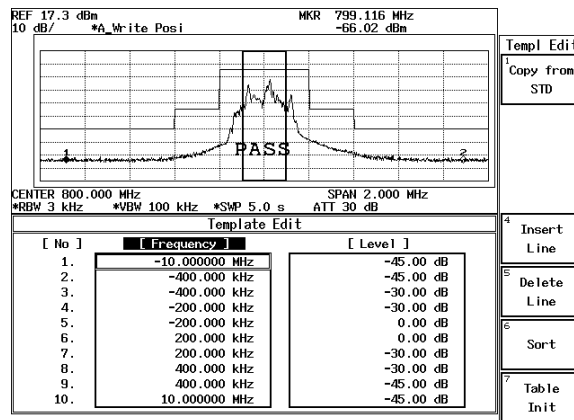

Figure 5-4 Template with the Set Values

In addition, Margin ΔX is used to widen the template data by $\Delta X/2$ to both sides in the plus and minus frequency directions in reference to the 0 Hz on the template.

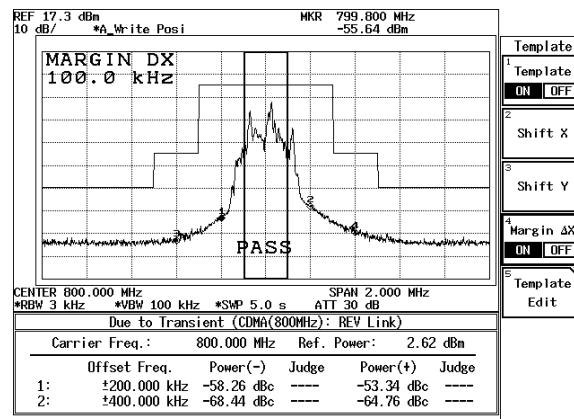

Figure 5-5 Template with Margin Delta X

When Template Couple to Power is set to OFF, template (Y axis data) is interpreted as an absolute value. As a result, the template is made up of the data you entered.

Use the Shift X/Y keys to adjust the template position over the measured value.

When Template Couple to Power is set to ON, template (Y axis data) is interpreted as a relative value to the average power.

When the template is shifted on Y axis using the Shift X/Y function, the relative value to the average power is: Relative value (set on the template) + Shifted data on Y axis.

5.2 Measurement Parameter Settings in Due to Transient, Due to Modulation and Inband Spurious

5.2 Measurement Parameter Settings in Due to Transient, Due to Modulation and Inband Spurious

In TRANSIENT mode, any parameters are compliant with the communication standard when you specify the communication standard. You can also change the measuring frequency and the secondary processing of the measured results.

For the method of changing these, refer to the following

5.2.1 Marker Edit Function

Measurement frequency can be set using Marker Edit in Due to Transient, Due to Modulation or Inband Spurious function (these three functions are found within the Transient mode). In addition, each limit level can be set using Marker Edit.

The setting values are retained even if a preset is executed.

(1) Marker Edit used in the Due to Transient and Due to Modulation

The measuring frequency is set using the offset frequency from a carrier frequency. If you set the offset frequency to 200 kHz, the offset frequencies (+200 kHz and -200 kHz) can be measured. The Normal marker, Integral marker and Root Nyquist marker are available.

Normal marker is used to read the level of the frequency previously set, and the Integral marker is used to calculate the power of the bandwidth whose center frequency is specified by Marker Edit.

When Root Nyquist is selected, calculates the power of the bandwidth to which the Root Nyquist filter is applied. Set the Root Nyquist filter at Config in Parameter Setup.

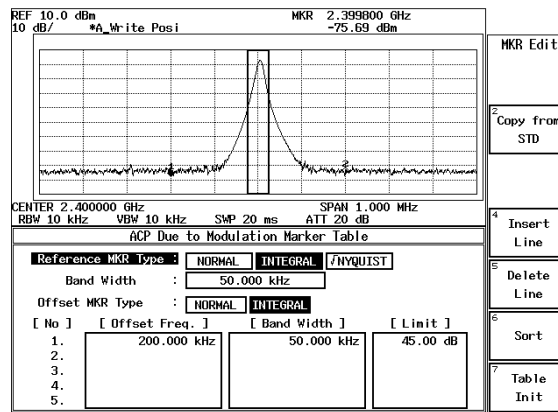

Figure 5-6 Example of Marker Edit Setting (1)

(2) Marker Edit used in the Inband Spurious

Measuring frequency range is set using the offset frequency form the carrier frequency. If you set 3 MHz and 10 MHz, the peak search is performed for two ranges: one of the two offset frequency range is between -3 MHz and -10 MHz; another range is between +3 MHz and +10 MHz.

5.2 Measurement Parameter Settings in Due to Transient, Due to Modulation and Inband Spurious

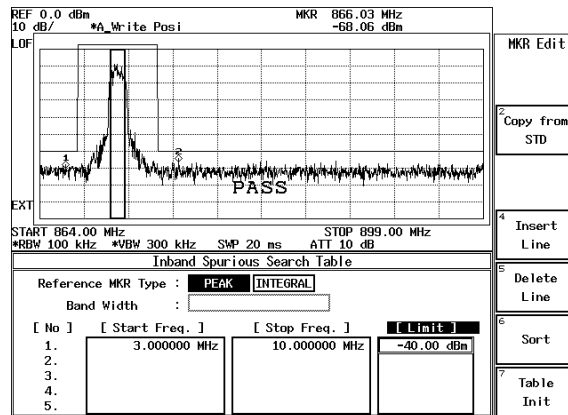

Figure 5-7 Example of Marker Edit Setting (2)

Peak marker is set using the Peak Marker Y Delta soft key in the Config menu.

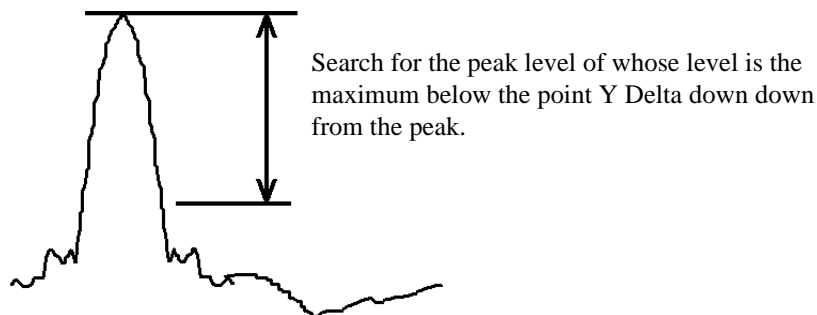

Figure 5-8 Example of Peak Marker Y Delta

5.2.2 Measurement results Using Due to Modulation, Due to Transient and Inband Spurious Modes

In spectrum measurements, there are three methods for displaying results of adjacent or alternate adjacent channel leakage power measurements.

- (1) The measured value displays the absolute level of the marker, which is located at an offset frequency from the carrier frequency.
- (2) The ratio of the absolute level of the marker to the absolute level of the carrier is displayed. The marker point is located at an offset frequency from the carrier frequency.
- (3) The value obtained in (2) is multiplied by the level by the power meter. The calculated value is then displayed.

This method is used when the absolute value of the adjacent channel power cannot be measured. The ratio of the adjacent channel power to the carrier power can be measured only when Detector is set to Posi. However, the absolute level cannot be measured.

5.2 Measurement Parameter Settings in Due to Transient, Due to Modulation and Inband Spurious

To display a measured value in (1), select **MARKER** on the Result: **MARKER/RELATIVE/ABS POWER** menu in the Parameter Setup dialog box.

To display the measured value in (2), select **RELATIVE**.

To display a measured value in (3), select **ABS POWER**. In addition, use the Marker Edit menu to set up measurement conditions for the carrier power. Set the MKR Type to **NORMAL** or **INTEGRAL** in the Reference Marker in order to measure the carrier power.

To measure the power of the bandwidth by integration, Reference MKR Type must be set to **INTEGRAL**.

To measure a point level (marker reading), Reference MKR Type must be set to **NORMAL**.

To measure adjacent channel power, set Offset MKR Type to **NORMAL** or **INTEGRAL**. To measure the carrier power in (2) or (3), there are two methods: one is by setting the Marker Edit to the Reference MKR type (set the Ref Power to **REF MARKER**. Ref Power is in the Parameter Setup dialog box on the config menu); another is to measure power using the DSP (set the Ref Power to **MODULATION**. Ref Power is in the Parameter Setup dialog box on the config menu).

When **REF MARKER** is selected, the carrier power is measured by setting Reference MKR Type in the Marker Edit menu.

When **MODULATION** is selected, the carrier power is measured by Tx Power (Modulation, Tx Power).

When **ABS POWER** of the Result is selected from the Parameter Setup dialog box in the Config Menu, the ratio of Offset MKR to Reference MKR is calculated, the measurement value from Tx Power is multiplied by this ratio. Then, the result will be displayed.

5.2.3 Measurement Result of Inband Spurious

In Spurious measurements, there are three methods:

- (1) After searching for the peak on the trace, the frequency and level at the marker are displayed.
- (2) After searching for the peak on the trace, the ratio of the marker level to the carrier level is displayed.
- (3) The calculated level, which is calculated using the result obtained in (2) and the level on the power meter is displayed.

To display the measured value in (1), select **MARKER** on the Result: **MARKER/RELATIVE/ABS POWER** menu in the Parameter Setup dialog box. And also, to display the measured value in (2), select **RELATIVE**; for the (3), select **ABS POWER**. The measurement conditions for the carrier power is set up using the Marker Edit menu. To measure the carrier power, set Reference MKR Type to **PEAK** or **NORMAL**.

To measure the carrier power at the specified frequency, **NORMAL** is set; and to measure the carrier power at the peak on the trace, **PEAK** is set.

To measure the carrier power in (2) or (3), there are two methods: one is by setting the instrument to the Reference MKR type in the Marker Edit menu; another is by the DSP.

When Ref Power is set to **REF MARKER**, the carrier power is measured by Reference MKR Type in the Marker Edit menu.

When Ref Power is set to **MODULATION**, the carrier power is measured by the Tx Power (Modulation, Tx Power).

5.3 Mag Error (Magnitude Error)

Mag Error is defined as shown in Figure 5-9, and the value is calculated using the following formula.

$$\text{Magnitude Error} = \sqrt{\frac{\sum_i^K (\sqrt{\text{Im}(i)^2 + \text{Qm}(i)^2} - \sqrt{\text{Ir}(i)^2 + \text{Qr}(i)^2})^2}{\sum_i^K (\text{Ir}(i)^2 + \text{Qr}(i)^2)}}} \times 100$$

Im (i), Qm (i): Measured values
 Ir (i), Qr (i): Reference values
 i: Chip number
 K: Wavelength to be measured

5.4 Phase Error

Phase Error is defined as shown in Figure 5-9, and the value is calculated using the following formula.

$$\text{Phase Error} = \sqrt{\frac{\sum_i^K \{ \tan^{-1} (\text{Qm}(i) / \text{Im}(i)) - \tan^{-1} (\text{Qr}(i) / \text{Ir}(i)) \}^2}{K}}$$

Im (i), Qm (i): Measured values
 Ir (i), Qr (i): Reference values
 i: Chip number
 K: Wavelength to be measured

5.5 E.V.M. (Error Vector Magnitude)

5.5 E.V.M. (Error Vector Magnitude)

E.V.M. is defined as shown in Figure 5-9, and the value is calculated using the following formula.

$$\text{Error Vector Magnitude} = \sqrt{\frac{\sum_i^K \{ (I_m(i) - I_r(i))^2 + (Q_m(i) - Q_r(i))^2 \}}{\sum_i^K \{ I_r(i)^2 + Q_r(i)^2 \}}} \times 100$$

$I_m(i), Q_m(i):$	Measured values
$I_r(i), Q_r(i):$	Reference values
$i:$	Chip number
$K:$	Wavelength to be measured

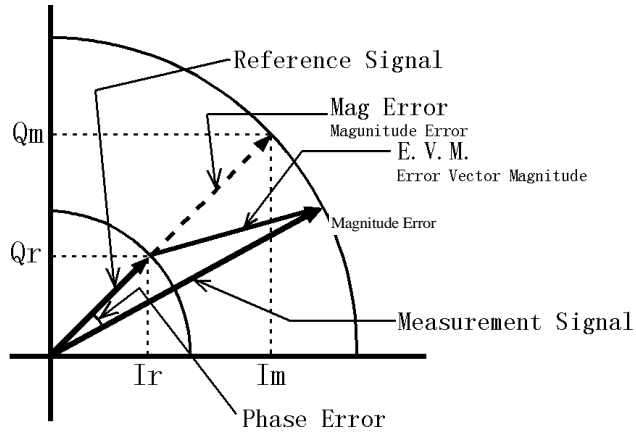

Figure 5-9 Mag Error, Phase Error, E.V.M.

5.6 Waveform Quality

Waveform Quality (ρ) can be obtained using the following calculation expression.

$$\rho = \frac{\left| \sum_i^K (\text{Im}(i) + j\text{Qm}(i)) \cdot (\text{Ir}(i) - j\text{Qr}(i)) \right|^2}{\sum_i^K (\text{Ir}(i)^2 + \text{Qr}(i)^2) \sum_i^K (\text{Im}(i)^2 + \text{Qm}(i)^2)}$$

$\text{Im}(i), \text{Qm}(i)$:	Measured values
$\text{Ir}(i), \text{Qr}(i)$:	Reference values
i :	Chip number
K :	Wavelength to be measured

5.7 About a Code Domain Power coefficient

The code domain power coefficient for the channel A can be obtained using the following calculation expression.

$$\frac{\sum_k^N \left| \sum_i^M (\text{Im}(k \cdot M + i) + j\text{Qm}(k \cdot M + i)) \cdot (\text{Ir}(k \cdot M + i) - j\text{Qr}(k \cdot M + i)) \right|^2}{\sum_i^M (\text{Ir}(i)^2 + \text{Qr}(i)^2) \sum_k^N \sum_i^M (\text{Im}(k \cdot M + i)^2 + \text{Qm}(k \cdot M + i)^2)}$$

$\text{Im}(i), \text{Qm}(i)$:	Measured values
$\text{Ir}(i), \text{Qr}(i)$:	Reference values
i :	Chip number
k :	Symbol number
M :	One symbol length of channel A (number of chips)
N :	Number of symbols to be measured

5.8 About the Carrier Frequency Error of QPSK

This section describes the carrier frequency error of QPSK.

When LINK is set to UPLINK in STD Setup, the carrier frequency measurement range is limited for the purpose of measuring a special HPSK signal (when the levels of I and Q are the same and the signal is equivalent to the QPSK signal).

This measurement uses a range of 2560 chips away from the trigger for the carrier frequency measurement in addition to the modulation accuracy calculation range specified by Meas range.

As a result, this measurement includes the following features as compared with the measurement with LINL set to DOWNLINK.

1. The carrier frequency measurement range is limited.
2. Since this measurement uses a period other than the modulation accuracy calculation period for the carrier frequency measurement, the carrier frequency error may become large when an application is used to measure the modulation accuracy only for the period where the burst signal is turned on.

5.9 Block Diagram

5.9 Block Diagram

This section shows the block diagram for the modulation analysis hardware.

The Figure 5-10 shows the modulation analysis part. Therefore the spectrum analyzer part is simplified. The area inside the double lines is the block diagram for the spectrum analyzer, and the part outside that area represents the modulation analysis hardware.

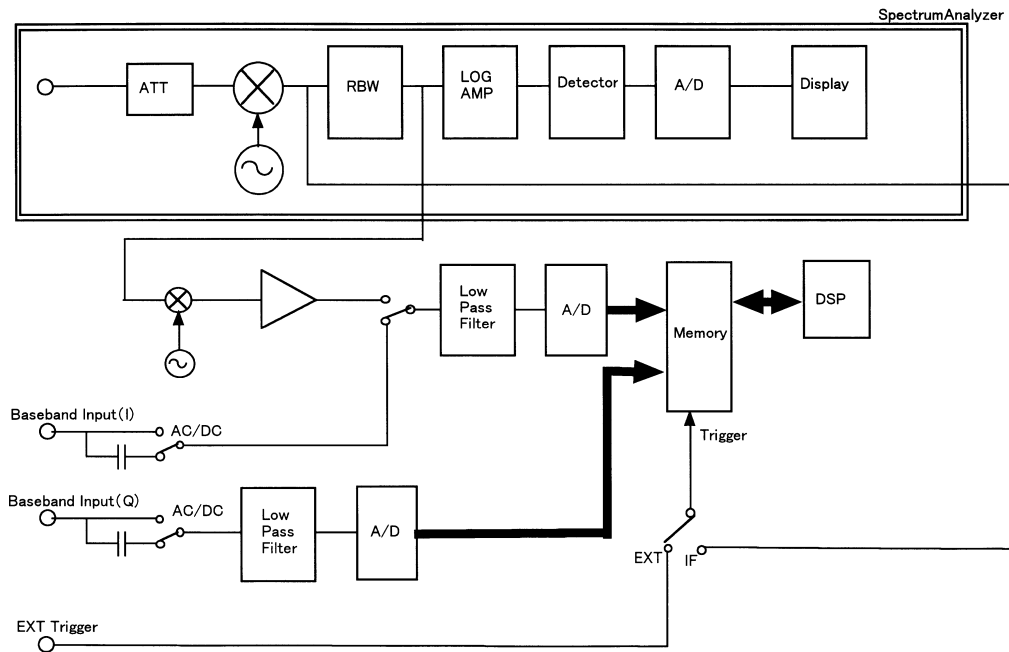

Figure 5-10 Block Diagram

6 PERFORMANCE VERIFICATION TEST(3GPP)

6.1 General

6.1.1 Introduction

This chapter provides R3267 Series OPT62 performance verification test procedures complied with 3GPP standards, item by item as listed in Table 6-1.

Performance verification test will be carried out under following condition.

Temperature range: 20 °C to 30 °C

Relative Humidity: 85% or less

Table 6-1 Performance Verification Items

No.	Mode	Test Items
6.2.1	Down Link Measurement in RF Input	Waveform Quality Accuracy (ρ)
		Carrier Frequency Accuracy
		Code Domain Power
		Modulation Accuracy
6.2.2	Up Link Measurement in RF Input	Waveform Quality Accuracy (ρ)
		Carrier Frequency Accuracy
		Modulation Accuracy
6.2.3	QPSK Measurement in RF Input	Waveform Quality Accuracy (ρ)
		Carrier Frequency Accuracy
		Modulation Accuracy
6.2.4	Down Link Measurement in IQ Input	Modulation Accuracy
6.2.5	Up Link Measurement in IQ Input	Modulation Accuracy
6.2.6	QPSK Measurement in IQ Input	Modulation Accuracy
6.2.7	Simplified Performance Check	Waveform Quality Accuracy (ρ)
		Carrier Frequency Accuracy
		Modulation Accuracy

6.1 General

6.1.2 Test Equipment

The Table 6-2 lists recommended test equipment.

The equipment needed to perform all of the performance test.

Equipment lists for individual tests are provided in each performance verification test.

NOTE:

1. *The R3267 Series with OPT62 to be tested should be warm up for at least 30 minutes before starting test.*
2. *Make sure that the test equipment used meets its own published specifications.*
3. *Any equipment that meets the critical specifications given in the table can be substituted for recommended models.*

Table 6-2 Equipment List

1	Arbitrary Waveform Generator	No. of Output Channels: 3 ch required Capable to assign; I CH Signal Output at CH1 Q CH Signal Output at CH2 Trigger Signal at CH3	AWG2021	Tektronix	SG1
2	IQ Modulation Signal Generator	Frequency Range: 30MHz to 3GHz IQ Modulation Bandwidth: >5 MHz ρ :>0.999	SMIQ03	Rohde & Schwartz	SG2
3	RF Cable	BNC(m)-BNC(m), 50W	MI-09	Advantest	-
4	Adapter	Type N(m)-BNC(f), 50W	JUG-201-U	Advantest	-

NOTE:

**The IQ level and DC offset of both SG1 and SG2 must be matched.*

Total performance of SG1 with SG2 must cover the R3267 Series tested specification.

6.1.3 Specifications Required for Test Signals

Table 6-3 provides the specifications required for performance verification test signals based on the TS 25.211 V3.6.0 and TS 25.213 V3.5.0 of the 3GPP Standards.

Table 6-3 Specifications Required for Test Signals

No.	Test Signal	Critical Specification	Usage			
1	Base Station	Scrambling Code No.0, Level takes 0 dB for Total Power		In Section 6.2.1 & Section 6.2.4		
		Channel Name	Transfer Rate		Channelization No.	Level
		Primary CPICH	15ksps		0	-9.03dB
		P-CCPCH	15ksps		1	-9.49dB
		SCH	15ksps		-	-19.03dB
		DPCH	30ksps		2	-6.02dB
		DPCH	30ksps		3	-6.02dB
		DPCH	30ksps		4	-6.02dB
2	Mobile Station	Scrambling Code No.1, Level takes 0 dB for Total Power		In Section 6.2.2 & Section 6.2.5		
		Channel Name	Transfer Rate		Channelization No.	Level
		DPDCH(I-ch)	60ksps		16	-0.85dB
		DPCCH(Q-ch)	15ksps		0	-7.47dB
3	Mobile Station	Modulation:QPSK Symbol rate:3.84Msymbol/sec. Filter Type:Root Nyquist Roll Off: $\alpha=0.22$	In Section 6.2.3 & Section 6.2.6			
4	QPSK Signal Comply with 3GPP Standard	Modulation:QPSK Symbol rate:3.84Msymbol/sec. Filter Type:Root Nyquist Roll Off: $\alpha=0.22$	In Section 6.2.7			

Figure 6-1 shows the timing chart of trigger signal with No.1, N0.2 and No.3 listed in Table 6-3.

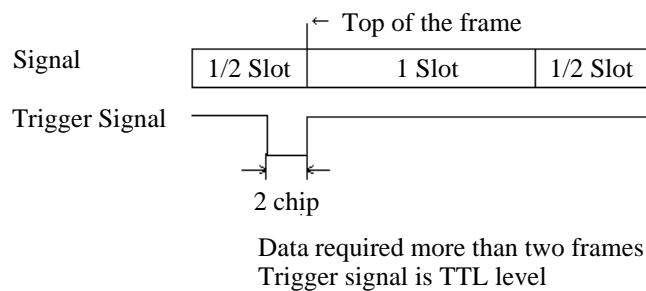

Figure 6-1 Timing Chart

6.1 General

6.1.4 Calibration Cycle

The performance verifications test should be used to check the spectrum analyzer against its specifications once a year recommended.

6.1.5 Performance Verification Test Record Sheets

The performance verification test record sheets and performance check record sheets are provided at the end of this chapter.

The test record lists test specification and acceptable limits.

Recommend that make a copy of this table, record the complete test results on the copy, and keep the copy for calibration test record.

This record could prove invaluable in tracking gradual changes in test result over long periods of the time.

6.1.6 Performance Verification Procedure

Typeface conventions used in this manual.

- Panel keys and soft keys are printed in a contrasting type style to make them stand out from the text as follows:
Panel keys: Boldface type Example: **FREQ, FORMAT**
Soft keys: Boldface and Italic Example: ***Center, Trace Detector***
- When a series of key operations are described using a comma between two keys.
- There are various soft menus used to switch between two states such as ON/OFF and AUTO/MNL. For example, when turning off the ***Display ON/OFF*** function, the annotation "***Display ON/OFF*** (OFF)" is used. When switching the RBW AUTO/MNL function to MNL, the annotation "***RBW AUTO/MNL***(MNL)" is used.

6.2 Performance Verification Test Procedure

6.2.1 Down Link Measurement in RF Input

(1) Description

Test waveform quality accuracy, carrier frequency accuracy, modulation accuracy and code domain power accuracy in Down Link measurement mode of RF input.

(2) Specification

Waveform Quality Accuracy (ρ): ≥ 0.998
 Carrier Frequency Accuracy: $\leq \pm 10$ Hz
 Modulation Accuracy: $\leq 3\%$
 Code Domain Power Accuracy: ± 0.1 dB

(3) Equipment used

Arbitrary Waveform Generator: SG1
 IQ Modulation Signal Generator: SG2
 RF Cable: BNC (m)-BNC (m)
 Adapter: N (m)-BNC (f)

(4) Setup

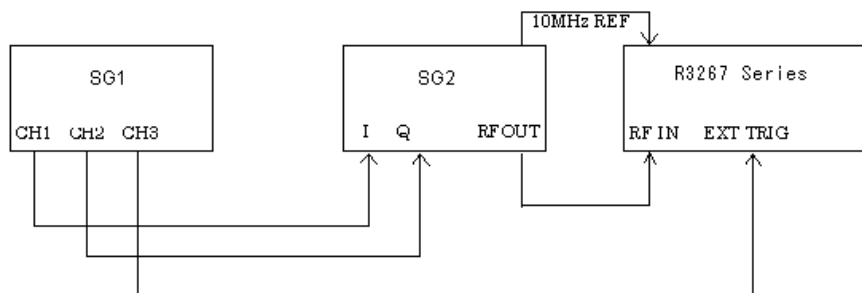

Figure 6-2 Setup of Down Link Measurement (RF Input)

(5) Procedure

1. Connect equipment as shown in Figure 6-2.
2. On the SG1, set controls to generate the signal complied with No.1 (Base Station) signal listed in Table 6-3 at CH1 and CH2.
3. On the SG1, set controls to generate trigger signal at CH3.

6.2 Performance Verification Test Procedure

4. On the SG2, set controls as follows;
 - Modulation: External IQ Modulation
 - Frequency: 2 GHz
 - Output Level: 0 dBm

5. On the R3267 Series, set controls as follows;
 - Center Frequency: 2 GHz
 - Input: RF
 - Measurement: Down Link

6. On the R3267 Series, set the measurement parameters as shown in Figure 6-3.

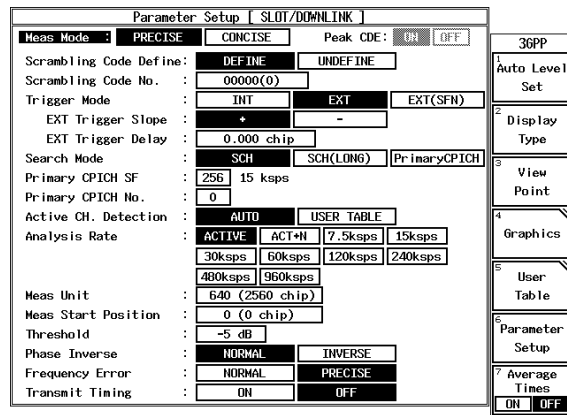

Figure 6-3 Setting of Measurement Parameters for Down Link (RF Input)

7. On the R3267 Series, press **DC CAL** and **AUTO LEVEL** to perform dc calibration and auto level.

8. On the R3267 Series, press **SINGLE** for single sweep.

9. After single sweep has completed, record the measurement result in the performance verification test record sheets.

6.2.2 Up Link Measurement in RF Input

- (1) Description

Test waveform quality accuracy, carrier frequency accuracy and modulation accuracy in Up Link measurement of RF input.

- (2) Specification

Waveform Quality Accuracy (ρ): ≥ 0.999
 Carrier Frequency Accuracy: ≤ ± 10 Hz
 Modulation Accuracy: ≤ 3%

(3) Equipment used

Arbitrary Waveform Generator:	SG1
IQ Modulation Signal Generator:	SG2
RF Cable:	BNC (m)-BNC (m)
Adapter:	N (m)-BNC (f)

(4) Setup

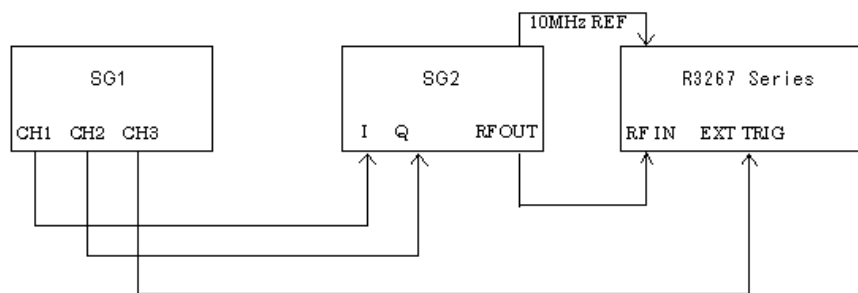
**Figure 6-4 Setup of Up Link Measurement (RF Input)**

(5) Procedure

1. Connect equipment as shown in Figure 6-4.
2. On the SG1, set controls to generate the signal complied with No.2 (Mobile Station) signal listed in Table 6-3 at CH1 and CH2.
3. On the SG1, set controls to generate trigger signal at CH3.
4. On the SG2, set controls as follows;

Modulation:	External IQ Modulation
Frequency:	2 GHz
Output Level:	0 dBm
5. On the R3267 Series, set controls as follows;

Center Frequency:	2 GHz
Input:	RF
Measurement:	Up Link

6.2 Performance Verification Test Procedure

- On the R3267 Series, set the measurement parameters as shown in Figure 6-5.

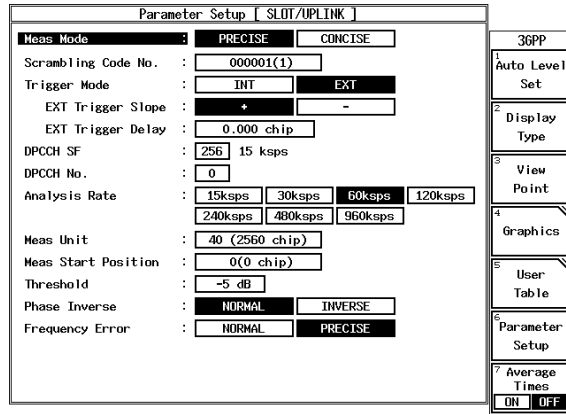

Figure 6-5 Setting of Measurement Parameters for Up Link (RF Input)

- On the R3267 Series, press **DC CAL** and **AUTO LEVEL** to perform dc calibration and auto level.
- On the R3267 Series, press **SINGLE** for single sweep.
- After single sweep has completed, record the measurement result in the performance verification test record sheets.

6.2.3 QPSK Measurement in RF Input

- Description

Test waveform quality accuracy, carrier frequency accuracy and modulation accuracy in QPSK measurement of RF input.

- Specification

Waveform Quality Accuracy (ρ): ≥ 0.999
 Carrier Frequency Accuracy: $\leq \pm 30$ Hz
 Modulation Accuracy: $\leq 3\%$

- Equipment used

Arbitrary Waveform Generator: SG1
 IQ Modulation Signal Generator: SG2
 RF Cable: BNC (m)-BNC (m)
 Adapter: N (m)-BNC (f)

(4) Setup

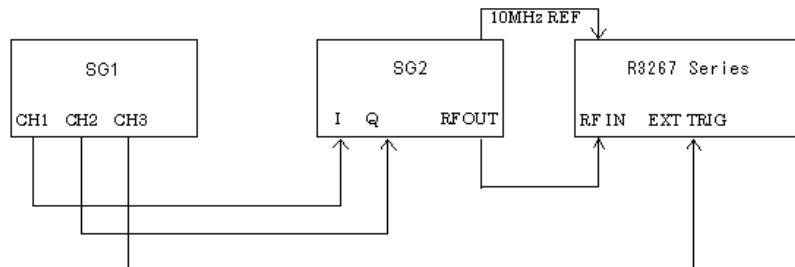

Figure 6-6 Setup of QPSK Measurement (RF Input)

(5) Procedure

1. Connect equipment as shown in Figure 6-6.
2. On the SG1, set controls to generate the signal complied with No.3 (Mobile Station) signal listed in Table 6-3.
3. On the SG1, set controls to generate trigger signal at CH3.
4. On the SG2, set controls as follows;

Modulation:	External IQ Modulation
Frequency:	2 GHz
Output Level:	0 dBm
5. On the R3267 Series, set controls as follows;

Center Frequency:	2 GHz
Input:	RF
Measurement:	QPSK
6. On the R3267 Series, set the measurement parameters as shown in Figure 6-7.

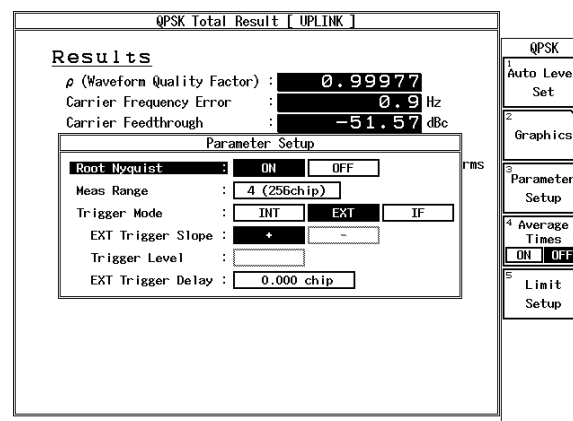

Figure 6-7 Setting of Measurement Parameters for QPSK (RF Input)

6.2 Performance Verification Test Procedure

7. On the R3267 Series, press **DC CAL** and **AUTO LEVEL** to perform dc calibration and auto level.
8. On the R3267 Series, press **SINGLE** for single sweep.
9. After single sweep has completed, record the measurement result in the performance verification test record sheets.

6.2.4 Down Link Measurement in IQ Input

(1) Description

Test modulation accuracy in Down Link measurement of IQ input.

(2) Specification

Modulation Accuracy: $\leq 3\%$

(3) Equipment used

Arbitrary Waveform Generator: SG1
 RF Cable: BNC(m)-BNC(m)
 Adapter: N(m)-BNC(f)

(4) Setup

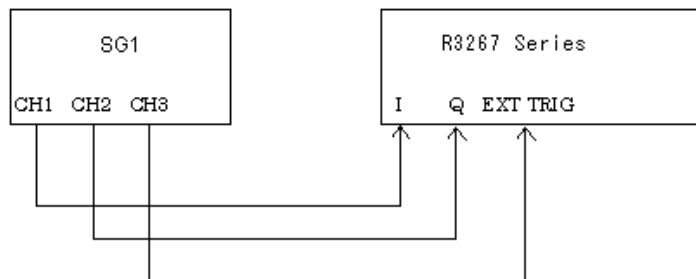

Figure 6-8 Setup of Down Link Measurement (IQ Input)

(5) Procedure

1. Connect equipment as shown in Figure 6-8.
2. On the SG1, set controls to generate the signal complied with No.1 (Base Station) signal listed in Table 6-3.
 Set output level to 0.8 Vp-p for CH1 and CH2, both signals must be balanced.
3. On the R3267 Series, set controls as follows;

Input:	IQ
Measurement:	Down Link

- On the R3267 Series, set the measurement parameters as shown in Figure 6-9.

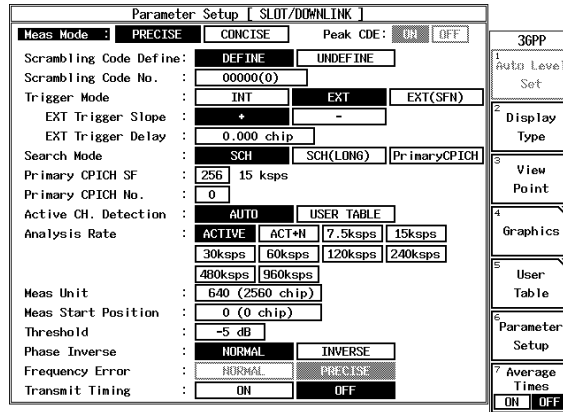

Figure 6-9 Setting of Measurement Parameters for Down Link (IQ Input)

- On the R3267 Series, press **DC CAL** to perform dc calibration.
- On the R3267 Series, press **SINGLE** for single sweep.
- After single sweep has completed, record the result in the performance check record sheets.

6.2.5 Up Link Measurement in IQ Input

- Description

Test modulation accuracy in Up Link measurement of IQ input.

- Specification

Modulation Accuracy: $\leq 3\%$

- Equipment used

Arbitrary Waveform Generator: SG1

RF Cable: BNC(m)-BNC(m)

Adapter: N(m)-BNC(f)

6.2 Performance Verification Test Procedure

(4) Setup

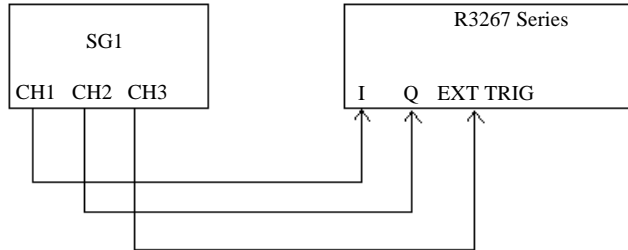

Figure 6-10 Setup of Up Link Measurement (IQ Input)

(5) Procedure

1. Connect equipment as shown in Figure 6-10.
2. On the SG1, set controls to generate the signal complied with No.2 (Mobile Station) signal listed in Table 6-3. Set output level to 0.8 Vp-p for CH1 and CH2, both signals must be balanced.
3. On the R3267 Series, set controls as follows:
 Input: IQ
 Measurement: Up Link
4. On the R3267 Series, set the measurement parameters as shown in Figure 6-11.

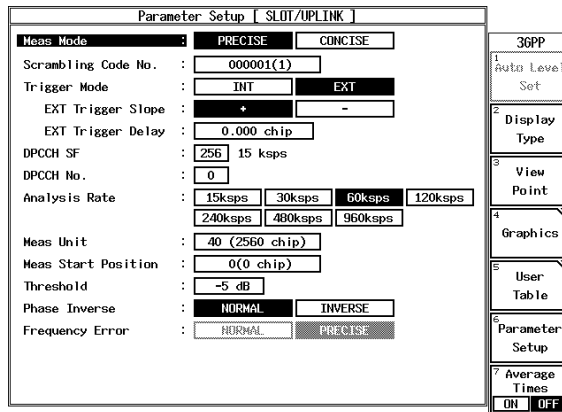

Figure 6-11 Setting of Measurement Parameters for Up Link (IQ Input)

5. On the R3267 Series, press **DC CAL** to perform dc calibration.
6. On the R3267 Series, press **SINGLE** for single sweep.
7. After single sweep has completed, record the result in the performance check record sheets.

6.2.6 QPSK Measurement in IQ Input

(1) Description

Test modulation accuracy in QPSK measurement of IQ input.

(2) Specification

Modulation Accuracy: $\leq 3\%$

(3) Equipment used

Arbitrary Waveform Generator: SG1

RF Cable: BNC(m)-BNC(m)

Adapter: N(m)-BNC(f)

(4) Setup

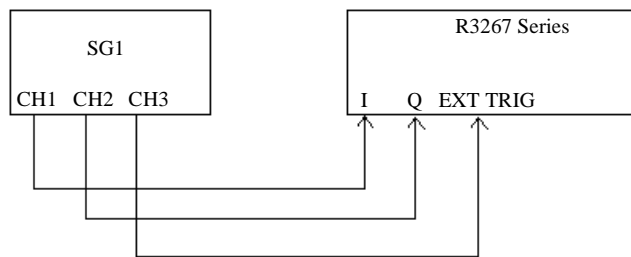

Figure 6-12 Setup of QPSK Measurement (IQ Input)

(5) Procedure

1. Connect equipment as shown in Figure 6-12.
2. On the SG1, set controls to generate the signal complied with No.3 (Mobile Station) signal listed in Table 6-3.
Set output level to 0.8 Vp-p for CH1 and CH2, both signals must be balanced.
3. On the R3267 Series, set controls as follows;

Input:	IQ
Measurement:	QPSK

6.2 Performance Verification Test Procedure

4. On the R3267 Series, set the measurement parameters as shown in Figure 6-13.

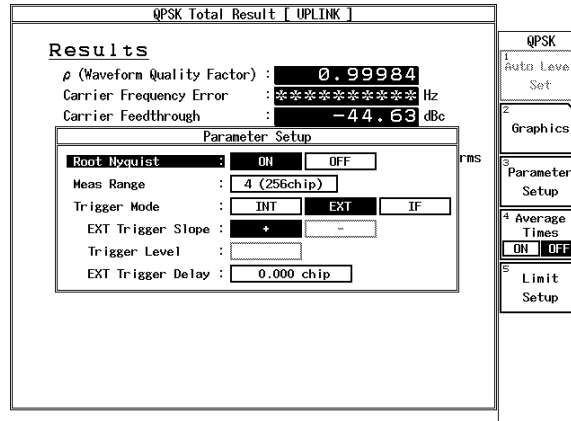

Figure 6-13 Setting of Measurement Parameters for QPSK (IQ Input)

5. On the R3267 Series, press **DC CAL** to perform dc calibration.
6. On the R3267 Series, press **SINGLE** for single sweep.
7. After single sweep has completed, record the result in the performance check record sheets.

6.2.7 Simplified Performance Check

- (1) Description

This section provides performance check procedure for OPT62 complied with 3GPP standards by using QPSK signal.

Check waveform quality, carrier frequency accuracy and modulation accuracy.

- (2) Specification

Waveform Quality Accuracy (ρ):	≥ 0.999
Carrier Frequency Accuracy:	$\leq \pm 30$ Hz
Modulation Accuracy:	$\leq 3\%$

- (3) Equipment used

Arbitrary Waveform Generator:	SG1
RF Cable:	BNC(m)-BNC(m)
Adapter:	N(m)-BNC(f)

(4) Setup

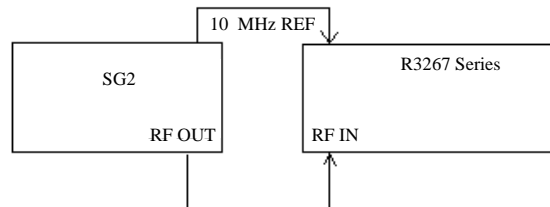

Figure 6-14 Setup of Simplified Performance Check

(5) Procedure

1. Connect equipment as shown in Figure 6-14.
2. On the SG2, set controls complied with No.4 signal listed in Table 6-3.
3. On the SG2, set controls as follows;
 - Frequency: 2 GHz
 - Output Level: 0 dBm
4. On the R3267 Series, set controls as follows;
 - Center Frequency: 2 GHz
 - Input: RF
 - Measurement: QPSK
5. On the R3267 Series, set measurement parameters as shown in Figure 6-15.

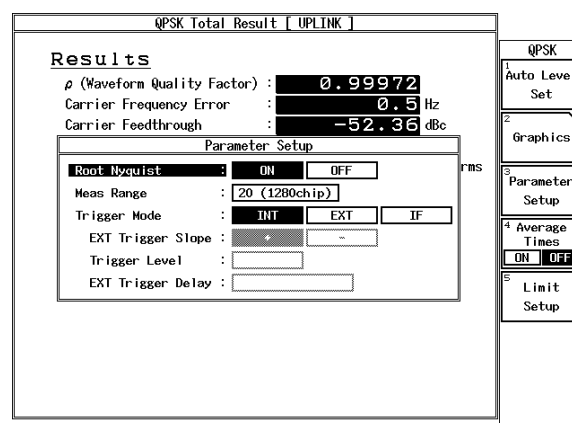

Figure 6-15 Setting of Measurement Parameters for QPSK (RF Input)

6. On the R3267 Series, press **SINGLE** for single sweep.
7. After single sweep has completed, record the result in the performance check record sheets.

6.3 Performance Verification Test Record Sheet

6.3 Performance Verification Test Record Sheet

Model: OPT3264/67/73+62

S/N:

(1) Down Link Measurement in RF Input

Test Items		Specification			Result
		Min.	Measured Value	Max.	Pass/Fail
Waveform Quality(ρ)		0.998		NA	
Carrier Frequency Accuracy		-10 Hz		+10 Hz	
Modulation Accuracy		NA		3%	
Code Domain Power Measurement Accuracy	Ch No.				
	0	-9.13dB		-8.93dB	
	1	-9.59dB		-9.39dB	
	2	-6.12dB		-5.92dB	
	3	-6.12dB		-5.92dB	
	4	-6.12dB		-5.92dB	

(2) Up Link Measurement in RF Input

Test Items		Specification			Result
		Min.	Measured Value	Max.	Pass/Fail
Waveform Quality(ρ)		0.999		NA	
Carrier Frequency Accuracy		-10 Hz		+10 Hz	
Modulation Accuracy		NA		3%	

(3) QPSK Measurement in RF Input

Test Items		Specification			Result
		Min.	Measured Value	Max.	Pass/Fail
Waveform Quality(ρ)		0.999		NA	
Carrier Frequency Accuracy		-30 Hz		+30 Hz	
Modulation Accuracy		NA		3%	

(4) Down Link Measurement in IQ Input

Test Items	Specification			Result
	Min.	Measured Value	Max.	Pass/Fail
Modulation Accuracy	NA		3%	

(5) Up Link Measurement in IQ Input

Test Items	Specification			Result
	Min.	Measured Value	Max.	Pass/Fail
Modulation Accuracy	NA		3%	

(6) QPSK Measurement in IQ Input

Test Items	Specification			Result
	Min.	Measured Value	Max.	Pass/Fail
Modulation Accuracy	NA		3%	

6.4 Performance Check Record Sheet

6.4 Performance Check Record Sheet

Model: OPT3264/67/73+62

S/N:

Test Items	Specification			Result
	Min.	Measured Value	Max.	Pass/Fail
Waveform Quality(ρ)	0.999		NA	
Carrier Frequency Accuracy	-30 Hz		+30 Hz	
Modulation Accuracy	NA		3%	

7 SPECIFICATIONS

(1) Modulation Analysis Compliance

Third Generation Partnership Project (3GPP)

The applicable system conforms to the following specifications.

TS 25.101 V 3.6.0

25.104 V 3.6.0

25.211 V 3.6.0

25.213 V 3.5.0

(2) System Parameters

Characteristics	Specification
Measurement frequency range	30 MHz to 3.0 GHz
Input level range	-30 dBm to +30 dBm (Total power in ATT AUTO) -40 dBm to +30 dBm (Total power in ATT MNL)
Carrier frequency accuracy	$\pm(\text{Reference accuracy} \times \text{Carrier frequency} + 30 \text{ Hz})$ QPSK modulation analysis mode (Within Carrier frequency ± 1 kHz) $\pm(\text{Reference accuracy} \times \text{Carrier frequency} + 10 \text{ Hz})$ 3GPP modulation analysis mode (Within Carrier frequency ± 1 kHz, in PRECISE mode)
Modulation accuracy	Residual vector error: < 3% Measurement range: 0% to 17.5% Accuracy: $\pm 2\%$
Chip rate	3.84 Mcps
Rolloff factor	0.22
Available level offset setting	0 to 100.0 dB
Channel power measurement	Integrating power over the set window zone

- QPSK modulation analysis mode

Characteristics	Specification
Waveform quality	Measurement accuracy: < 0.001
Result display	ρ (Waveform Quality Factor) Carrier Frequency Error Carrier Feedthrough Magnitude Error Phase Error Error Vector Magnitude
Waveform display	Constellation display (Line, Dot or Line & Chip) EYE Diagram (I, Q or I&Q) Vector error, magnitude error, Phase error vs. Chip number display

7 SPECIFICATIONS

- 3GPP modulation analysis mode (DOWNLINK)

Characteristics	Specification
Waveform quality	Measurement accuracy: < 0.002
Code domain power	Measurement accuracy: < ± 0.1 dB
Result display	ρ (Waveform Quality Factor) τ (Time Alignment Error) Carrier Frequency Error I/Q Origin Offset Magnitude Error Phase Error Modulation Accuracy Code Domain Power
Waveform display	Constellation display (Line, Dot, Line & Chip or Line & Symbol) EYE Diagram (I, Q or I&Q), SCH Power Displays the vector error and magnitude error or phase error vs. chip or symbol number. Constellation and EYE Diagram turned by 45°
Display of others	slot, Scrambling Code No., Scrambling Code Group No., SCH Power, Power Ratio R-SCH:S-SCH

(For the signals with the following ratio of levels:
Primary CPICH: P-CCPCH: SCH: DCP *3 channels = 1: 0.9: 0.1: 2: 2: 2)

- 3GPP modulation analysis mode (UPLINK)

Characteristics	Specification
Waveform quality	Measurement accuracy: <0.001
Result display	ρ (Waveform Quality Factor) τ (Time Alignment Error) Carrier Frequency Error I/Q Origin Offset Magnitude Error Phase Error Modulation Accuracy Code Domain Power
Woreform display	Constellation display (Line, Dot, or Line & Chip) EYE Diagram (I, Q or I&Q) Displays the vector error, magnitude error or phase error vs. chip number and vector error vs. symbol number. Constellation and EYE Diagram turned by 45°
Display of others	slot

(For the signals with the following ratio of levels:
I-channel (DPDCH) : Q-channel (DPCCH) = 0.82 : 0.18)

- I/Q input

Characteristics	Specification
Connectors	BNC female (rear panel)
Input Impedance	50 Ω (nominal)
Coupling	DC or AC coupling
Input level range	0.25V - 0.9Vp-p (\pm 0.47V or less)
Modulation accuracy	Residual vector error:< 3%
Result display and waveform display	Both comply with the modulation analysis

APPENDIX

A.1 Messages

In this section, the messages that are displayed while the analyzer is being used are described.

Code	Messages	Description
700	System Error. Cannot allocate the required memory.	Fatal Error occurred. Data area for the calculation is insufficient on the memory. Contact a sales representative.
701	System Error. Clock is not operational.	Fatal Error occurred. System clock is not in operation. Contact a sales representative.
702	Modulation Gain CAL error. Check 30 MHz CAL signal for connection.	-
703	Modulation DC CAL error. Remove input signals and try again.	-
704	Time Out! No Trigger Detected	Time out error on the trigger signal occurred. Check the trigger settings.
705	Input Level is out of Range. Check the Ref. level.	-
706	No graph data. Execute measurement.	-
707	Input level is too low. Adjust the Ref. level.	-
708	System Error. Contact qualified engineer.	-
710	Auto Level completed !	-
711	Auto Level Set can not be succeed. Signal level is not stable.	-
712	Cannot execute measurement. Because ρ is too low.	-
721	Modulation Gain CAL error!(#100) Check 30 MHz CAL signal for connection.	-

A.1 Messages

Code	Messages	Description
722	Modulation Gain CAL error!(#200) Check 30 MHz CAL signal for connection.	-
723	Modulation Gain CAL error!(#300) Check 30 MHz CAL signal for connection.	-
724	Modulation Gain CAL error!(#110) Check 30 MHz CAL signal for connection.	-
725	Modulation Gain CAL error!(#120) Check 30 MHz CAL signal for connection.	-
726	Modulation Gain CAL error!(#210) Check 30 MHz CAL signal for connection.	-
727	Modulation Gain CAL error!(#220) Check 30 MHz CAL signal for connection.	-
728	Modulation Gain CAL error!(#310) Check 30 MHz CAL signal for connection.	-
729	Modulation Gain CAL error!(#320) Check 30 MHz CAL signal for connection.	-
738	Cannot execute measurement. Because Meas Unit is too small.	-
739	Incorrect channel settings. Reset the channel SF and number.	-
740	Cannot measurement baseband signal. This function is available to RF input only.	
742	This function is available to DOWN-LINK only. Set Link to DOWNLINK.	
743	Cannot allocate sufficient memory. Set Power Unit to RELATIVE.	-
750	Handshake error occurred to DSP. Contact qualified engineer.	-

Code	Messages	Description
751	Cannot Detect Mod. DSP board. Contact qualified engineer.	-
795	System Error. Memory test failed. (#0)	A memory error was detected. Contact a sales representative.
796	System Error. Memory test failed. (#1)	A memory error was detected. Contact a sales representative.
797	System Error. Memory test failed. (#2)	A memory error was detected. Contact a sales representative.
798	System Error. Memory test failed. (#3)	A memory error was detected. Contact a sales representative.

ALPHABETICAL INDEX

[Numerics]		
3GPP	3-7, 3-19, 3-57	Average Type
3GPP modulation analysis mode	7-2	3-7, 3-25, 3-88
45deg Turn	3-19, 3-61	
[A]		[B]
Accessories	1-1	Band Conversion
Active CH. Detection	3-20, 3-65, 3-69	3-17
Analysis Rate	3-20, 3-21, 3-65, 3-71	Baseband Input
Auto Level Set	3-8, 3-9, 3-10, 3-11, 3-12, 3-13, 3-14, 3-16, 3-17, 3-18, 3-19, 3-22, 3-23, 3-24, 3-28, 3-31, 3-34, 3-37, 3-40, 3-42, 3-45, 3-49, 3-52, 3-55, 3-57, 3-76, 3-79, 3-80, 3-83, 3-84, 3-86	3-7, 3-25, 3-88
Average Mode	3-8, 3-9, 3-10, 3-11, 3-12, 3-13, 3-15, 3-16, 3-17, 3-18, 3-31, 3-33, 3-36, 3-40, 3-41, 3-44, 3-48, 3-51, 3-54, 3-56	[C]
Average Times ON/OFF	3-8, 3-9, 3-10, 3-11, 3-12, 3-13, 3-14, 3-16, 3-17, 3-18, 3-19, 3-22, 3-24, 3-30, 3-33, 3-35, 3-39, 3-40, 3-43, 3-47, 3-50, 3-53, 3-55, 3-75, 3-78, 3-80,	Calibration
		1-1
		CCDF
		3-7, 3-23, 3-83
		CCDF Measurement
		2-31
		Channel Setting
		3-7, 3-25, 3-87
		Code
		3-19, 3-59, A-1
		Communication Systems
		3-27
		Config
		3-8, 3-9, 3-10, 3-11, 3-12, 3-13, 3-14, 3-16, 3-17, 3-18, 3-30, 3-33, 3-35, 3-39, 3-40, 3-43, 3-47, 3-50, 3-53, 3-55
		Connectors
		1-2
		Constellation
		3-19, 3-22, 3-60, 3-76
		Constellation(Dot)
		3-19, 3-22, 3-60, 3-61, 3-76
		Constellation(Line & Chip)
		3-19, 3-22, 3-60, 3-76
		Constellation(Line & Symbol)
		3-61
		Constellation(Line)
		3-19, 3-22, 3-60, 3-61, 3-76
		Cont Auto Level Set
		3-7, 3-25, 3-88
		Copy from STD
		3-7, 3-13, 3-14, 3-16, 3-17, 3-18, 3-25, 3-42, 3-47, 3-49, 3-50, 3-52, 3-55, 3-87

Alphabetical Index

[D]			
DC CAL	3-7, 3-25, 3-87	Due to Transient	
Delay Time	3-8, 3-9, 3-10, 3-11, 3-14, 3-29, 3-32, 3-34, 3-38, 3-45	3-7, 3-42, 5-4, 5-5	
Delete	3-18	[E]	
Delete Line	3-8, 3-10, 3-13, 3-14, 3-16, 3-17, 3-30, 3-35, 3-42, 3-47, 3-49, 3-50, 3-52, 3-53, 3-55	E.V.M. vs Chip	3-19, 3-22, 3-60, 3-77
Demod Data Save	3-19, 3-61	E.V.M. vs Symbol	3-19, 3-59, 3-61
Detector	3-8, 3-9, 3-10, 3-11, 3-12, 3-13, 3-14, 3-15, 3-16, 3-17, 3-18, 3-30, 3-33, 3-35, 3-38, 3-39, 3-41, 3-43, 3-46, 3-47, 3-50, 3-53, 3-56	Ext Gate	3-11, 3-14, 3-38, 3-46
Display	3-19, 3-57	EXT Trigger Delay	3-20, 3-21, 3-22, 3-65, 3-68, 3-71, 3-73, 3-78, 3-79
Display Start	3-19, 3-22, 3-59, 3-76	EXT Trigger Level	3-7, 3-25, 3-89
Display Type	3-19, 3-23, 3-57, 3-80	EXT Trigger Slope	3-20, 3-21, 3-22, 3-65, 3-68, 3-71, 3-73, 3-77, 3-79
Display Unit	3-8, 3-9, 3-10, 3-11, 3-13, 3-15, 3-16, 3-17, 3-18, 3-30, 3-33, 3-35, 3-39, 3-44, 3-48, 3-51, 3-54, 3-56	EXT Trigger Source	3-7, 3-25, 3-89
Down Link Measurement in IQ Input	6-10	[F]	
Down Link Measurement in RF Input	6-5	F-Domain	3-7, 3-37
DOWNLINK	7-2	Format	3-19, 3-57
DPCCH No.	3-21, 3-71, 3-73	Freq. Setting	3-13, 3-15, 3-16, 3-17, 3-43, 3-47, 3-50, 3-53
DPCCH SF	3-21, 3-71, 3-73	Frequency Error	3-20, 3-21, 3-67, 3-72
Due to Modulation	3-7, 3-45, 5-4, 5-5	Frequency Input	3-7, 3-25, 3-88
		Functional Description	3-26
		[G]	
		Gain Cal	3-7, 3-25, 3-87
		Gate Position	3-11, 3-14, 3-38, 3-46
		Gate Setup	3-11, 3-14, 3-37, 3-38, 3-45, 3-46
		Gate Source	3-11, 3-14, 3-38, 3-46
		Gate Width	3-11, 3-14, 3-38, 3-46
		Gated Sweep	3-11, 3-39
		Gated Sweep ON/OFF	3-11, 3-14,

- GPIB Command Index 3-38, 3-46
 Graph Plot Type 4-1
 Graphical Display of
 W-CDMA Measurements 3-23, 3-82
 Graphics 2-16
 3-19, 3-22,
 3-59, 3-76
- [I]**
- I EYE Diagram 3-19, 3-22,
 3-59, 3-60,
 3-61, 3-76
 I/Q EYE Diagram 3-19, 3-22,
 3-60, 3-61,
 3-77
 I/Q input 7-3
 Ich & Qch Time 3-24
 Ich Time & FFT 3-24
 Inband Spurious 5-4, 5-6
 Inband Spurious (1) 3-7, 3-16,
 3-49
 Inband Spurious (2) 3-7, 3-17,
 3-52
 Inband Spurious Modes 5-5
 Input 3-7, 3-25,
 3-88
 Insert Line 3-8, 3-10,
 3-13, 3-14,
 3-16, 3-17,
 3-18, 3-29,
 3-35, 3-42,
 3-47, 3-49,
 3-50, 3-52,
 3-55
 Integral Band 3-17, 3-54
 INTRODUCTION 1-1
 IQ Complex FFT 3-24
- [J]**
- Judgment 3-8, 3-9,
 3-10, 3-11,
 3-12, 3-13,
 3-15, 3-16,
 3-17, 3-18,
 3-22, 3-30,
 3-33, 3-36,
 3-39, 3-41,
 3-44, 3-48,
 3-51, 3-54,
 3-56, 3-78
- [L]**
- Limit (ρ) 3-22, 3-78
 Limit Setup 3-22, 3-78
 Link 3-7, 3-25,
 3-88
 Load Table 3-10, 3-18,
 3-35, 3-55
 Lower Limit 3-8, 3-11,
 3-12, 3-31,
 3-39, 3-41
- [M]**
- Mag Error vs Chip 3-19, 3-22,
 3-60, 3-77
 Mag Error vs Symbol 3-61
 Margin ΔX ON/OFF 3-13, 3-14,
 3-16, 3-17,
 3-42, 3-46,
 3-49, 3-52
 Marker Edit 3-13, 3-14,
 3-16, 3-17,
 3-42, 3-47,
 3-50, 3-52
 Marker Edit Function 5-4
 Marker Setup 3-23, 3-82
 Meas Branch 3-21, 3-74
 Meas Channel No. 3-20, 3-21,
 3-69, 3-73
 Meas Channel SF 3-20, 3-21,
 3-69, 3-73
 Meas Frame 3-24, 3-85
 Meas Length 3-23, 3-82,
 3-84
 Meas Mode 3-7, 3-20,
 3-21, 3-23,
 3-25, 3-64,
 3-70, 3-81,
 3-87
 Meas Range 3-22, 3-77
 Meas Slots 3-20, 3-21,
 3-69, 3-74
 Meas Start Position 3-20, 3-21,
 3-66, 3-69,
 3-72, 3-74
 Meas Unit 3-20, 3-21,
 3-66, 3-71
 MEASUREMENT EXAMPLES 2-1
 Measuring 2-6
 Measuring a QPSK Signal 2-21
 Measuring of the Frame 2-13
 Measuring Power Variations
 Using the External Trigger 2-24

Alphabetical Index

Measuring Power Variations
 Using the IF Trigger 2-27
 Measuring the BTS 3GPP Signals 2-1
 Measuring the Frame 2-6
 Measuring the MS 3GPP Signal 2-9
 Measuring the Slot 2-1, 2-9
 Menu Index 3-1
 Menu Map 3-7
 Messages A-1
 Modulation 3-7, 3-57
 Modulation Analysis Compliance 7-1
 Multi Channel No. 3-19, 3-62
 Multiplier 3-10, 3-35

[O]

OBW 3-7, 3-40
 OBW% 3-12, 3-40
 OFF Position 3-9, 3-32
 OFF Width 3-9, 3-32
 Offset Level 3-7, 3-25, 3-88
 Omit Transient Section for AVG Power . 3-23, 3-82
 ON Position 3-9, 3-32
 ON Width 3-9, 3-32
 ON/OFF Ratio 3-7, 3-9, 3-31
 Outband Spurious 3-7, 3-55

[P]

Page 3-19, 3-59
 Parameter Setup 3-8, 3-9, 3-10, 3-11, 3-12, 3-13, 3-14, 3-16, 3-17, 3-18, 3-19, 3-22, 3-23, 3-24, 3-30, 3-33, 3-35, 3-39, 3-41, 3-43, 3-47, 3-50, 3-53, 3-55, 3-63, 3-77, 3-79, 3-81, 3-83, 3-84, 3-86
 P-CPICH Power 3-24, 3-84
 Peak CDE 3-20, 3-64
 Peak MKR Y Delta 3-10, 3-16, 3-17, 3-18, 3-35, 3-50, 3-53, 3-56

PERFORMANCE VERIFICATION TEST

(3GPP) 6-1
 Phase Error vs Chip 3-19, 3-22, 3-60, 3-77
 Phase Error vs Symbol 3-61
 Phase Inverse 3-20, 3-21, 3-67, 3-70, 3-72, 3-75
 Power 3-7, 3-22, 3-23, 3-24, 3-79
 Power (F-Domain) 3-37
 Power (T-Domain) 3-28
 Power Marker 1 3-23, 3-82
 Power Marker 2 3-23, 3-82
 Power Unit 3-23, 3-80, 3-83
 Power vs Time 2-24, 3-7, 3-23, 3-80
 Preselector 3-10, 3-18, 3-36, 3-56
 Primary CPICH No. 3-20, 3-65, 3-69
 Primary CPICH SF 3-20, 3-65, 3-69
 Product Overview 1-1

[Q]

Q EYE Diagram 3-19, 3-22, 3-59, 3-60, 3-61, 3-77
 Qch Time & FFT 3-24
 QPSK 3-7, 3-22, 3-76
 QPSK Measurement in IQ Input 6-13
 QPSK Measurement in RF Input 6-8
 QPSK modulation analysis mode 7-1

[R]

Ref Power 3-13, 3-15, 3-16, 3-17, 3-43, 3-48, 3-51, 3-53
 REFERENCE 3-1
 REMOTE CONTROL 4-1
 Result 3-10, 3-13, 3-15, 3-16, 3-17, 3-35, 3-43, 3-48, 3-50, 3-53
 Rolloff Factor 3-13, 3-15, 3-44, 3-48

Root Nyquist	3-22, 3-23, 3-77, 3-79, 3-81, 3-84	Sort	3-8, 3-13, 3-14, 3-16, 3-17, 3-30, 3-42, 3-47, 3-50, 3-52, 3-53
[S]		SPECIFICATIONS	7-1
Save Table	3-10, 3-18, 3-35, 3-55	Spurious	3-7
Scale Setup	3-23, 3-80, 3-83	Spurious (T-Domain)	3-34
SCH Power	3-19, 3-61	Start Offset	3-17, 3-54
Scrambling Code Define	3-20, 3-64, 3-67	STD	3-7, 3-25, 3-87
Scrambling Code No.	3-20, 3-21, 3-24, 3-64, 3-68, 3-71, 3-73, 3-85	STD Setup	3-7, 3-25, 3-87
Search Mode	3-20, 3-24, 3-65, 3-68, 3-85	Stop Offset	3-17, 3-54
Select Type	3-19, 3-22, 3-24, 3-59, 3-76, 3-86	Symbol Rate 1/T	3-13, 3-15, 3-44, 3-48
Self Test Function	1-1	System Parameters	7-1
Set to Default	3-10, 3-18, 3-36, 3-56	[T]	
Set to STD	3-8, 3-9, 3-11, 3-12, 3-13, 3-14, 3-16, 3-17, 3-29, 3-31, 3-32, 3-33, 3-38, 3-39, 3-40, 3-41, 3-44, 3-46, 3-49, 3-51, 3-55	Table Edit	3-10, 3-18, 3-19, 3-35, 3-55, 3-62
SF/Number/Rate	3-19, 3-62	Table Init	3-8, 3-10, 3-13, 3-14, 3-16, 3-17, 3-18, 3-30, 3-35, 3-42, 3-43, 3-47, 3-50, 3-52, 3-53, 3-55
Shift X	3-8, 3-13, 3-14, 3-16, 3-17, 3-29, 3-42, 3-46, 3-49, 3-52	Table No. 1/2/3	3-10, 3-18, 3-34, 3-35, 3-55
Shift Y	3-8, 3-13, 3-14, 3-16, 3-17, 3-29, 3-42, 3-46, 3-49, 3-52	T-Domain	3-7, 3-28
Simplified Performance Check	6-14	TECHNICAL INFORMATION	5-1
Slope	3-8, 3-9, 3-10, 3-11, 3-14, 3-29, 3-32, 3-34, 3-37, 3-45	Template	3-8, 3-13, 3-14, 3-16, 3-17, 3-29, 3-42, 3-46, 3-49, 3-52
		Template 1	3-23, 3-83
		Template 2	3-23, 3-83
		Template Couple to Power	3-8, 3-13, 3-15, 3-16, 3-17, 3-30, 3-44, 3-48, 3-51, 3-54
		Template Edit	3-8, 3-13, 3-14, 3-16, 3-17, 3-29, 3-42, 3-46, 3-49, 3-52

[Y]

Y Scale	3-19, 3-57
Y Scale [dB/div] 10/5/2	3-8, 3-9, 3-11, 3-30, 3-32, 3-39
Y Scale Range	3-23, 3-80
Y Scale Upper	3-23, 3-80

IMPORTANT INFORMATION FOR ADVANTEST SOFTWARE

PLEASE READ CAREFULLY: This is an important notice for the software defined herein. Computer programs including any additions, modifications and updates thereof, operation manuals, and related materials provided by ADVANTEST (hereafter referred to as "SOFTWARE"), included in or used with hardware produced by ADVANTEST (hereafter referred to as "PRODUCTS").

SOFTWARE License

All rights in and to the SOFTWARE (including, but not limited to, copyright) shall be and remain vested in ADVANTEST. ADVANTEST hereby grants you a license to use the SOFTWARE only on or with ADVANTEST PRODUCTS.

Restrictions

- (1) You may not use the SOFTWARE for any purpose other than for the use of the PRODUCTS.
- (2) You may not copy, modify, or change, all or any part of, the SOFTWARE without permission from ADVANTEST.
- (3) You may not reverse engineer, de-compile, or disassemble, all or any part of, the SOFTWARE.

Liability

ADVANTEST shall have no liability (1) for any PRODUCT failures, which may arise out of any misuse (misuse is deemed to be use of the SOFTWARE for purposes other than it's intended use) of the SOFTWARE. (2) For any dispute between you and any third party for any reason whatsoever including, but not limited to, infringement of intellectual property rights.

LIMITED WARRANTY

1. Unless otherwise specifically agreed by Seller and Purchaser in writing, ADVANTEST will warrant to the Purchaser that during the Warranty Period this Product (other than consumables included in the Product) will be free from defects in material and workmanship and shall conform to the specifications set forth in this Operation Manual.
2. The warranty period for the Product (the "Warranty Period") will be a period of one year commencing on the delivery date of the Product.
3. If the Product is found to be defective during the Warranty Period, ADVANTEST will, at its option and in its sole and absolute discretion, either (a) repair the defective Product or part or component thereof or (b) replace the defective Product or part or component thereof, in either case at ADVANTEST's sole cost and expense.
4. This limited warranty will not apply to defects or damage to the Product or any part or component thereof resulting from any of the following:
 - (a) any modifications, maintenance or repairs other than modifications, maintenance or repairs (i) performed by ADVANTEST or (ii) specifically recommended or authorized by ADVANTEST and performed in accordance with ADVANTEST's instructions;
 - (b) any improper or inadequate handling, carriage or storage of the Product by the Purchaser or any third party (other than ADVANTEST or its agents);
 - (c) use of the Product under operating conditions or environments different than those specified in the Operation Manual or recommended by ADVANTEST, including, without limitation, (i) instances where the Product has been subjected to physical stress or electrical voltage exceeding the permissible range and (ii) instances where the corrosion of electrical circuits or other deterioration was accelerated by exposure to corrosive gases or dusty environments;
 - (d) use of the Product in connection with software, interfaces, products or parts other than software, interfaces, products or parts supplied or recommended by ADVANTEST;
 - (e) the occurrence of an event of force majeure, including, without limitation, fire, explosion, geological change, storm, flood, earthquake, tidal wave, lightning or act of war; or
 - (f) any negligent act or omission of the Purchaser or any third party other than ADVANTEST.
5. **EXCEPT TO THE EXTENT EXPRESSLY PROVIDED HEREIN, ADVANTEST HEREBY EXPRESSLY DISCLAIMS, AND THE PURCHASER HEREBY WAIVES, ALL WARRANTIES, WHETHER EXPRESS OR IMPLIED, STATUTORY OR OTHERWISE, INCLUDING, WITHOUT LIMITATION, (A) ANY WARRANTY OF MERCHANTABILITY OR FITNESS FOR A PARTICULAR PURPOSE AND (B) ANY WARRANTY OR REPRESENTATION AS TO THE VALIDITY, SCOPE, EFFECTIVENESS OR USEFULNESS OF ANY TECHNOLOGY OR ANY INVENTION.**
6. **THE REMEDY SET FORTH HEREIN SHALL BE THE SOLE AND EXCLUSIVE REMEDY OF THE PURCHASER FOR BREACH OF WARRANTY WITH RESPECT TO THE PRODUCT.**
7. **ADVANTEST WILL NOT HAVE ANY LIABILITY TO THE PURCHASER FOR ANY INDIRECT, INCIDENTAL, SPECIAL, CONSEQUENTIAL OR PUNITIVE DAMAGES, INCLUDING, WITHOUT LIMITATION, LOSS OF ANTICIPATED PROFITS OR REVENUES, IN ANY AND ALL CIRCUMSTANCES, EVEN IF ADVANTEST HAS BEEN ADVISED OF THE POSSIBILITY OF SUCH DAMAGES AND WHETHER ARISING OUT OF BREACH OF CONTRACT, WARRANTY, TORT (INCLUDING, WITHOUT LIMITATION, NEGLIGENCE), STRICT LIABILITY, INDEMNITY, CONTRIBUTION OR OTHERWISE.**

CUSTOMER SERVICE DESCRIPTION

In order to maintain safe and trouble-free operation of the Product and to prevent the incurrence of unnecessary costs and expenses, ADVANTEST recommends a regular preventive maintenance program under its maintenance agreement.

ADVANTEST's maintenance agreement provides the Purchaser on-site and off-site maintenance, parts, maintenance machinery, regular inspections, and telephone support and will last a maximum of ten years from the date the delivery of the Product. For specific details of the services provided under the maintenance agreement, please contact the nearest ADVANTEST office listed at the end of this Operation Manual or ADVANTEST's sales representatives.

Some of the components and parts of this Product have a limited operating life (such as, electrical and mechanical parts, fan motors, unit power supply, etc.). Accordingly, these components and parts will have to be replaced on a periodic basis. If the operating life of a component or part has expired and such component or part has not been replaced, there is a possibility that the Product will not perform properly. Additionally, if the operating life of a component or part has expired and continued use of such component or part damages the Product, the Product may not be repairable. Please contact the nearest ADVANTEST office listed at the end of this Operation Manual or ADVANTEST's sales representatives to determine the operating life of a specific component or part, as the operating life may vary depending on various factors such as operating condition and usage environment.

CLAIM FOR DAMAGE IN SHIPMENT TO ORIGINAL BUYER

The product should be thoroughly inspected immediately upon original delivery to buyer. All material in the container should be checked against the enclosed packing list or the instruction manual alternatively. ADVANTEST will not be responsible for shortage unless notified immediately.

If the product is damaged in any way, a claim should be filed by the buyer with carrier immediately. (To obtain a quotation to repair shipment damage, contact ADVANTEST or the local supplier.) Final claim and negotiations with the carrier must be completed by buyer.

SALES & SUPPORT OFFICES

Advantest America Measuring Solutions, Inc. (North America)

New Jersey Office

258 Fernwood Avenue, Edison, NJ 08837

Phone: (1) (732) 346-2600 Facsimile: (1) (732) 346-2610

Santa Clara Office

3201 Scott Blvd., Santa Clara, CA 95054

Phone: (1) (408) 988-7700 Facsimile: (1) (408) 987-0688

ROHDE & SCHWARZ Engineering and Sales GmbH (Europe)

Mühlendorfstraße 15, D-81671 München, Germany

P.O.B. 80 14 29, D-81614 München, Germany

Phone: (49) (89) 4129-13711 Facsimile: (49) (89) 4129-13723

Advantest (Singapore) Pte. Ltd. (Singapore)

438A Alexandra Road, #8-03/06

Alexandra Technopark, Singapore 119967

Phone: (65) (6) 274-3100 Facsimile: (65) (6) 274-4055

Advantest Korea Co., Ltd. (Korea)

16Fl., MIRAEWASARAM Bldg., 942-1

Daechi-Dong, Kangnam-Ku, Seoul, Korea

Phone: (82) (02) 3452-7710 Facsimile: (82) (02) 3452-7970

Advantest (Suzhou) Co., Ltd. (China)

5F, No. 46 Factory Building,

No. 555 Gui Ping Road, Shanghai, China 200233

Phone: (86) (21) 6485-2725 Facsimile: (86) (21) 6485-2726

Technology Support on the Leading Edge

ADVANTEST®

ADVANTEST CORPORATION

Shinjuku-NS Building, 4-1, Nishi-Shinjuku 2-chome, Shinjuku-ku, Tokyo 163-0880, Japan
Phone:+81-3-3342-7500 Facsimile:+81-3-5322-7270 Telex:232-4914 ADVAN J